



WORKPLACE EQUIPMENT

 **Screwdriving technology**

 **Workspace Organisation**

 **Safety & Ergonomics**



Your Assembly Workspace Partner

Workspaces for happier workfaces

About us	4
Industrial ergonomics	6
ESD protection	12
LEAN thinking	14
Customised workstation solutions	16
Environmental actions	18
Decorating with colour	20

1. Workbenches	21
Concept - the most versatile workbench	24
WB - aesthetic and easily adaptable	30
TED - electric desk for industrial use	34
Quick Edge - extremely fast height adjustment	38
TP - ideal basic workbench	40
TPH - standard workbench with one shelf	46
TPB - efficient packing bench	50
Workshop - sturdy, heavy-duty workbench	52

2. Workbench accessories	56
Concept, TED, Quick Edge, TP, Workshop	57
WB	74
TPH and TPB	79
Accessories that suit all benches	84
Packing material roll stands and cutters	88

3. Lighting	90
--------------------	-----------

4. Chairs	97
------------------	-----------

5. Trolleys	104
Ergonomics for manual handling of loads	106
Universal trolley WTR	112
Treston Industrial Multi trolley	113
Adjustable trolley TRTA	116
Reel holder trolley RRT	117
Mobile workstations	118
Trolleys for additional workspace	119
Packing trolleys	120
Heavy-duty trolley	122
Fitter's trolley	123
Tool trolley	124
Service trolley	126
Bin and cabinet trolley	128

6. Drawer units	130
Light steel cabinet LMC	132
Drawer units 30 and 35	133
Drawer unit 45	134
Drawer unit 55	138
Drawer unit 71	142
Drawer units 70, 90 and 130	144

7. Storage systems	158
FiFo Flow Rack	159
Shelving system	164
Heavy shelving system	167
Shelving cabinets	170
Industrial cabinets	172
Perforated panels	177
Tool storage systems	180
Panel hooks	184
Small-parts storage cabinets	191
Spacemisers for small-parts storage cabinets	193
Storage bin cabinets	194
Spacemisers for storage bin cabinets	195
High density storage cabinets	196
Shelf bins	197
Stacking bins	202
Storage and picking bins	205
Small drawers	206
Stacking bin racks	207

8. Spare parts	210
-----------------------	------------



TRESTON

WORKSPACES FOR HAPPIER WORKFACES

WORKSPACES FOR HAPPIER WORKFACES

There's no way around it. Sustainable long term business success in every industry is founded on empowered, motivated and healthy employees, and hyper adaptability to constant change.

The solution is simple.

A smart industrial workspace that adapts flexibly to the needs of the individual and the constant changes in the process. A next generation workstation and material flow solution that drives better business performance, environmental performance and personal performance by integrating and optimizing all work phases into a leaner, cleaner and greener process.

With decades of experience, in depth understanding of ergonomics in industrial environments, unmatched ESD competence and proven LEAN knowhow we at Treston are in a unique position to help our customers in keeping their business and people in good shape.

Workspaces for happier workfaces.

This is our aspiration. This is our promise. This is what Treston is all about.





600,000+ workstations
delivered

50+ years of ergonomic
workspace development and
manufacturing

30+ countries,
global footprint

Industrial ergonomics



Have you paid attention to the methods of transferring objects, the placement and accessibility of tools, the opportunities to perform one's work either sitting down or standing up, and lighting at your workplace? All of the above are part of ergonomic workstation design, and companies that have paid attention to these have been able to significantly improve their productivity.

However, good ergonomics means more than the ability to adjust a workstation's furniture. Improving ergonomics requires knowing the work process from start to finish, but most importantly, identifying the individual needs of the job

and the employee. Developing the working environment and working methods pays off, as it helps the company reduce the amount of sick leave and the number of accidents at work, improve the quality of work, and increase efficiency and production volumes. Employees who work in a pleasant environment are more energetic and productive.

DEFINITION OF ERGONOMICS

"The word ergonomics — "the science of work" is derived from the Greek ergon (work) and nomos (laws). Ergonomics (or human factors) is the scientific discipline concerned with the understanding of interactions among humans and other elements of a system, and the profession that applies theory, principles, data, and methods to design in order to optimize human well-being and overall system performance."

Why should you invest in ergonomics?

Musculoskeletal disorders (MSDs) affect most employees. According to European Agency for Safety and Health at Work musculoskeletal disorders (MSDs) are the single largest occupational health hazard in Europe: up to three out of five employees report musculoskeletal symptoms. In addition, Confederation of Finnish Industries has reported that employees in the industrial sector have the most absences due to sickness, on average 16 working days per person/year.

Proper ergonomics can reduce MSD-related absences and improve productivity resulting in significant annual savings. A study estimating the effectiveness of ergonomics interventions revealed that musculoskeletal symptoms and disorders were reduced 57% and absences due to MSDs reduced 72% as a result of measures that improve ergonomics. The above mentioned study on the effectiveness of ergonomics interventions concluded that productivity improved 46% through measures that improved ergonomics.

Indeed there are several aspects that proper ergonomics can have a positive impact on in the long run. The benefits of proper ergonomics are both for the employer and for the employee.

Benefits of ergonomics to the EMPLOYER

- Improves occupational safety and reduces sickness absences
- Improves employees' performance
- Reduces occupational health care costs
- Increases productivity and efficiency
- Motivates and engages employees

Benefits of ergonomics to the EMPLOYEE

- Improves employees' health and well-being
- Healthy and safe working environments promote the ability to work and also have a positive effect on the ability to function during leisure time
- More satisfaction for your work



How to improve the ergonomics of your workspace?

Below you will find a list of the five key factors that you can use to improve the ergonomics of your industrial workstations.

1. Have everything you need close by

When sizing your workstations, make sure that the necessary equipment and furniture are right where they need to be. This includes ensuring that there is sufficient space for various work tasks and that you can easily switch between each task. Remember to pay attention to the purpose of each workspace, as a functional and efficient space is also a safe one.

When planning the layout of your furniture and equipment, ensure that all the devices and materials you need are readily available and easy to reach. Any infrequently used materials can be stored on a shelf or auxiliary top or in a drawer, for example. A carefully planned workspace is also a productive one.

2. Have enough adjustable lighting at your disposal

Your eyes are just as sensitive to your working conditions as the rest of your body. That's why you need to be able to adjust your lighting to each task at hand. Make sure that sufficient lighting is available for each work phase and task. Any tasks that demand a great deal of accuracy for longer periods of time, such as quality control or assembly work, usually require lots of light as well.

When your light source is both sufficiently powerful and correctly directed, it can provide the lighting and contrast you need – regardless of personal preference or the accuracy demanded by each task.

3. Handle your loads carefully

You may think that lifting a 20–25 kg package does not sound like much of a challenge, but manually handling even these types of smaller loads can result in back problems and many other adverse effects to your health. In general, the manual handling of loads represents a major occupational risk that can lead to injuries to the lower back and shoulders. To ensure the health, safety and efficiency of you and your employees, pay particular attention to how loads are handled at your place of work.

To guarantee the efficiency and ergonomics of your workplace, choose the right trolley or mobile auxiliary top for transporting any larger loads, and instruct your employees on the correct techniques for handling loads.

4. Adjust your working posture regularly

Make sure that you vary your working posture throughout the day. It's never a good idea to remain in the same position all the time, no matter if you're seated or standing - so remember to change your working posture frequently. The latest cognitive research has demonstrated the benefits of regularly varying your working posture. According to the research results, even small movements, such as standing up occasionally, can help improve your memory, attentiveness, learning and overall cognitive performance.

5. Remember to adjust your chair

A chair that is designed for ergonomic working postures forms a vital part of any well-functioning, ergonomic and user-friendly workstation. Proper sitting techniques will allow you to work efficiently, reduce the risk that you will neglect to vary your posture, and permit you to operate in a way that is best for you and your work. However, an ergonomic chair is not truly ergonomic until it has been adjusted to the needs of the person using it – so remember to adjust the chair and not the employee!



Watch this animation: 6 ways to improve your workspace ergonomics
<https://vimeo.com/358783022>



Free e-book: "Increasing productivity with proper ergonomics"



This informational e-book will help you learn how ergonomic environments can have a direct influence on employee well-being, the reduction of time and waste, and ultimately, greater productivity.

treston.com/catalogues-and-brochures



Seated or standing work?

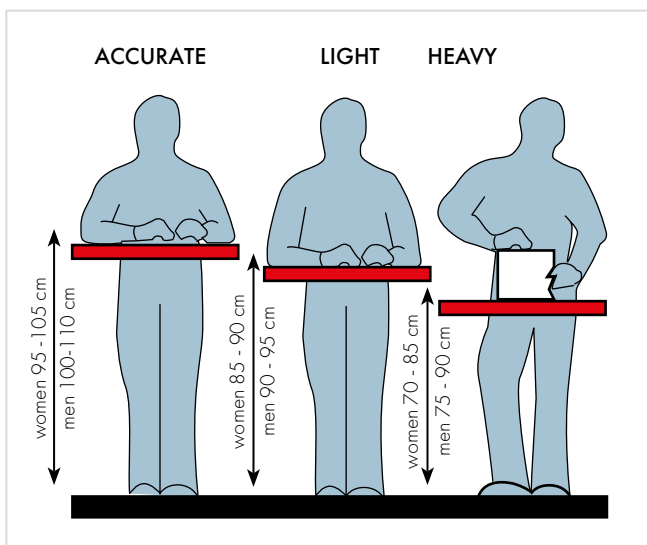

The choice of a seated or standing working position is dependent upon the task to be executed. The height of the work surface is determined by such factors as size and weight of the part, precision requirement, assembly process, repetitiveness etc.

Height adjustability is especially useful when the size of the products being handled varies or when several people use the same workstation.

Standing work

Task	Primary choice	Secondary choice
Lifting the weight over 5 kgs	Standing	Semi-sitting
Working below the elbow level	Standing	Semi-sitting
Need to reach widely in horizontal level	Standing	Semi-sitting
Light assembly work	Sitting	Semi-sitting
Precision work	Sitting	Semi-sitting
Visual monitoring or supervising	Sitting	Semi-sitting
Need to move between workstations	Semi-sitting	Standing

Semi-sitting

between sitting and standing; reduces the strain of the back due to sitting and the strain of the lower limbs due to standing.



Reaching distances and heights

To improve working postures in assembly work, the most often used parts should be placed into the optimal horizontal working area within the operator's sight. Avoid overly large or deep workbenches, which can cause improper reach and reduced productivity. Assembly work is most ergonomic when parts are within easy view and reach.

The vertical work area and reach zone can be fine-tuned with accessories. Our height adjustable arms optimize work movements and keep parts or tools within easy access. Operators can work with wrists and arms in optimal posture with shoulders relaxed. Tilted bin rails and shelves keep the wrist in a neutral position when picking parts. The tilt angle also provides easy identification of the parts with the proper viewing angle.

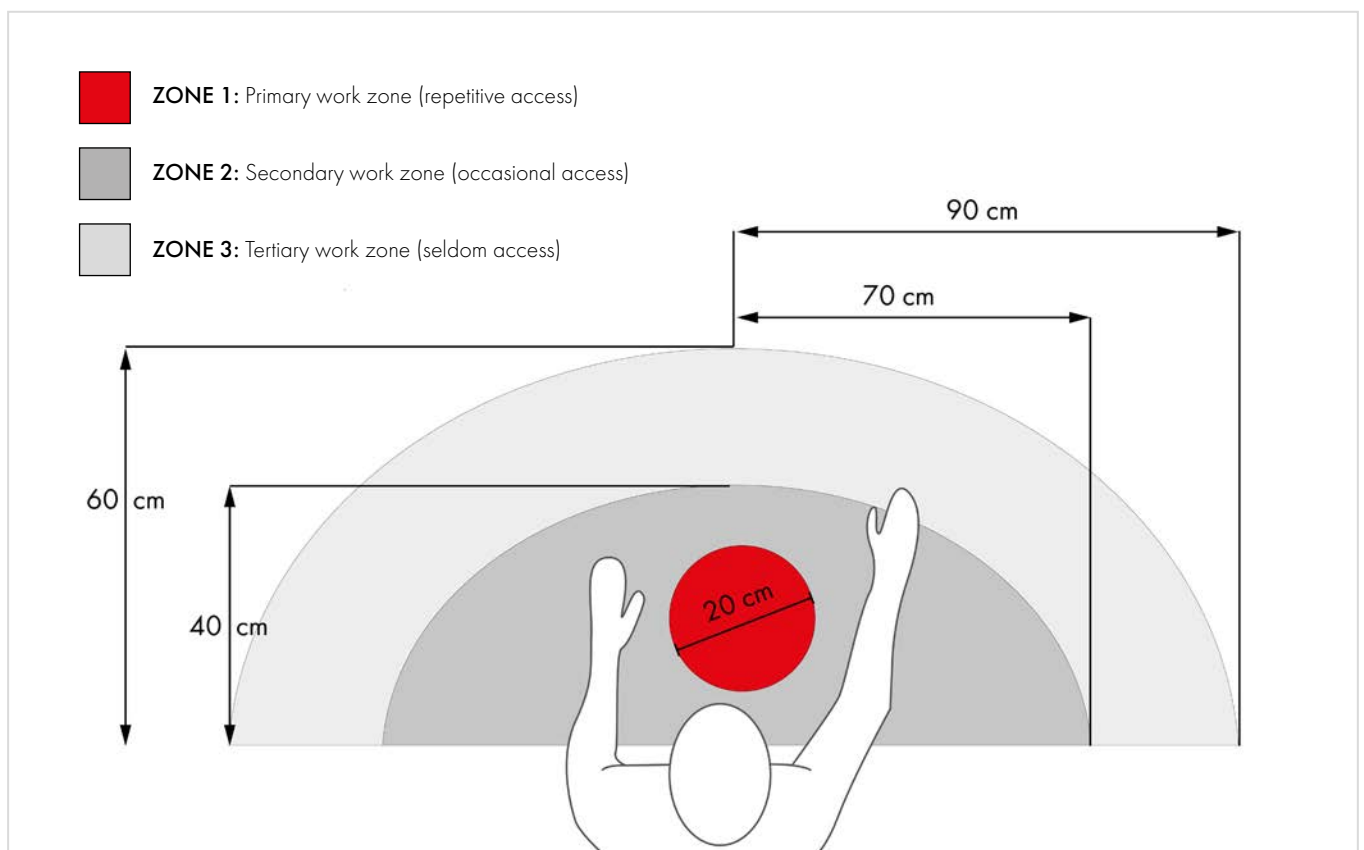
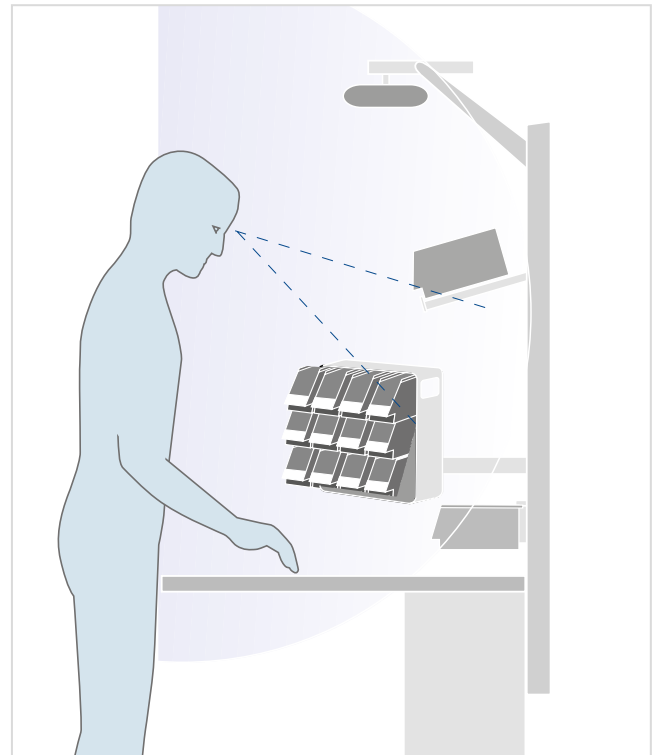

Ergonomic workzones

ESD protection guarantees a safe working environment



Particularly in the electronics industry, work is often carried out in an ESD protected area (EPA) that is protected from static discharge. To create and maintain an EPA one needs to pay special attention to furniture and personnel, which need to be grounded. Protection can involve earthing equipment and painting the frame of the workstation with semi-conductive paint.

We have extensive experience in developing, manufacturing and supplying ESD furnishings. All our workstations and related products are available with an electrically semi-conductive coat of paint and we supply furnishings, seats and earthing components for ESD-protected workstations. We also build complete production systems equipped with ESD-protection. Our ESD-protected products meet the requirements specified in the IEC 61340-5-1 standard.

STATIC ELECTRICITY

The abbreviation ESD stands for Electrostatic Discharge, a process that occurs between two objects of differing electric potential. Normally, electric charges are discharged slowly from objects' surfaces. If the difference in electric potential becomes too great, the electrical current accelerates resulting in a sudden current surge.

An ESD protected area is called an EPA. In an EPA, ESD protection must be observed in all materials, employees' clothing and air humidity. Employees in an EPA must also be earthed with protective resistance (1 Mohm) to an ESD earth.



Watch this video: ESD workstation management
<https://vimeo.com/657013937>



Investing in an EPA is important

There are two types of ESD damage in industrial and technical environments. Firstly, a fatal defect that is usually easily detected during assembly or handling, or at least through careful testing. Such products are usually not delivered to customers. Secondly, another type of ESD damage is latent damage. This is difficult to detect with

bear eyes and the product may pass all tests and function normally for some time. However, latent damage affects the performance and durability of the product and often results in poor product quality.

Static charge management of working area:

- ESD-protected workstations. Attention paid to ESD safe storing, moving and packing.
- Personnel protected with shoes, wrist straps and other needed accessories
- Staff training, work instructions and quality control
- Cleanliness of ESD-protected equipment. Dust and dirt insulate.
- Commitment to continuous improvement in static electricity management



Example of an ESD-protected area (EPA)

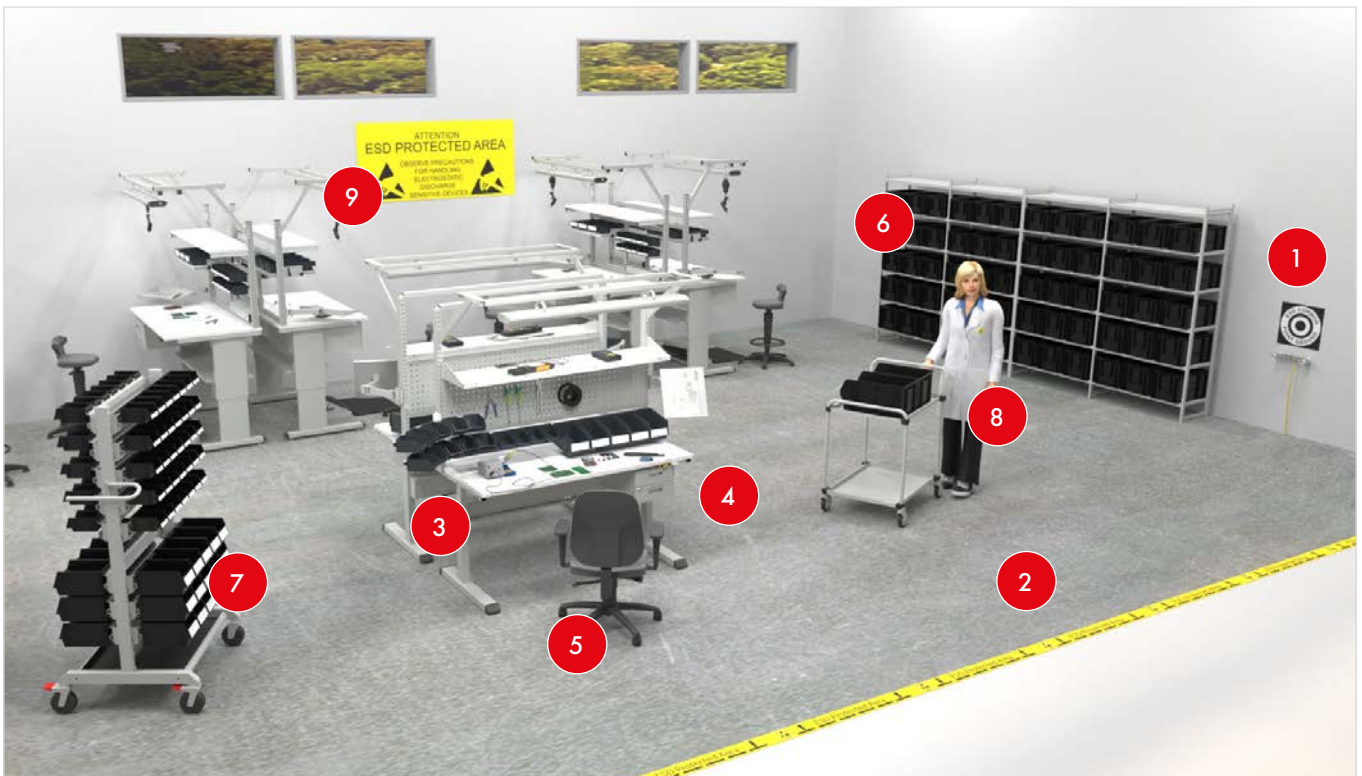

1. Common point ground
2. ESD floor
3. Semi-conductive table

4. Wrist strap + earth bounding point
5. Chair with ESD castors
6. Semi-conductive ESD shelf

7. Trolley with ESD castors
8. ESD garments (e.g. jacket and shoes)
9. EPA sign

LEAN thinking perfects production processes



Developed in the Japanese automotive industry, Lean is an operating philosophy that helps to make production smooth and efficient. Lean-based production processes and workstations are functional and task-oriented. Every item in the workstation has its own designated place, and there are no unnecessary items.

When developing operations, instead of focusing on a single task or workstation, it is better to consider the big picture and identify areas where work, time or materials are wasted. In practice, Lean involves the entire process,

including the overall order-supply chain. The Lean system is everything that adds value for the customer and helps put things in the right order. The goal is to eliminate anything that does not add value. When organising workstations according to the Lean system, the first job is to identify

- what is the product that is being made,
- what are the customer needs, and
- what is the pace at which the product needs to be manufactured.

Free e-book: "LEAN thinking perfects production processes"



This e-book will help you understand LEAN philosophy and how Treston, as a manufacturer of technical facilities and ergonomic furniture, can help you with the LEAN thinking to perfect your production processes.

treston.com/catalogues-and-brochures



Treston's ergonomic solutions for Lean and 5S environments

Full-time employees spend around 40 hours a week at their workstations, adding up to around 1700 hours a year. Employees typically spend more of their waking hours at their workstations than at any other single place. Workstations are therefore important places. They should be designed not only extremely functional from a point of view of increasing efficiency but also to be ergonomic, pleasant and comfortable to work. Designing workstations according to the principles of ergonomics and LEAN bring the best benefits to employees, employers and customers.

Ergonomic Treston products are ideally suited for use in Lean and 5S production processes. The open design of Treston workstations enables fast visual inspections while providing easy access to tools and components. Accessories can also be easily added, removed and interchanged, enhancing responsiveness and supporting continuity in operations. Tool holders, document shelves and bins help to keep the workstation tidy and well organized. From an ergonomics point of view, they can be positioned in just the right place for the employee to make performing the work as ergonomic and pleasant as possible.

Ergonomic, Lean-compatible workstations give employees an opportunity each day to perform to the best of their abilities.

Treston products are ideally suited for use in Lean and 5S production processes:

- 1 Adjustable workbenches and task chairs
- 2 Modular storage solutions
- 3 Ergonomic trolleys
- 4 Adjustable task lighting



Customised workstation solutions

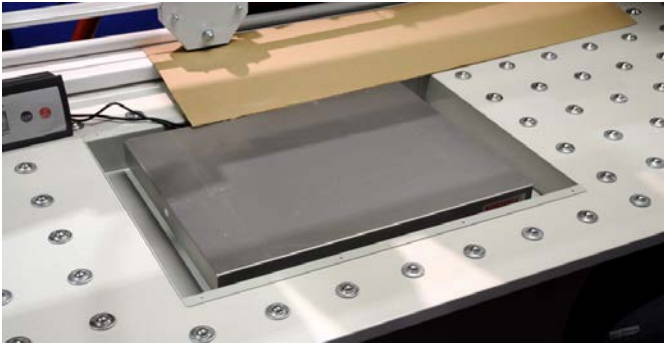

Sometimes even highly modular industrial furniture and a large selection of accessories cannot meet all the needs of a diverse and ever-evolving working environment.

We can answer customers' specific needs by offering modified versions of our workstations and storage solutions, or by designing a completely tailor-made industrial furniture solution made to the customer's specifications.

Support and advise

Our skilful and helpful sales engineers are here to help you reach the optimal workspace solution, which is ergonomic and productive, and working for your long-term success. From the initiation of a project to order processing and all the way to implementation on site, we are here for you.

Safety and ergonomics guaranteed

Treston ensures you get a safety approved and ergonomic solution. Treston's tailored solutions are based on proven concepts, and our expertise in ergonomics and ESD, as well as experienced engineering and manufacturing teams, ensure you get a risk-free solution.

Experience from various industries and applications

We have decades of know-how in designing complete workstation solutions for a wide range of industries and applications, from electronics industry's high-tech assembly applications to the specific needs of heavy industry.

Fast turn-around times

Over the years, we have established dedicated teams and streamlined our processes. Sales, the design team, and production all work smoothly together to deliver a fast turn-around time and the best customer experience. Our extensive product portfolio helps to get to a tailored solution affordably, and in-stock items ensure the project gets moving fast.

Treston offers both variations and complete custom-made solutions

A bench with tailor-made integrated FiFo system

- Treston bench with a special custom-made integrated FiFo system. Based on the versatile Concept bench model.



A trolley with custom-made tool storage

- A special trolley with custom-made tool storage. The tailor-made trolley helps to get the tools close-by the working station.

A custom-made cabinet with sliding perforated panels

- A customised industrial cabinet with sliding perforated panels to give extra storage space.

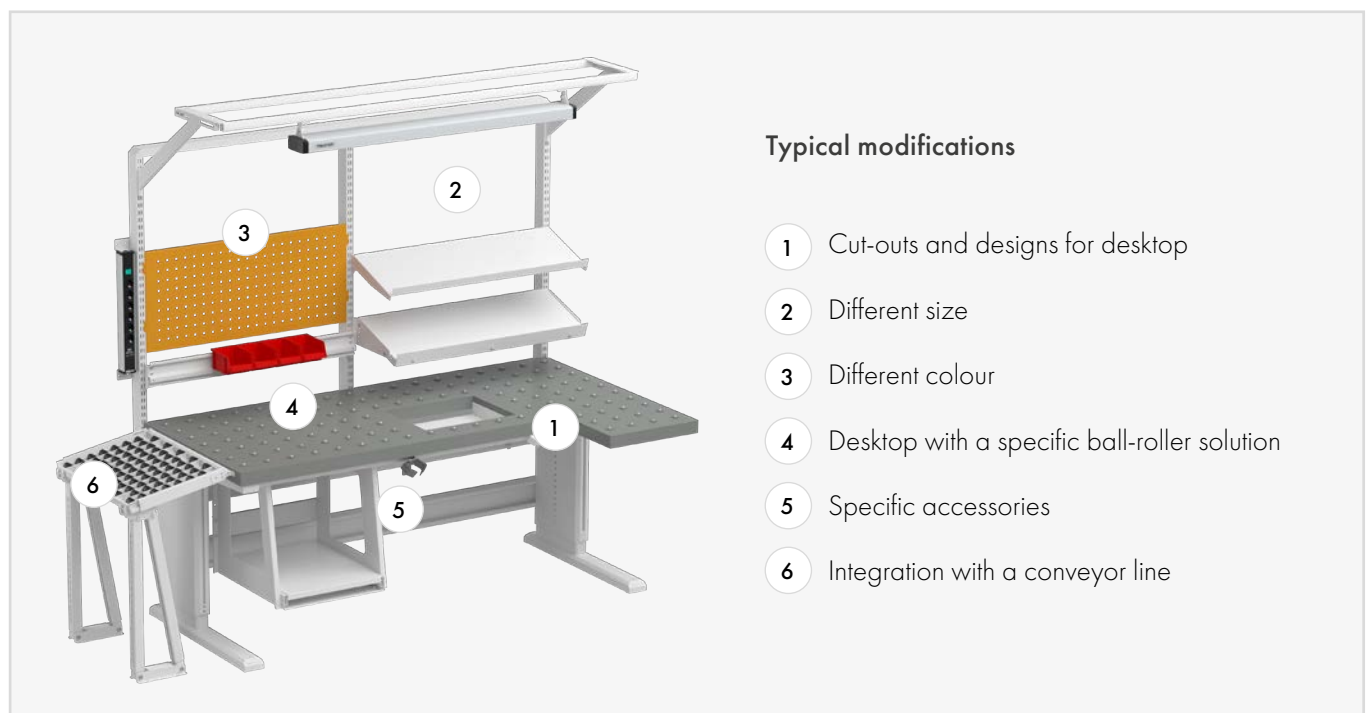
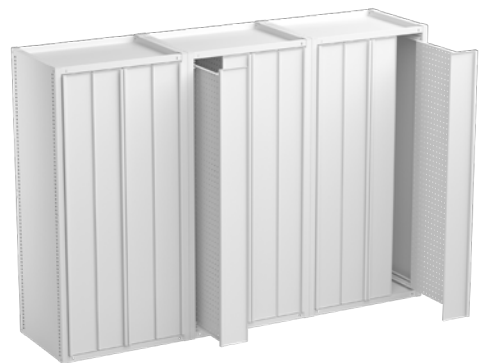

Typical modifications

- 1 Cut-outs and designs for desktop
- 2 Different size
- 3 Different colour
- 4 Desktop with a specific ball-roller solution
- 5 Specific accessories
- 6 Integration with a conveyor line

On a journey towards a carbon neutral tomorrow

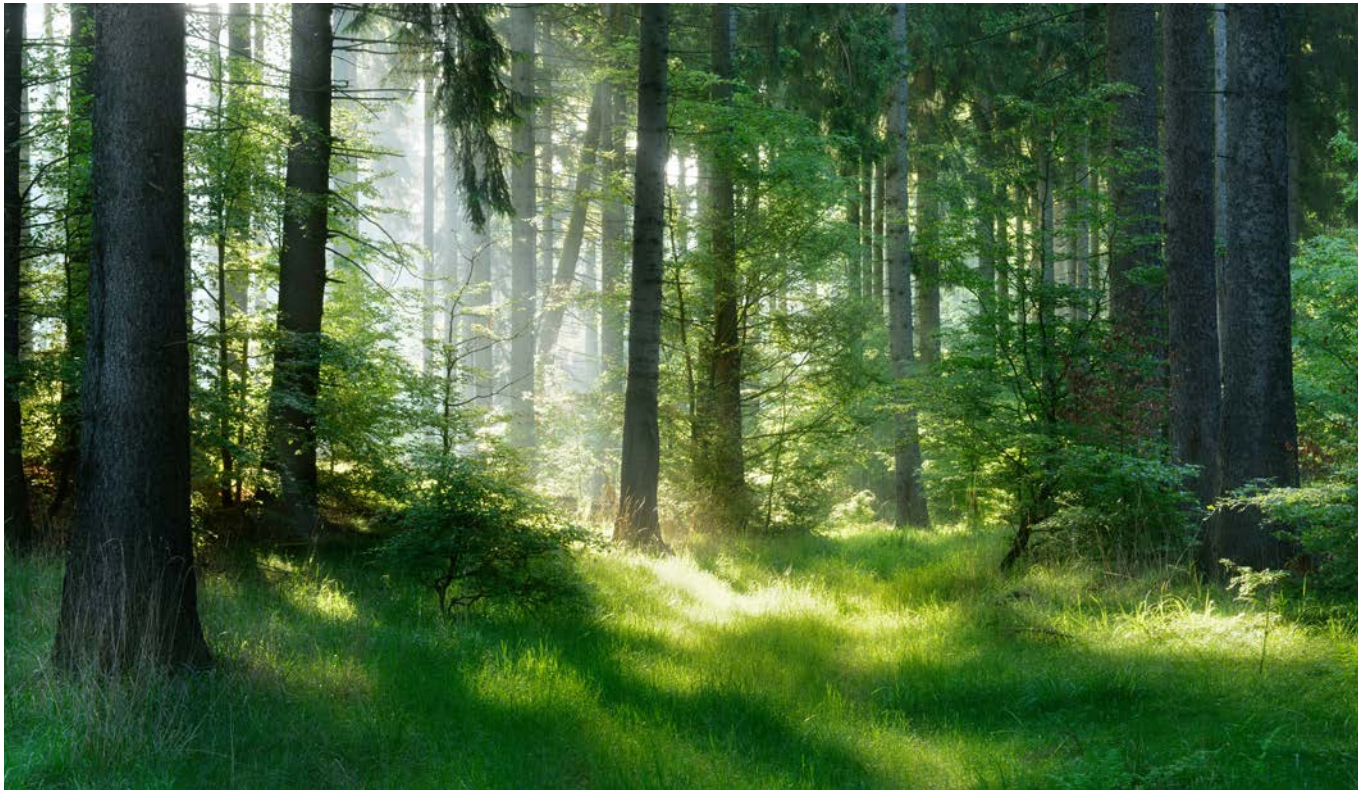

Environmental actions

Treston is the first sustainable wood-based bioplastic storage option provider for industry. In the future we aim to offer bioplastic-based alternatives for all our plastic products and parts. In addition, our long-term target is to provide 100 % carbon neutral workstation solutions. We want to play our part in a cleaner environment and making sustainable choices. We manufacture in a sustainable way high-quality products that last from one generation to another.

We follow the principle of continuous development

We aim to minimise the environmental strain of our operations as part of a continuous improvement model. We seek to promote environmental thinking within the Group,

as well as to increase the consideration of environmental aspects in all decision-making and actions. The energy and water consumption of our factories is constantly monitored, and adverse effects on the environment reduced through operational optimisation. The heat generated by our machinery is used for heating factory premises. Also, our water consumption has decreased considerably over the last few years. The plastic and steel waste generated by us is recycled 100 per cent, and we favour environmentally friendly alternatives when purchasing machinery. Additionally, the metal, plastic, and aluminium parts of our products can be recycled at the end of their useful life.

"Our long term target is to provide 100% carbon neutral workstations"

Our standards comply with the highest certification requirements

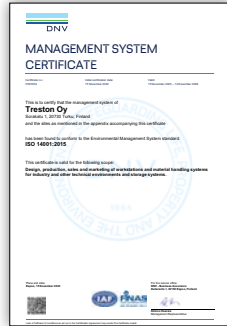

<p>Quality certification</p> <p>ISO 9001 : 2015</p>	<p>Environmental Management System certification</p> <p>ISO 14001 : 2015</p>	<p>Packaging treatment following to EU directives.</p>	<p>ESD-approval certification</p> <p>Our ESD products fulfill the basic requirements of IEC 61340-5-1.</p>	<p>GS certification for lighting</p>
--	---	---	---	---

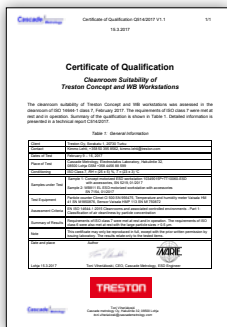

<p>Cleanroom Suitability of Treston Concept and WB Motorized Workstations</p> <p>ISO 14644-1, class 7</p>	<p>Cleanroom Suitability of Chair Treston Ergo C20PU-ESD</p> <p>ISO 14644-1, class 7</p>	<p>ESD certification</p> <p>Treston WB and Concept workstations fulfill the basic requirements of IEC 61340-5-1</p>	
--	---	--	--

To obtain a copy of our certificates, please contact info@treston.com.



The guarantee period for products manufactured by Treston is 5 years from the date of delivery; this excludes workbench tops, electronic components, custom made parts and normal wear and tear items, for which there is a guarantee period of 2 years.



Decorating with colour

Frames of workbenches, cabinets, shelving, drawer units and trolleys are all light grey RAL7035. Outside of the standard colour range, additional colours are available on request. Please contact contact a representative or email us at: sales@treston.com.

	Colour code	RAL code	Doors	Drawers	Perforated panels and back panels
Light grey	49* & 41**	RAL 7035 (ESD)	STD	A/STD	A/STD
Blue	07	RAL 5007	STD	A/STD	STD

STD = Standard factory colour, normal warehouse delivery, listed price.

A = Factory colour, delivery 15 days from the factory, listed price.

* The products ordered with the colour code 49 (RAL 7035) are entirely ESD protected. Please note the ESD protection feature of these colours will result in a slightly darker shade of colour than the given RAL code.

**The frames of the products ordered with the colour code 41 (RAL 7035) are powder coated with a light grey ESD colour, but there are non-ESD parts in these products, such as rails, rubber mats or castors.



Light grey
RAL 7035



Blue
RAL 5007



The colour code is included in those product codes that are formed with numbers.

It is either at the end, following the hyphen (e.g. 860 804-49), or in the middle (e.g. C 334-07-000).

Printed colours do not give a fully accurate representation of painted colours. Please ask a representative about various samples.



Outside of the standard colour range, additional colours are available on request.

1. Workbenches



Concept workbench, page 24

- Multiple bench variations with advanced ergonomic features
- Perfectly suitable for assembly, quality control or packing environments
- Highly adaptable to various applications and to the needs of the user
- Superior range of accessories, easily reconfigured
- Excellent stability, suitable for heavy loads up to 500 kg



500 kg



WB workbench, page 30

- Aesthetic, ergonomic and easily adaptable to a large variety of tasks and environments
- Designed for the needs of R&D, electronics assembly and testing
- Extensive range of accessories to meet any need. Various layout possibilities from back-to-back to corner solutions
- Maximum load capacity 300 kg



300 kg



TED electric desk, page 34

- TED Electric Desk comes with quick, silent and wide height adjustment
- This ergonomic sit-stand desk perfectly suits light-duty assembly work, packing applications, R&D and industrial offices
- The desk can be customized with accessories which further enhance ergonomics, free desk space and provide order
- Maximum load capacity 200 kg



200 kg



Quick Edge workstation, page 38

- The quickest height adjustment on the market - no electricity needed
- Can be customised for various operating environments
- Multiple accessories available: swivel arms for tool holders and screens, LED lights, shelves with dividers for cartons
- Maximum load capacity 100 kg



100 kg



TP workbench, page 40

- Standard and cost-effective workbench
- Suitable for a wide range of tasks and environments
- Superior range of accessories, easily reconfigured
- Steel frame with loading capacity up to 300 kg



300 kg



TPH workbench, page 46

- Standard and cost-effective workbench with one shelf
- Suitable for a wide range of tasks and environments
- Essential range of accessories for basic needs
- Steel frame with loading capacity up to 300 kg



300 kg



TPB packing bench, page 50

- Safe, economic and ergonomic all-in-one packing bench
- Adapts and grows according to needs
- 50+ accessories and add-on products available
- Steel frame with loading capacity up to 300 kg



300 kg



Workshop bench, page 52

- A sturdy, heavy-duty industrial workbench
- Very stable on uneven surfaces due to adjustable legs
- You can build your personal workstation with our wide range of accessories
- Worktop designed for very heavy loads, load capacity up to 1000 kg



1000 kg



Concept workbenches



Concept workbenches are designed for the needs of the electronics industry, where ergonomic qualities are the most important requirement. There are many possible adjustments, all components fit together seamlessly, and each detail is practical in use.

The workstation adapts to the work process and the needs of the operator. As a result all movements of the operator can be optimised, which in turn increases performance and productivity and decreases work-related stress.

Modular design provides total integration with the existing system and the potential to flexibly adapt to changes in the environment. Concept workbenches are typically used in assembly, quality control and repair work.

Concept workbenches are available in allen key, hand crank and motor adjustable versions.



- Multiple bench variations with advanced ergonomic features for quality control, packing and assembly environments
- Highly adaptable to various applications and the needs of the user
- Superior range of accessories for easy reconfiguration
- Excellent stability, suitable for heavy loads up to 500 kg

ACCESSORIES ON PAGE 57

Superior range of accessories available for ergonomic Concept workstation.



Watch this animation showcasing the versatile usage options

<https://vimeo.com/216622645>



Concept workbench examples



Concept allen key adjustable workbench

Qty	Name	Size mm	Code
1	Frame	1500 x 750	100 49 032P
1	Laminate bench top	1500 x 750	TT15075-HPL



Concept motor adjustable bench

Qty	Name	Size mm	Code
1	Frame	1500 x 750	103 49 032P
1	Laminate bench top	1500 x 750	TT15075-HPL



Concept hand crank adjustable bench

Qty	Name	Size mm	Code
1	Frame	1500 x 750	101 49 032
1	Laminate bench top	1500 x 750	TT15075-HPL



Concept ESD workstation

Qty	Name	Size mm	Code ESD
1	Motor adjustable bench frame	1500 x 750	103 49 032P
1	Bench top ESD	1500 x 750	TT15075-ESD
2	Cable duct	M750	860 044-49
1	Upright module, 1359 mm	2 x M750	903 49 001P
1	Light/balancer rail	2 x M750	918 49 006P
1	Steel shelf	M750 x 300	836 028-49
1	Perforated panel	M750 x 389	861 511-49
1	Rotating tool panel frame with a double arm	513 x 320	880 865-49
1	Perforated panel for rotating tool frame	M500	860 951-49
1	Bin rail	M750	859 151-49
7	Stacking bin ESD	105 x 165 x 75	1015-4ESD
1	LCD screen holder with a double arm		930 49 002P
1	Power rail	M750	TPR7-001
1	Treston NaturLite LED	1200	TNL1200

The Concept bench can be equipped with castors!



Castor set Ø100 ESD Code 860 429 -00

Castor set Ø100 Code 834 734 -00

Load capacity with castors 300 kg. Always adjust the bench with castors to the lowest position when the bench is moved.

Designing Concept workstation

- Select the bench frame and the height adjustment method: allen key, hand crank or motor.
- Select a bench top to suit the frame: HPL laminate, LPL laminate or ESD bench top.

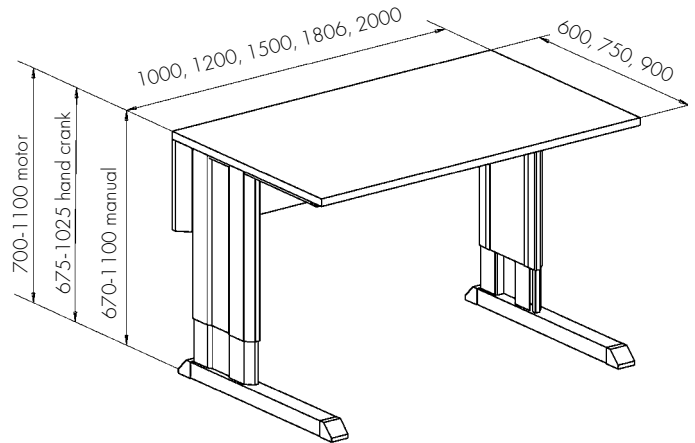

Concept workbench frame

Workbench frame size W x D mm	Bench frame, allen key adjustable Code	Bench frame max load kg	Bench frame, hand crank adjustable Code	Bench frame max load kg	Bench frame, motor adjustable Code	Bench frame max load kg
1000 x 600	100 49 015P	500	101 49 015	200	103 49 015P	400
1000 x 750	100 49 030P	500	101 49 030	200	103 49 030P	400
1000 x 900	100 49 062P	500	101 49 062	200	103 49 062P	400
1200 x 600	100 49 016P	500	101 49 016	200	103 49 016P	400
1200 x 750	100 49 031P	500	101 49 031	200	103 49 031P	400
1200 x 900	100 49 063P	500	101 49 063	200	103 49 063P	400
1500 x 600	100 49 017P	500	101 49 017	200	103 49 017P	400
1500 x 750	100 49 032P	500	101 49 032	200	103 49 032P	400
1500 x 900	100 49 064P	500	101 49 064	200	103 49 064P	400
1800 x 600	100 49 018P	500	101 49 018	200	103 49 018P	400
1800 x 750	100 49 033P	500	101 49 033	200	103 49 033P	400
1800 x 900	100 49 065P	500	101 49 065	200	103 49 065P	400
2000 x 600	100 49 019P	500			103 49 019P	400
2000 x 750	100 49 034P	500			103 49 034P	400
2000 x 900	100 49 066P	500			103 49 066P	400
Bench height steplessly adjustable	670 - 1100 mm		675 - 1025 mm		700 - 1100 mm Height adjustment speed 13 mm / second	

Concept bench tops

Size W x D mm	Code HPL	Code LPL	Code ESD
1000 x 600	TT10060-HPL	TT10060-LPL	TT10060-ESD
1000 x 750	TT10075-HPL	TT10075-LPL	TT10075-ESD
1000 x 900	TT10090-HPL	TT10090-LPL	TT10090-ESD
1200 x 600	TT12060-HPL	TT12060-LPL	TT12060-ESD
1200 x 750	TT12075-HPL	TT12075-LPL	TT12075-ESD
1230 x 750	TT12375-HPL	TT12375-LPL	TT12375-ESD
1200 x 900	TT12090-HPL	TT12090-LPL	TT12090-ESD
1230 x 900	TT12390-HPL	TT12390-LPL	TT12390-ESD
1500 x 600	TT15060-HPL	TT15060-LPL	TT15060-ESD
1500 x 750	TT15075-HPL	TT15075-LPL	TT15075-ESD
1530 x 750	TT15375-HPL	TT15375-LPL	TT15375-ESD
1500 x 900	TT15090-HPL	TT15090-LPL	TT15090-ESD
1530 x 900	TT15390-HPL	TT15390-LPL	TT15390-ESD
1806 x 600	TT18060-HPL	TT18060-LPL	TT18060-ESD
1806 x 750	TT18075-HPL	TT18075-LPL	TT18075-ESD
1836 x 750	TT18375-HPL	TT18375-LPL	TT18375-ESD
1806 x 900	TT18090-HPL	TT18090-LPL	TT18090-ESD
1836 x 900	TT18390-HPL	TT18390-LPL	TT18390-ESD
2000 x 600	TT20060-HPL	TT20060-LPL	TT20060-ESD
2000 x 750	TT20075-HPL	TT20075-LPL	TT20075-ESD
2000 x 900	TT20090-HPL	TT20090-LPL	TT20090-ESD

Laminate bench top -HPL

- Light grey high pressure laminate
- Plastic edging
- Thickness 25 mm

Laminate bench top -LPL

- Light grey low pressure laminate
- Plastic edging
- Thickness 25 mm

ESD bench top

- Light grey laminate surface
- Grey edging
- Thickness 25 mm
- Semi-conductive (ESD)

Concept extension benches

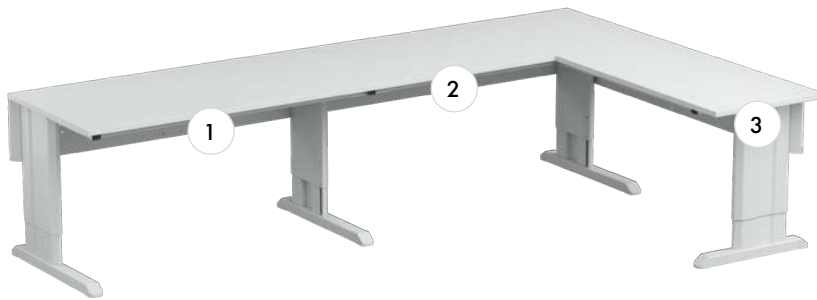

- 1. Workbench frame,
- 2. Extension bench frame
- 3. Corner bench frame

Concept extension bench frame (right)

Name	Size W x D mm	Max load kg	Code
Extension bench frame	1500 x 600	250	112 49 001P
Extension bench frame	1500 x 750	250	112 49 002P
Extension bench frame	1800 x 750	250	112 49 003P
Extension bench frame	1500 x 900	250	112 49 007P
Extension bench frame	1800 x 900	250	112 49 008P

Concept corner bench frame (right)

Name	Size W x D mm	Max load kg	Code
Corner bench frame for allen key adjustable bench 600 mm deep	1000 x 600	250	111 49 001P
Corner bench frame for allen key adjustable bench 750 mm deep	1200 x 600	250	111 49 002P

Concept extension bench frame (left)

Name	Size W x D mm	Max load kg	Code
Extension bench frame	1500 x 600	250	112 49 004P
Extension bench frame	1500 x 750	250	112 49 005P
Extension bench frame	1800 x 750	250	112 49 006P
Extension bench frame	1500 x 900	250	112 49 009P
Extension bench frame	1800 x 900	250	112 49 010P

Concept corner bench frame (left)

Name	Size W x D mm	Max load kg	Code
Corner bench frame for allen key adjustable bench 600 mm deep	1000 x 600	250	111 49 003P
Corner bench frame for allen key adjustable bench 750 mm deep	1200 x 600	250	111 49 004P

Transport skate

With a transport skate, one person can easily move benches. For long-distance moving, you will need two transport skates.

Name	Max load kg	Code	Code ESD
Transport skate	180	854 061-41	854 061-49

Compatible with tables with a max depth of 750 mm.



Battery set for Concept motor adjustable frames and TED electric desks

The smaller sized Concept and TED workbenches equipped with castors, electric height adjustment, and battery set are an excellent option for workspaces where you need a compact size, easily height adjustable, and mobile work surface. You get all the ergonomic benefits of easy, electric height adjustment, and freedom of mobility with the battery set – no need to worry if the power cables are long enough for moving the work surface around the workspace.

Name	Code
Battery set	BSC001

Suitable for Concept motor adjustable frames and TED electric desks. Battery set sold only to EU countries.



Concept upright tubes

Accessories are attached to the Concept bench with the aid of upright tubes or a complete, upright tube module.

The module includes upright tubes, horizontal tube/tubes, corner bracket pair and straight bracket (if module has more than one horizontal tube). The tubes or the module are attached to the back of the bench.

Upright tubes

Name	Size W x D mm	Length (l) mm	Code
Upright tube	30 x 60	500	860 991-49
Upright tube	30 x 60	800	860 142-49
Upright tube	30 x 60	996	860 367-49
Upright tube	30 x 60	1359	860 024-49
Upright tube	30 x 60	1582	860 025-49
Horizontal tube	M500		860 819-49
Horizontal tube	M750		847 402-49
Horizontal tube	M900		840 104-49
Horizontal tube	M1000		854 656-49
Horizontal tube	M1200		854 655-49
Horizontal tube	M1350		850 914-49
Horizontal tube	M1500		854 654-49
Horizontal tube	M1800		854 657-49
Corner bracket pair			848 336-49
Straight bracket			851 827-49



Upright tube modules and compatibility

	Suitable for bench widths C = Concept					Code l=1359 mm h=1075 mm	Code l=1582 mm h=1300 mm
	1000	1200	1500	1800	2000		
1 x M750	C	C	C	C	C	900 49 001P	900 49 002P
1 x M900	C	C	C	C	C	901 49 001P	901 49 002P
2 x M500	C	C				902 49 001P	902 49 002P
2 x M750			C	C	C	903 49 001P	903 49 002P
2 x M900				C	C	904 49 001P	904 49 002P
3 x M500			C	C		905 49 001P	905 49 002P
4 x M500					C	906 49 001P	906 49 002P

h = module's height measured from Concept bench's top surface.

Load capacity 100 kg / module spacing.

Upright tube modules are available also with 996 mm uprights (h=714 mm).
Item codes: 90X 49 003P.

Upright tube modules include 5 pcs of cable clips for easy cable management.

Aluminium bracket

Name	Code
Aluminium bracket	846 554-00

A separate aluminium bracket (846 554-00) can be used to attach a single tube to any bench.

CC cable clip set CC5

Name	Suitable for	Code
Cable clip set (5 pcs)	Upright tubes	CC5

For easy cable management, suitable for up to five cables.

The modular (M) size refers to the distance between two upright tubes from the middle of the tube. The modular size is used to find the appropriate accessories.

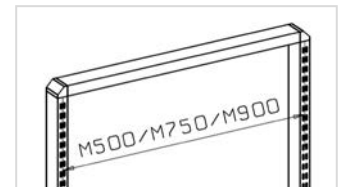

The upright tubes can also be used separately without the horizontal tubes. In this case, please order the end cap 900370-00 for the upright tubes (1 pcs per upright tube).



Accessories from page 57

Superior range of accessories available for ergonomic Concept workstation.



Aluminium bracket



CC cable clip set

Concept also accommodates the most demanding packaging needs!

Whatever the packaging need, you can build it from Concept and its modular elements.

Modules fit together seamlessly, giving you an opportunity to create a complete packaging solution, perfectly matching your needs. Building packaging combinations from varying, yet standard modules makes it possible to create an ergonomically well-functioning packaging solution which is also robust and economic. No need for costly extra modifications or compromises!



READ MORE ABOUT
Treston packing benches
from our separate brochure.



treston.com/catalogues-and-brochures



Largest number of accessories on the market.



WB workbenches



The WB workbench has been designed for use in demanding assembly environments. Besides offering modularity and great ergonomics, the bench is aesthetically pleasing.

Electric motor, manual hand crank or allen key height adjustment cater for standing or seated users, while the generous worktop depth and broad accessory range ensure that everything is within easy reach. Another feature of this new design is the flush bench footprint; benches can be placed side-by-side, back-to-back, or right up against walls with no unnecessary gaps. You can design your workstation to fit your needs perfectly.

Worktop height can be adjusted between 700-1100 mm. The adjustment system in both cases utilises interlocking aluminium profiles, providing a strong, rigid frame. Steel frame parts are epoxy powder coated light grey paint. Worktops are of 25 mm laminated particle board, adjustable feet are provided for fine levelling.



- Designed for the needs of R&D, electronics assembly and testing
- Ergonomic and easily adaptable to a large variety of tasks and environments
- Extensive range of accessories to meet any need
- Various layout possibilities from back-to-back to corner solutions

ACCESSORIES ON PAGE 74

Extensive range of accessories available for ergonomic WB workstation.



Watch this animation showcasing the versatile usage options

<https://vimeo.com/219470050>



WB workbench examples



WB mobile industrial office workstation

Qty	Name	Code
1	WB electric adjustable bench 1100	WB811 EL
1	Castor set	LCS100
1	Upright profile	AL2X110W
1	LCD bracket	MH
1	Bin profile	BP100
1	Auxiliary steel shelf A5	ASSA5
2	Treston NaturLite Led Wing 500	TNL500W
1	Light steel cabinet	LMC01
1	Cover	LMCK2
1	Bottle holder	CH



WB packing workstation

Qty	Name	Code
1	WB electric adjustable bench 1500	WB815 EL
1	WB side worktop	WB804ST
1	Upright profile	AL2X150W
1	Support bracket	HSB150
1	Treston NaturLite Led 1200	TNL1200
1	Shelf ALH	ALH150
1	Divider hoops	PDH
1	Recycling material bin	PRMB
1	Power rail 331, 3 sockets + 2 x USB	TPR3-001
1	Lower shelf AT	AT150 WB
1	Light steel cabinet	LMC01
1	Cover	LMCK2



WB assembly workstation

Qty	Name	Code
1	WB electric adjustable bench 1800	WB818 EL
1	WB side worktop	WB804 ST
1	Upright profile	AL2X180W
1	Accessory frame AKK	AKK180
1	Support bracket	HSB180
1	Treston NaturLite Led 1200	TNL1200
1	Shelf ALH	ALH180
1	Power rail 683, 5 sockets + switch + 2 x USB	TPR7-001
1	Adjustable shelf ASH	ASH70
1	Light steel cabinet	LMC02
1	Cover	LMCK2
1	LCD swivel arm	MA
1	Swivel arm with tray	AKV400
2	Bin profile	BP100
1	Auxiliary steel shelf A4	ASSA4



WB ESD workstation

Qty	Name	Code ESD
1	WB electric adjustable bench 1800	WB818 EL ESD
1	Earthing box ESD	J6603
1	Upright profile	AL2X180W
1	Support bracket	HSB180
1	Treston NaturLite Led 1200	TNL1200
1	Shelf ALH ESD	ALH180 ESD
1	Accessory frame AKK ESD	AKK180
1	Perforated panel ESD	ARL70
2	Bin profile ESD	BP100 ESD
2	Auxiliary steel shelf A5	ASSA5
1	Swivel arm with tray ESD	AKV400 ESD
1	LCD swivel arm	MA
1	Light steel cabinet ESD	LMC02 ESD
1	Cover	LMCK2
1	Magnifying lamp Wave LED ESD	TWL ESD

Designing WB workbench

- Select the height adjustment method: allen key, electric or crank.
- Select a bench top to suit the frame: laminate or ESD bench top.

WB allen key adjustable bench

Bench size W x D mm	Max load kg	Code	Code ESD
1073 x 800	300	WB811	WB811 ESD
1500 x 800	300	WB815	WB815 ESD
1800 x 800	300	WB818	WB818 ESD

We recommend using cable tidy WBCT with WB allen key adjustable benches.

WB electric adjustable bench

Bench size W x D mm	Max load kg	Code	Code ESD
1073 x 800	300	WB811 EL	WB811 EL ESD
1500 x 800	300	WB815 EL	WB 815 EL ESD
1800 x 800	300	WB818 EL	WB818 EL ESD

Height adjustment speed 20 mm/ second.

Cable tidy as standard.

WB crank adjustable bench

Bench size W x D mm	Max load kg	Code	Code ESD
1073 x 800	200	WB811 C	WB811 C ESD
1500 x 800	200	WB815 C	WB815 C ESD
1800 x 800	200	WB818 C	WB818 C ESD

Cable tidy as standard.



WB electric adjustable bench has a desk panel with memory function



Laminate bench top

- 25 mm low pressure laminate
- Light grey surface
- Plastic edging



ESD bench top

- Light grey laminate surface
- Grey edging
- Thickness 25 mm
- Semi-conductive (ESD)

The WB bench can be equipped with castors!



Castor set Ø100 ESD Code LCS100 ESD
 Castor set Ø100 Code LCS100

Load capacity with castors is the same as the bench loading capacity with adjustable screws. We recommend using the cable tidy WBCT with WB Allen-key adjustable benches. Always adjust the bench with castors to the lowest position when the bench is moved.

WB extension benches



+ **Accessories from page 74**
Extensive range of accessories available for ergonomic WB workstation..



1. WB side worktop

This side worktop can be installed on either the right or left hand side of a WB bench to increase the surface area. Installation can be either at the same height, or lower than the main worktop with the brackets provided. Load capacity is 40 kg, and it is suitable for all WB models in the range.

Size W x D mm	Max load kg	Code	Code ESD
400 x 800	40	WB804 ST	WB804 ST ESD

2. WB corner worktop

A corner worktop can be used with two WB benches to create a 90° angle setup. This unit consists of a worktop and all necessary components. It requires no additional leg frames, simply mounting to the standard benches with the brackets provided. Load capacity for this worktop is 80 kg. Doesn't suit crank adjustable bench. Suitable for WB EL to order.

Size W x D mm	Max load kg	Code	Code ESD
1154 x 1154	80	WB1212 CT	WB1212 CT ESD

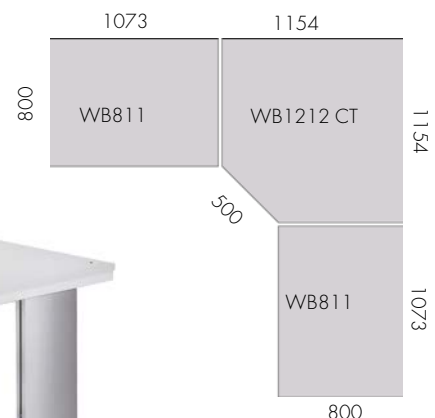

Electric Desk TED for industrial use



Treston Electric Desk TED adjusts to different heights quickly and silently, extending from as low as 630 mm all the way up to 1270 mm. Accommodating a wide range of heights serves especially well in light-duty assembly work and packing applications, where the handled items can vary from big to small. A desk with a quick and wide adjustment range helps keep employees working comfortably and ergonomically in all situations.

The desk serves also in R&D laboratories as well as industrial offices well, as it withstands loads of 200 kg, and the desk can be customized with a range of accessories. The above- and below-desk accessories further enhance ergonomics, free desk space and provide order.



- Quick, silent and wide height adjustment 630-1270 mm (range 64 cm)
- This ergonomic sit-stand desk perfectly suits light-duty assembly work, packing applications, R&D and industrial offices.

ACCESSORIES ON PAGE 57

Comprehensive range of accessories available for ergonomic TED workstation



Watch the 2 min animation showcasing the features
<https://vimeo.com/513555408>



TED desk examples



TED industrial office desk

Qty	Name	Size mm	Code
1	Treston Electric Desk	1500 x 800	TED815-41
1	Upright Tube Pair with a flange	400	TTP400-49
2	Treston Display Bracket for light duty		TDB-49
1	Drawer unit ESD 30/22		859 340-49
1	Drawer unit 30 fastening set for TED		855 057-49
1	Bottle holder ESD for upright tube	Ø100	859 063-49



TED industrial office desk

Qty	Name	Size mm	Code
1	Treston Electric Desk	1100 x 800	TED811-41
1	Upright Tube Pair with a flange	790	TTP790-49
1	Perforated back panel	M900	861 516-49
1	LCD monitor holder for perforated panel		890 715-49
2	Treston NaturLite Led Wing 500		TNL500W
2	Auxiliary steel shelf for perforated panel	159 x 210	ASSA5PP
1	Bottle holder ESD for upright tube	Ø100	859 063-49
1	Laptop/printer shelf ESD	365 x 365	930 49 001P
1	Cable clip set for upright tubes		CC5
1	Power rail	836	TPR9-010



TED ESD workstation

Qty	Name	Size mm	Code ESD
1	Treston Electric Desk ESD	1500 x 800	TED815-49
1	Upright Tube Pair with a flange	790	TTP790-49
1	Light and balancer rail ESD		918 49 011P
1	Treston IntoLite Led	850	TIL850
1	Perforated back panel	M1350	861 521-49
1	Treston Display Bracket for light duty		TDB-49
1	Curved bin rail ESD with arm	770 x 54	929 49 002P
1	Steel shelf ESD M1350	1340 x 300	860 787-49
1	Aluminium bin rail M1350		BP1350C
2	Auxiliary steel shelf	159 x 210	ASSA5
1	Magnifying lamp Wave LED ESD		TWL ESD
1	Drawer unit ESD 30/15		859 330-49
1	Drawer unit 30 fastening set for TED		855 057-49
1	Power rail	836	TPR9-010



TED packing station

Qty	Name	Size mm	Code
1	Treston Electric Desk	1800 x 800	TED818-41
1	Upright Tube Pair with a flange	790	TTP790-49
1	Paper roll holder set for upright tube		859 041-49P
1	Pair of paper roll dividers		RD25
1	Cutter	1350	PPC135
1	Steel shelf ESD M1500	1490 x 300	890 756-49
3	Divider pair	285 x 190	010 004-49
1	Light and balancer rail ESD		918 49 006P
1	Treston NaturLite LED	1180	TNL1200
1	Rotating tool frame ESD, double arm	513 x 320	880 865-49P
1	Perforated panel ESD	470 x 300	860 951-49
1	Recycling material bin		PRMB
1	Tool holder box		PPH TXL

Designing TED desk

- TED desk consists of the frame and the bench top.
- Equip with accessories. To equip TED with above-desk accessories, select first the upright tube pair.

TED Electric Desk

Size W x D mm	Module	Max load kg	Code	Code ESD
900 x 800	M750	200	TED809-41	TED809-49
1100 x 800	M900	200	TED811-41	TED811-49
1500 x 800	M1350	200	TED815-41	TED815-49
1800 x 800	M1500	200	TED818-41	TED818-49

Height adjustment speed 22 mm / second





Laminate bench top

- 25 mm low pressure laminate
- Light grey surface
- Plastic edging

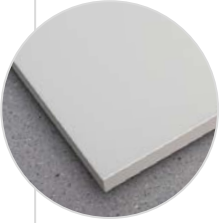

ESD bench top

- Light grey laminate surface
- Grey edging
- Thickness 25 mm
- Semi-conductive (ESD)



Upright Tube Pair with a flange

Treston upright tubes enable TED electric desk to be accessorised in many ways. Fitted on worktop with screws.

Size W x D x H mm	Code ESD
70 x 100 x 418	TTP400-49
70 x 100 x 793	TTP790-49
70 x 100 x 997	TTP990-49



Upright Tube Pair with a flange

+

Accessories from page 57

Wide range of accessories available for Treston Electric Desk TED.

Lower shelf for TED desk

400 mm deep lower shelf for many purposes. Includes back lip. Fitted under worktop with screws. The lower shelf can also be equipped with divider hoops.

Size W x D mm	Suitable for	Max load kg	Code
465 x 400	All TED benches	60	LST500-49
715 x 400	TED811, TED,815, TED818	60	LST750-49
865 x 400	TED815, TED818	60	LST900-49
965 x 400	TED815, TED818	60	LST1000-49
1165 x 400	TED818	60	LST1200-49
1315 x 400	TED818	60	LST1350-49
Divider hoops set (4 pcs) 400 x 400			PDH400-49



Battery set for Concept motor adjustable frames and TED electric desks

The smaller sized Concept and TED workbenches equipped with castors, electric height adjustment, and battery set are an excellent option for workspaces where you need a compact size, easily height adjustable, and mobile work surface. You get all the ergonomic benefits of easy, electric height adjustment, and freedom of mobility with the battery set – no need to worry if the power cables are long enough for moving the work surface around the workspace.

Battery set

Name	Code
Battery set	BSC001
Suitable for Concept motor adjustable frames and TED electric desks. Battery set sold only to EU countries.	



The TED desk can be equipped with castors!

Castor set Ø100 ESD Code LCS100 ESD
 Castor set Ø100 Code LCS100

Always adjust the bench with castors to the lowest position when the bench is moved.

Treston Quick Edge workstation



The easier the workstation's height adjustment gets, the more likely you will adjust it. Meet the industrial workstation with the quickest height adjustment on the market. Workstation height is adjusted with a completely new, innovative, and user-friendly mechanism. The patent pending height adjustment solution minimises the height exchange time between handled items and makes daily work more fluent, efficient, and ergonomic.

This industrial workstation is designed, for example, for packing and logistic centres, where the desk height adjustment is done according to the differently sized cartons. The Treston Quick Edge Workstation adapts for operators of different standing heights and increases both performance and ergonomics.



- Extremely wide height adjustment range 570–1300 mm
- Patent pending solution: Adjust the optimal height effortlessly for every task / produced item

ACCESSORIES ON PAGE 57

Comprehensive range of accessories available for Treston Quick Edge workstation



Watch the 2 min video showcasing the features
<https://vimeo.com/679903135>



Designing Quick Edge workstation

- Quick Edge workstation consists of the frame, the bench top and upright profiles.
- Equip with M1200 wide accessories, swivel arms or printer platforms.
- Quick Edge workstation can be used in EPAs with grounding set TQE-ESD.

Quick Edge workstation

Size W x D mm	Module	Max load kg	Code
1200 x 700	M1200	100*	TQEW712-41

Static load capacity for bench top 100 kg, total load capacity for frame 300 kg.



The new, innovative, patent pending height adjustment solution minimises the height exchange time between handled items and makes daily work more fluent, efficient, and ergonomic. Bench top is adjusted without load due to the constant force springs as an adjustment mechanism.

Grounding set for Treston Quick Edge workstation

Name	Code
Grounding set for Treston Quick Edge workstation	TQE-ESD

With this grounding set you can use Treston Quick Edge workstation in EPAs.



Grounding set for Treston Quick Edge workstation

Spring set for Treston Quick Edge Workstation

Name	Code
Spring set for Treston Quick Edge Workstation	TQES

Replace the constant force spring set at least after every 10 000 operating cycles.



Quick Edge workstation can be equipped with castors.

Castor set Ø100 Code LCS100

Castor set ESD Ø 100 Code LCS100 ESD

TP workbenches



The classically designed TP workbench is the ideal basic bench, the simplest and the most cost-effective option in our range of workbenches. TP workbenches are standard benches that are suitable for a broad range of tasks and environments when fitted with accessories: testing, packing, repairing, inspecting. TP bench is guaranteed for regular use with loads up to 300 kg.

This modular system enables high quality working environment. Customise your workstation to your own requirements.

Stepless height adjustment

The height of workbenches in our TP range can be steplessly adjusted from 650 to 900 mm, which makes these benches suitable for work while sitting or standing. Packing is a typical example of work where the workbench height must be set correctly for the height of the user.



- Standard and cost-effective workbench
- Suitable for a wide range of tasks and environments
- Superior range of accessories, easily reconfigured
- Steel frame with loading capacity up to 300 kg

ACCESSORIES ON PAGE 57

Superior range of accessories available for ergonomic TP workstation



Watch this animation showcasing the versatile usage options

<https://vimeo.com/219469789>



TP workbench examples



TP workstation

Qty	Name	Size mm	Code
1	TP workbench	1200 x 700	TP712
1	Accessory frame	1200	TPK12-49
2	Upright tube	1359	860 024-49
1	Horizontal tube	M1200	854 655-49
1	Corner bracket pair		848 336-49
1	Tilttable top shelf	M1200 x 300	TTSM12003-49
1	Light and balancer rail	M1200	918 49 010P
1	Treston IntoLite Led	850	TIL850



TP packing workstation

Qty	Name	Size mm	Code
1	TP workbench	1800 x 700	TP718
1	Accessory frame	1800	TPK18-49
1	Upright tube module	2 x M900/1582	904 49 002P
1	Light/balancer rail	2 x M900/1800	918 49 008P
1	Treston NaturLite	1200	TNL1200
1	LCD screen holder		930 49 002P
1	Equipment tray	500 x 250 x 125	928 49 002P
1	Perforated back panel	M900 x 389	861 516-49
1	Recycling material bin	530 x 280 x 585	PRMB
1	Roll holder set	M900	890 548-49P
1	Tilttable top shelf	M900 x 300	TTSM9003-49
1	Divider hoops set	300 x 400	PDH300-49
1	Aluminium bin rail	M900	BP900C
2	Auxiliary steel shelf	159 x 254 x 50	ASSA5
1	Auxiliary steel shelf	217 x 298 x 20	ASSA4
1	Pull-out steel shelf for printer	500 x 510 x 515	PSP50
1	Shelf for packing material	M900 x 600	SPM900-49
1	Adjustable fastening set under worktop		SPMAF-49
1	Divider hoops set SPM-shelf	400 x 280	PDH600
1	Power rail		TPR9-001

See options for rotating tool panel with perforated panel and other accessories on page 62.



TP repair workstation

Qty	Name	Size mm	Code
1	TP workbench	1500 x 700	TP715
1	Accessory frame	1500	TPK15-49
1	Upright tube module	2 x M750/1582	903 49 002P
1	Light/balancer rail	2 x M750/1500	918 49 006P
1	Treston NaturLite	1200	TNL1200
1	Tilttable top shelf	M750 x 300	TTSM7503-49
2	Accessory box	220 x 300	ABTTS3-41
1	Lower shelf	1380 x 500	AT 150TPH
1	Perforated back panel	M750 x 1003	861 514-07
2	Aluminium bin rail	M750	BP750C
8	Stacking bin	149 x 192 x 105	1520-5/6
1	Perforated tool cabinet	M750 x 255 x 900	852 629-07
1	Drawer unit 45/14-1	450 x 520 x 140	603 49 001
1	Power rail	468	TPR4-001

**The TP bench
can be equipped
with castors!**



Castor set Ø100, code 834 734 -00
Castor set Ø100 ESD, code 860 429 -00
Insert set (required to fit castors), code 853 289-00

Load capacity with castors 150 kg. We recommend using the accessory frame with the castors. Always adjust the bench with castors to the lowest position when the bench is moved.

Designing TP workstation

- Select laminate or ESD version of the bench
- Equip with accessories. To equip TP with above-desk accessories, select first the upright tubes.



TP workbench

Bench size W x D mm	Max load kg	Code	Code ESD
700 x 500	150	TP507	TP507 ESD
1000 x 500	150	TP510	TP510 ESD
1500 x 500	150	TP515	TP515 ESD
1000 x 700	300	TP710	TP710 ESD
1200 x 700	300	TP712	TP712 ESD
1500 x 700	300	TP715	TP715 ESD
1800 x 700	300	TP718	TP718 ESD
1500 x 900	300	TP915	TP915 ESD
1800 x 900	300	TP918	TP918 ESD



Laminate bench top

- 25 mm low pressure laminate
- Light grey surface
- Plastic edging

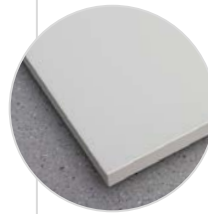

ESD bench top

- Light grey laminate surface
- Grey edging
- Thickness 25 mm
- Semi-conductive (ESD)

1. Lower shelf for TP

Name	Size W x D mm	Max load kg	Code
Lower shelf	1080 x 500	50	AT 120TPH
Lower shelf	1380 x 500	50	AT 150TPH
Lower shelf	1680 x 500	50	AT 180TPH

Not enough space above the workstation? Then utilise the space below. The lower shelf for TP bench simply hangs on the horizontal bars.



2. Lower steel shelf LSS

Name	Size W x D mm	Max load kg	Code
Lower shelf	1418 x 460	30	LSS150
Lower shelf	1718 x 460	30	LSS180
Low M-divider hoops (4 pcs/set)	460 x 315		LDH

Hangs on the horizontal bars. Can be equipped with steplessly adjustable low M-divider hoops.



3. Side worktop

Name	Size W x D mm	Max load kg	Code
Side worktop	400 x 700	35	TP704 ST
Side worktop	400 x 900	35	TP904 ST

Easy to fix to the legs of the bench. Can be fixed on the left or right side of the bench and brackets placed either above or underneath. Height adjustable 575-900 mm from the floor.



TP extension benches

Line extension TP-L

Each standard TP bench may also be supplied as a line extension. Fitted to the side of the main bench.

Bench size W x D mm	Max load kg	Code	Code ESD
1000 x 700	150	TP710 L	TP710 L ESD
1200 x 700	150	TP712 L	TP712 L ESD
1500 x 700	150	TP715 L	TP715 L ESD
1800 x 700	150	TP718 L	TP718 L ESD
1500 x 900	150	TP915 L	TP915 L ESD
1800 x 900	150	TP918 L	TP918 L ESD



Angle extension TP-K

Each standard TP bench may also be supplied as an angle extension. Fitted to front angle of main bench.

Bench size W x D mm	Max load kg	Code	Code ESD
1000 x 500	150	TP510 K	TP510 K ESD
1200 x 700	150	TP712 K	TP712 K ESD



Corner workbench TP-KK

A corner workbench can be used with two TP benches (with one H-frame pair) to create a 90 ° angle setup. TP KK unit consists of a worktop, two H-frames and a leg in the middle. Front side 565 mm.

Bench size W x D mm	Max load kg	Code	Code ESD
1100 x 1100	150	TP707 KK	TP707 KK ESD
1300 x 1300	150	TP909 KK	TP909 KK ESD



* Workbench with one H-frame pair.

SAP trolley

TP bench style construction. Height adjustment with allen key between 650-900 mm. Swivel castors (Ø 100 mm), two of which have brakes. Load capacity 150 kg. Lower shelf, extra shelf and push handle available separately.

Name	Size W x D mm	Max load kg	Code	Code ESD
Trolley	700 x 500	150	SAP507	SAP507 ESD
Trolley	1000 x 700	150	SAP710	SAP710 ESD
Lower shelf	700 x 500	40	AT507	AT507 ESD
Lower shelf	1000 x 700	40	AT710	AT710 ESD
Extra shelf	700 x 500	40	LT507	LT507 ESD
Extra shelf	1000 x 700	40	LT710	LT710 ESD
Handle	depth 500		PUSH50	PUSH50
Handle	depth 700		PUSH70	PUSH70



SAP trolley with AT lower shelf, LT extra shelf and PUSH handle

TP upright tubes

Accessories are attached to the TP bench with the aid of upright tubes or a complete, upright tube module.

The module includes upright tubes, horizontal tube/tubes, corner bracket pair and straight bracket (if module has more than one horizontal tube). The upright tubes or the upright tube module are attached to the back of the TP bench with accessory frame (ordered separately). When using three upright tubes with the bench, we recommend using the complete upright tube modules.



Accessories from page 57

Superior range of accessories available for ergonomic TP workstation.

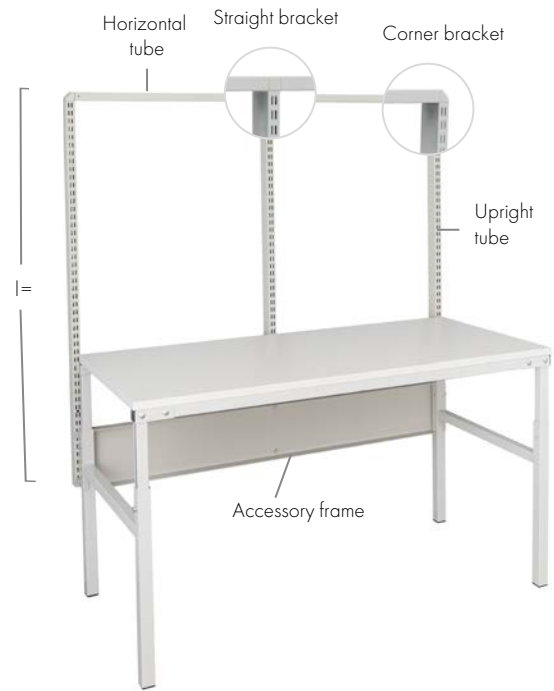

Accessory frame

Bench frame width mm	Fixing points for uprights	Code
1000	1 x M900, 1 x M1000	TPK10-49
1200	1 x M750, 1 x M900, 1 x M1200	TPK12-49
1500	1 x M1500, 2 x M750	TPK15-49
1800	1 x M1800, 2 x M900	TPK18-49

Upright tubes or the upright tube module are always attached to TP bench with accessory frame. The accessory frame cannot be used on line or corner extensions.



Accessory frame

Upright tubes

Name	Size W x D mm	Length (l) mm	Code
Upright tube	30 x 60	500	860 991-49
Upright tube	30 x 60	800	860 142-49
Upright tube	30 x 60	996	860 367-49
Upright tube	30 x 60	1359	860 024-49
Upright tube	30 x 60	1582	860 025-49
Horizontal tube	M500		860 819-49
Horizontal tube	M750		847 402-49
Horizontal tube	M900		840 104-49
Horizontal tube	M1000		854 656-49
Horizontal tube	M1200		854 655-49
Horizontal tube	M1350		850 914-49
Horizontal tube	M1500		854 654-49
Horizontal tube	M1800		854 657-49
Corner bracket pair			848 336-49
Straight bracket			851 827-49

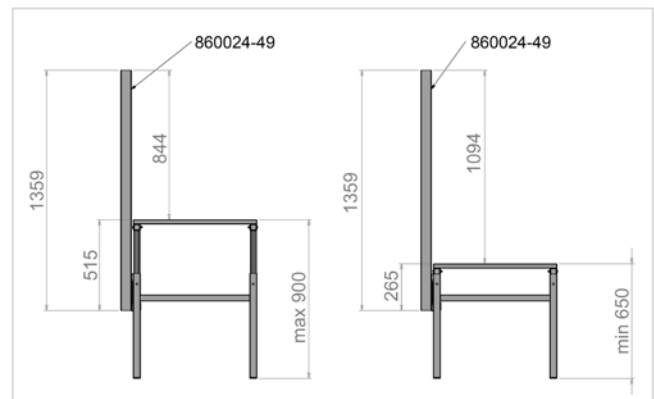

Usable height of the upright tube

Aluminium bracket

Name	Code
Aluminium bracket	846 554-00

Bracket can be used to attached a single tube to the bench.



Upright tube with aluminium bracket attached to the bench

Upright tube modules and compatibility

Suitable for bench widths TP = TP workbench				Code	Code
1000 1200 1500 1800 2000				l=1359 mm	l=1582 mm
1 x M750	TP			900 49 001P	900 49 002P
1 x M900	TP	TP		901 49 001P	901 49 002P
2 x M500				902 49 001P	902 49 002P
2 x M750		TP		903 49 001P	903 49 002P
2 x M900			TP	904 49 001P	904 49 002P
3 x M500				905 49 001P	905 49 002P
4 x M500				906 49 001P	906 49 002P

Load capacity 100 kg / module spacing. Upright tube modules include 5 pcs of cable clips for easy cable management.



The upright tubes or the upright tube module are attached to the back of the TP bench with accessory frame

TP upright frame with bench top

TP upright frame with bench top is a lighter version of the TP workbench. In addition to the bench top attached to the frame, it can be equipped with any of the Concept accessories. It is ideal for lighter use, when some additional workspace is needed.

TP upright frame

Size W x H mm	Max load kg	Code
M750 x 1500	300	123 49 005
M750 x 1850	300	123 49 006
M900 x 1500	300	123 49 007
M900 x 1850	300	123 49 008

Bench top & brackets for TP upright frame

Size W x D mm	Max load kg	Code HPL	Code LPL	Code ESD
1200 x 600	60	TT12060-HPL	TT12060-LPL	TT12060-ESD
Corner bracket pair	860	139-49		

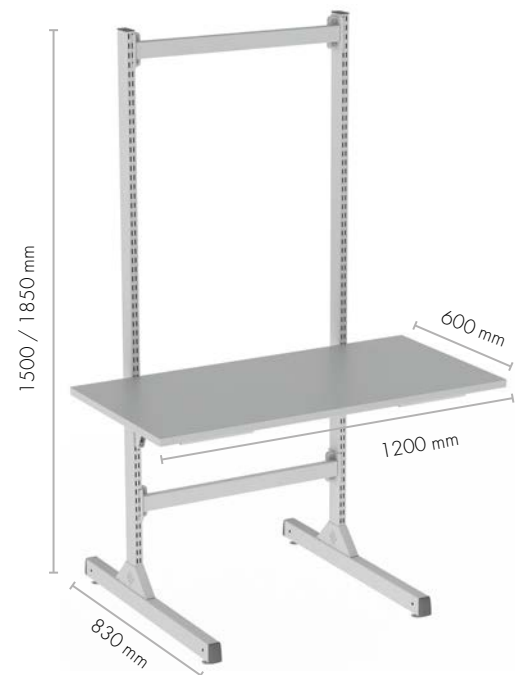

Laminate bench top -HPL

- Light grey high pressure laminate
- Plastic edging
- Thickness 25 mm

Laminate bench top -LPL

- Light grey low pressure laminate
- Plastic edging
- Thickness 25 mm

ESD bench top

- Light grey laminate surface
- Grey edging
- Thickness 25 mm
- Semi-conductive (ESD)

TPH workbenches



The TPH workbench includes a pair of uprights and one shelf; composing one of our best selling workstations.

It has its own range of accessories, also in stock, and covering the essential, basic needs of any professional workstation.

Stepless height adjustment

The height of TPH workbenches can be steplessly adjusted with allen-key from 650 to 900 mm, which makes these benches suitable for work while sitting or standing. The height adjustment of the laminate shelf is between 1080-1550 mm. Load capacity for the bench top is 300 kg and for the shelf 50 kg even load.



- Standard and cost-effective workbench with one shelf
- Suitable for a wide range of tasks and environments
- Essential range of accessories for basic needs
- Steel frame with loading capacity up to 300 kg

ACCESSORIES ON PAGE 79

Essential range of accessories available for ergonomic TPH workstation.

TPH workbench examples



TPH workbench

Qty	Name	Size mm	Code
1	TPH workbench	1500 x 700	TPH715
1	Lower steel shelf	1418 x 460	LSS150
1	Divider hoop set	460 x 315	LDH



TPH workstation

Qty	Name	Size mm	Code
1	TPH workbench	1200 x 700	TPH712
1	Tool and lighting support	1200 x 600	KT120
1	Treston IntoLite Led	850	TIL850
1	Perforated panel	1115 x 750	RL120
1	Connector set		RK1



TPH workstation

Qty	Name	Size mm	Code
1	TPH workbench	1800 x 700	TPH718
1	Tool and lighting support	1800 x 600	KT180
1	Treston IntoLite Led	850	TIL850
2	Aluminium bin profile	1705	BP180
1	Metal shelf	1719 x 145	TH180
1	Tool holder box	400 x 300 x 150	PPH TXL
3	Auxiliary steel shelf	217 x 298 x 20	ASSA4
6	Stacking bin	149 x 192 x 105	1520-5
6	Stacking bin	149 x 250 x 130	1525-5
8	Stacking bin	105 x 165 x 75	1015-5
1	Power rail	1700	TPR17-001
1	Side worktop	400 x 700	TP704ST



TPH ESD workstation

Qty	Name	Size mm	Code ESD
1	TPH workbench ESD	1800 x 700	TPH718 ESD
1	Tool and lighting support	1800 x 600	KT180
1	Treston NaturLite Led	1200	TNL1200
1	Perforated panel	1715 x 750	RL180
1	Connector set		RK1
3	Auxiliary steel shelf for perforated panel	159 x 243 x 56	ASSA5PP
2	Hook R46		839 086-51
1	Hook R42		838357-51
3	Stacking bin		1525-4ESD
1	LCD monitor holder for perforated panel		890 715-49
2	Swivel arm with tray ESD	460 x 210	CKV400 ESD
1	Component rack ESD	455 x 200 x 290	EPL12 ESD
18	Stacking bin	105 x 165 x 75	1015-4ESD
1	CPU holder ESD	180-225 x 450x50	854 440-49
1	Magnifying lamp Wave LED ESD		TWL ESD
1	Drawer unit 45/26-1	450 x 520 x 260	604 49 001

Designing TPH workstation

- TPH workbench comes with one shelf and a pair of uprights
- Select model either with ESD or laminate bench top
- Equip with accessories.

Workbench TPH

Bench size W x D mm	Shelf size W x D mm	Max load kg	Code	Code ESD
1200 x 700	1200 x 310	300	TPH712	TPH712 ESD
1500 x 700	1500 x 310	300	TPH715	TPH715 ESD
1800 x 700	1800 x 310	300	TPH718	TPH718 ESD
1500 x 900	1500 x 310	300	TPH915	TPH915 ESD
1800 x 900	1800 x 310	300	TPH918	TPH918 ESD





Laminate bench top

- 25 mm low pressure laminate
- Light grey surface
- Plastic edging



ESD bench top

- Light grey laminate surface
- Grey edging
- Thickness 25 mm
- Semi-conductive (ESD)



TPH uprights

1. Lower shelf AT

Name	Size W x D mm	Max load kg	Code
Lower shelf	1080 x 500	50	AT 120TPH
Lower shelf	1380 x 500	50	AT 150TPH
Lower shelf	1680 x 500	50	AT 180TPH

The lower shelf for TPH bench simply hangs on the horizontal bars.



2. Lower steel shelf LSS

Name	Size W x D mm	Max load kg	Code
Lower shelf	1418 x 460	30	LSS 150
Lower shelf	1718 x 460	30	LSS 180
Low M-divider hoops (4 pcs/set)	460 x 315		LDH

Hangs on the horizontal bars. Can be equipped with steplessly adjustable low M-divider hoops.



3. Side worktop

Name	Size W x D mm	Max load kg	Code
Side worktop	400 x 700	35	TP704 ST
Side worktop	400 x 900	35	TP904 ST

Easy to fix to the legs of the bench. Can be fixed on the left or right side of the bench and brackets placed either above or underneath. Height adjustable 575-900 mm from the floor.



Corner workbench TPH KK

Bench size W x D mm	Max load kg	Code	Code ESD
1100 x 1100	150	TPH707 KK	TPH707 KK ESD
1300 x 1300	150	TPH909 KK	TPH909 KK ESD

A corner workbench can be used with two TPH benches (with one H-frame pair) to create a 90 °angle setup. TPH KK unit consists of a worktop, two H-frames and a leg in the middle. Front side 565 mm.

TPH715*

TPH707 KK

TPH715*



* Workbench with one H-frame pair.



Accessories from page 79

Superior range of accessories available for ergonomic TPH workstation.



TPB packing benches



This packing table adapts and grows according to your needs. You don't need to know what your business will look like in two years' time, as you can add and remove accessories as you go. Start small and add from over 50 accessories based on your needs. TPB comes in one flat pack and is easy to assemble. Perfect packing table option for cost-conscious users.

Carefully selected materials, high-quality finishing, epoxy powdercoated steel parts. Laminate bench top, 25 mm low-pressure laminate. Stepless height adjustment with allen-key between 650-900 mm.



- Safe, economic and ergonomic all-in-one choice
- Adapts and grows according to needs
- 50+ accessories and add-on products available
- One flat pack contains all the basic equipment
- Easy to buy, transport and assemble

ACCESSORIES ON PAGE 79

Essential range of accessories available for ergonomic TPB packing bench



READ MORE ABOUT
Treston packing benches
from our separate brochure.



treston.com/catalogues-and-brochures

Designing TPB packing station

- The TPB packing bench comes with a full set of basic accessories. The package includes 2 roll holders, perforated panel, upper steel shelf, divider hoops and an auxiliary steel shelf.
- Further customize with additional accessories

Packing bench TPB

Size W x D mm	Max load kg	Code
1500 x 900 x 650-900	300	TPB915
1800 x 900 x 650-900	300	TPB918

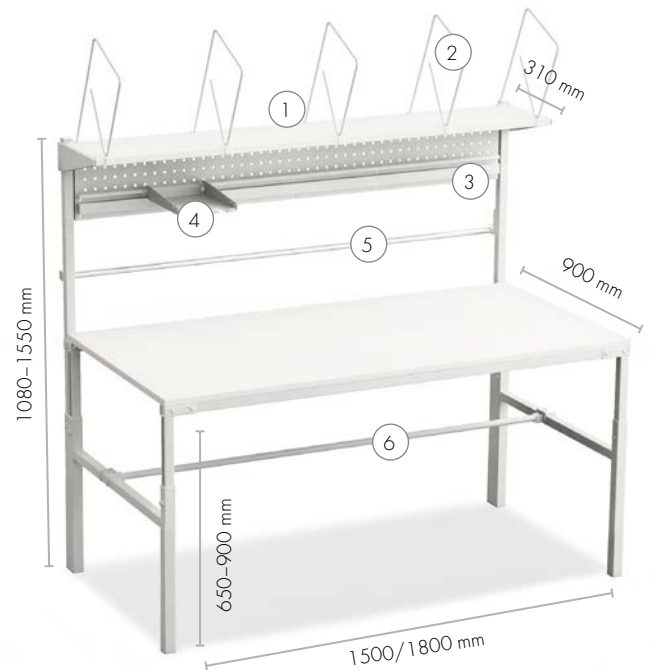

Accessories from page 79

Essential range of accessories available for ergonomic TPB packing bench

Packing bench TPB915/TPB918 includes:

Name	Description	Code TPB915	Code TPB918
1. Height adjustable upper steel shelf	Size 310 x 1500/1800 mm. Max load 30 kg. Fixing positions for Treston lighting units under the shelf.	SS150	SS180
2. Adjustable divider hoops	Five adjustable divider hoops (height 400 mm).	PDH	PDH
3. Height adjustable steel perforated panel with bin rail	Size of the panel 1419/1719 x 255 mm. For auxiliary steel shelves and stacking bins. Max load 20 kg.	PP150	PP180
4. Auxiliary steel shelf	Size 217 x 298 x 20 mm, for A4 paper and tape dispensers (max 2 pcs per shelf). Max load 3 kg.	ASSA4	ASSA4
5. Upper paper roll holder	Height adjustable. Axle diameter 25 mm. Max roll width 1400/1700 mm. Max load 40 kg.	PRH ROLL150	PRH ROLL180
6. Lower paper roll holder	Simply hangs on horizontal bars of legs. Depth adjustable. Axle diameter 25 mm. Max roll width 1350/1650 mm. Max load 40 kg.	PRHL ROLL150	PRHL ROLL180

Lower steel shelf LSS

Name	Size W x D mm	Max load kg	Code
Lower shelf	1418 x 460	30	LSS150
Lower shelf	1718 x 460	30	LSS180
Low M-divider hoops (4 pcs/set)	460 x 315		LDH

Hangs on the horizontal bars. Can be equipped with steplessly adjustable low M-divider hoops.



Side worktop

Name	Size W x D mm	Max load kg	Code
Side worktop	400 x 900	35	TP904 ST

Easy to fix to the legs of the bench. Can be fixed on the left or right side of the bench and brackets placed either above or underneath. Height adjustable 575-900 mm from the floor.



Workshop benches



'Workshop' benches are designed for the most demanding use and environments. Mechanical workshops, garages and heavy industry are environments where chemicals, heavy loads, and strenuous use necessitate robustness. These workbenches are very durable and withstand the toughest conditions. There is a wide range of accessories available.

The Workshop bench is guaranteed for regular use with loads up to 1000 kg.



- Worktop designed for very heavy loads, load capacity up to 1000 kg.
- Very stable on uneven surfaces due to adjustable legs.
- Can be bolted to floor for more stability.
- You can build your personal workstation with our wide range of accessories.

ACCESSORIES ON PAGE 57

Superior range of accessories available for Workshop workstation

Workshop bench examples



Workshop standard workbench

Qty	Name	Size mm	Code
2	Adjustable leg		836 664-49
1	Steel bench top	1500 x 750	836 721-74
1	Spacer bar	1500-2250	836 451-49



Workshop installation workstation

Qty	Name	Size mm	Code
2	Fixed leg		836 303-49
1	Wood top	1500 x 750	836 721-82
1	Drawer unit 55/13-1	550 x 715 x 130	610 07 001
1	Spacer bar	1500-2250	836 451-49



Workshop repair workstation

Qty	Name	Size mm	Code
2	Adjustable leg		836 664-49
1	Steel bench top	1500 x 750	836 721-74
3	Upright tube	30 x 60 x 996	860 367-49
2	Perforated panel	718 x 612	861 512-49
1	Drawer unit 55/37-1	550 x 715 x 370	611 49 001
1	Fixing frame	1500	860 375-49



Workshop workstation

Qty	Name	Size mm	Code
1	Steel bench top	1500 x 750	836 721-74
1	Adjustable leg		836 664-49
1	Fixing frame	1500	860 375-49
3	Upright tube	1359	860 024-49
1	Light/balancer rail	2 x M750	918 49 006
1	Treston NaturLite LED 1200	1180	TNL1200
2	Steel shelf	M750 x 300	836 028-49
2	Suspension rail	M750	859 151-49
5	Stacking bin	149 x 250 x 130	1525-5
7	Stacking bin	105 x 165 x 75	1015-5
1	Perforated tool cabinet	M750	852 629-07
1	Drawer unit 55/66	550 x 715 x 800	612 07 204



Design your own workstation

You can design your own workstation using the available components with the 3D configurator at <https://3d.treston.com>

Designing a Workshop workstation

- Select the appropriate bench top: steel, vinyl or wood.
- Select a support for both ends of the bench top: adjustable or fixed leg or a drawer unit. Legs with castors are also available
- Use a spacer bar to stabilise the bench.
- An accessory frame can be used instead of a spacer bar if upright tubes are specified.
- Equip with accessories starting from page page 57.

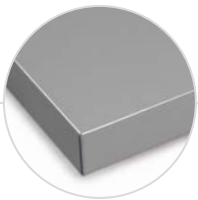
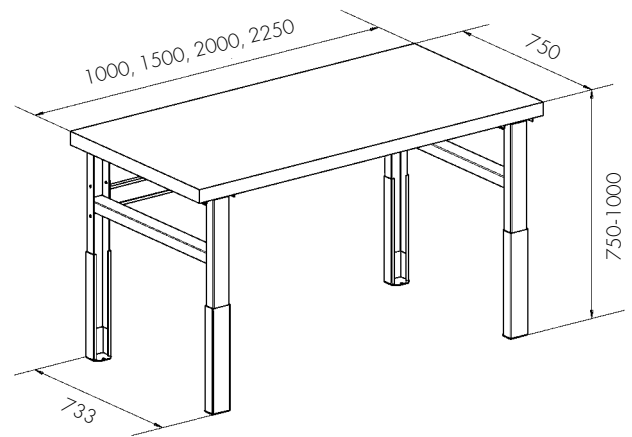

Workshop steel top 1.5 mm

- Epoxy powder coated dark-grey surface
- Grey plastic ends
- Plywood and chipboard core
- Threaded bushings for fixing legs and drawer units
- 3 mm steel top available on request
- Thickness 50 mm



Workshop top with steel edges

- Vinyl top
- Grey vinyl surface
- Galvanized steel front edge
- Plywood and chipboard core
- Threaded bushings for fixing legs and drawer units
- Thickness 50 mm



Workshop top with plastic edges

- Vinyl top
- Grey vinyl surface
- Grey plastic edging
- Plywood and chipboard core
- Threaded bushings for fixing legs and drawer units
- Thickness 50 mm



Workshop wooden top

- Beech multiplex, treated with linseed oil
- Pre-drilled holes for fixing legs and drawer units
- Thickness 40 mm

Workshop bench tops

Bench top Size W x D mm	Steel top 1,5 mm	Max load kg	Steel top 3 mm	Max load kg	Vinyl top with steel edges	Max load kg	Vinyl top with plastic edges	Max load kg	Wood top	Max load kg
1000 x 750	836 720-74	1000	852 652-74	1000	836 723-79	750	836 729-79	750	836 720-82	600
1500 x 750	836 721-74	1000	852 653-74	1000	836 724-79	750	836 726-79	750	836 721-82	600
2000 x 750	836 736-74	1000	852 654-74	1000	836 728-79	750	836 730-79	500	836 736-82	360
2250 x 750	836 722-74	750	852 649-74	750	836 725-79	500	836 727-79	500	836 722-82	360

Workshop legs

Name	Height mm*	Code
Adjustable H-leg (1 pc)	700-950	836 664-49
Fixed H-leg (1 pc)	800	836 303-49
Adjustable H-leg for castors (1 pc)	730-950	836 029-49
Swivel castor with brake** (1 pc)	Ø100	1987
Fixed castor** (1pc)	Ø100	1988

* Height without bench top (including 100 mm castors).

** Load capacity: 500 kg for benches 1000 mm and 1500 mm wide, 300 kg for benches 2000 mm and 2250 mm wide.



Legs with castors are also available



A drawer unit can serve as a leg

Workshop workbenches can be easily extended by using a drawer frame or a leg as a common support for two workbenches.

Spacer bar for Workshop bench

Width mm	Code
1000-1500	852 694-49
1500-2250	836 451-49

Spacer bar is used to stabilise the bench. It is necessary if the bench consists only of legs and bench top.



Accessory frame for Workshop bench

Width mm	Code
1000	852 693-49
1500	860 375-49
2000	860 725-49
2250	860 376-49

Accessory frame is needed if the bench is equipped with upright tubes. Replaces the spacer bar. See upright tubes and compatibility on page 55.



Upright tube modules and compatibility

	Suitable for bench widths (W = Workshop)			
	1000	1500	2000	2250
1 x M750	W	W	W	W
1 x M900	W	W	W	W
1 x M1000	W			
1 x M1500		W	W	W
1 x M1800			W	W
2 x M500	W	W	W	W
2 x M750		W	W	W
2 x M900			W	W
2 x M1000			W	
3 x M500		W	W	W
3 x M750				W
4 x M500			W	

+ **Accessories from page 57**
There is a wide range of accessories available for Workshop bench.

Lower shelves for the Workshop bench

Name	Size W x D mm	Max load kg	Code
Lower shelf for adjustable leg for bench 1000	870 x 648	200	924 49 020
Lower shelf for fixed leg for bench 1000	870 x 648	200	924 49 021
Lower shelf for adjustable leg for bench 1500	1370 x 648	200	924 49 012
Lower shelf for fixed leg for bench 1500	1370 x 648	200	924 49 014
Lower shelf for adjustable leg for bench 2000	1870 x 648	100	924 49 013
Lower shelf for fixed leg for bench 2000	1870 x 648	100	924 49 015
Lower shelf for adjustable leg for bench 2250	2120 x 648	100	924 49 016
Lower shelf for fixed leg for bench 2250	2120 x 648	100	924 49 018

The lower shelves include a backstop.

The Workshop bench can be fitted with a lower shelf for bulky items.



Structure of the bench top

For us, the bench top is an important part of a bench's structure. For example, the Workshop bench top is designed for very heavy loads. Because of the bench top's structure, the bench is very sturdy, even with the highest loads. The feet and the drawers are attached to the threaded bushings in the bench tops.



2. Workbench accessories



Accessories for Concept, TED, Quick Edge, TP and Workshop

Our Concept, TED, Quick Edge TP and Workshop benches can be fitted with the same accessories and they are interchangeable. Other bench models' accessories starting from page 74 (WB accessories). Accessories suitable for all our bench models starting from page 84.

Upright tubes are the basic element for accessorising our industrial furnishings. Accessories are attached to Concept, TED, TP and Workshop benches with the aid of upright tubes or a complete, upright tube module.

The complete upright tube module includes upright tubes, corner bracket pair and straight bracket pair (if module includes more than one horizontal tube). For the Concept bench, the upright tubes are attached to the rear case of the bench. With the TP bench, you also need an accessory frame TPK (page 44). For the TED bench, upright tube pair with a flange is fitted on worktop with screws.

Upright tubes for Concept, TP and Workshop

Name	Size W x D mm	Length mm	Code
Upright tube	30 x 60	500	860 991-49
Upright tube	30 x 60	800	860 142-49
Upright tube	30 x 60	996	860 367-49
Upright tube	30 x 60	1359	860 024-49
Upright tube	30 x 60	1582	860 025-49
Horizontal tube	M500		860 819-49
Horizontal tube	M750		847 402-49
Horizontal tube	M900		840 104-49
Horizontal tube	M1000		854 656-49
Horizontal tube	M1200		854 655-49
Horizontal tube	M1350		850 914-49
Horizontal tube	M1500		854 654-49
Horizontal tube	M1800		854 657-49
Corner bracket pair			848 336-49
Straight bracket			851 827-49

Upright tube modules for Concept and TP

	Suitable for bench widths					Code l=1359 mm h=1075 mm	Code l=1582 mm h=1300 mm
	C	1200	1500	1800	2000		
1 x M750	C	C/TP	C	C	C	900 49 001P	900 49 002P
1 x M900	C/TP	C/TP	C	C	C	901 49 001P	901 49 002P
2 x M500	C	C				902 49 001P	902 49 002P
2 x M750			C/TP	C	C	903 49 001P	903 49 002P
2 x M900				C/TP	C	904 49 001P	904 49 002P
3 x M500			C	C		905 49 001P	905 49 002P
4 x M500					C	906 49 001P	906 49 002P

h = module's height measured from Concept bench's top surface.

Upright tube modules are available also with 996 mm uprights (h=714 mm). Item codes: 90x49003P.

Load capacity 100 kg / module spacing.

Upright tube modules include 5 pcs of cable clips for easy cable management.

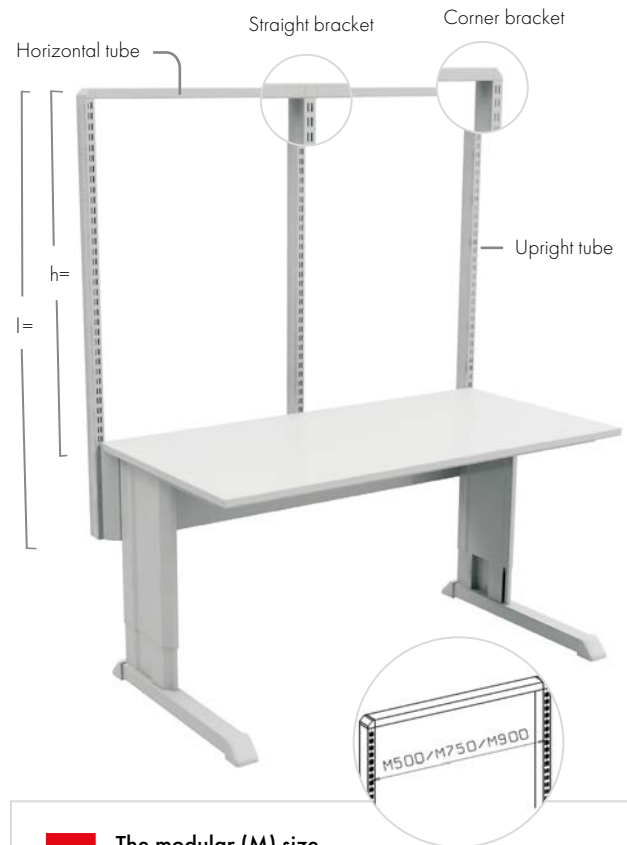

The modular (M) size

The modular (M) size refers to the distance between two upright tubes from the middle of the tube. The modular size is used to find the appropriate accessories.

Upright tube pair with a flange for TED

Size W x D x H mm	Code
70 x 100 x 418	TTP400-49
70 x 100 x 793	TTP790-49
70 x 100 x 997	TTP990-49

Aluminium bracket

Name	Code
Aluminium bracket	846 554-00



Upright tube pair with a flange for TED



A separate aluminium bracket can be used to attach a single tube to any bench.

Light and balancer rail

Apart from the Treston Wave LED ESD and Naturlite LED Wing 500 all luminaires are fitted to light/balancer rails which are height and depth adjustable. Tool balancer rails and sliding pieces facilitate the use of heavy equipment. A tool balancer is fixed to the light/balancer rail.

Light and balancer rail (includes one sliding piece)

Modular size	Width of the front profile mm	Max load kg	Code
2 x M500	1000	15	918 49 001P
2 x M500/1500	1500	15	918 49 002P
4 x M500	2000	15	918 49 003P
M750	750	15	918 49 004P
M750/900	900	15	918 49 013P
M750/1500	1500	15	918 49 005P
2 x M750	1500	15	918 49 006P
3 x M750	2250	15	918 49 012P
M900	900	15	918 49 007P
2 x M900	1800	15	918 49 008P
M900/1500	1500	15	918 49 009P
M1200	1200	15	918 49 010P
M1350	1350	15	918 49 011P

With extension benches you also need a center bracket, code 860 074-49



+

Lighting solutions from page 90.

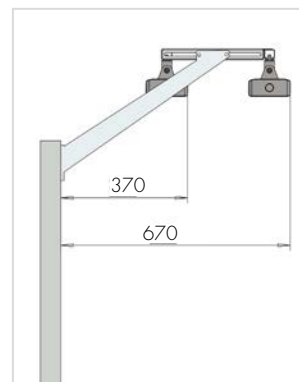
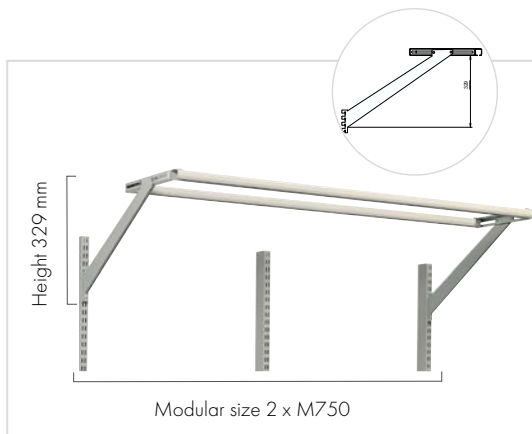
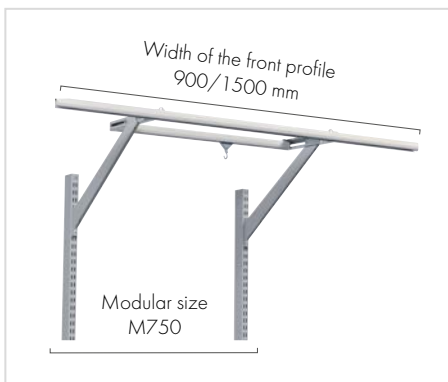

Tool balancers and other supplies

Name	Tool weight kg	Code
Tool balancer 2DU	0,5 - 1	939 502-00
Tool balancer 4DU	1 - 2	939 503-00
Sliding piece with a snap hook		890 557-51



Tool balancer



Sliding piece with a snap hook

Power rails

Power rails come with brackets for fixing to Treston workstations. Rails can be fixed vertically on upright or aluminum profile, horizontally on aluminum profile or on M750 and M900 modules between uprights. With a new bracket set rails can also be fixed straight to table top or perforated panel. Power rail can be mounted on four different angles on brackets. Length of the rail can limit the mounting possibilities.

Power rails

Description	Length	Code
3 sockets + 2 x USB	331	TPR3-001
6 sockets + switch + 2 x USB	468	TPR4-001
6 sockets + switch + 2 x USB + 2 x CAT6A	468	TPR4-003
4 sockets + switch + fault current protection	468	TPR4-004
6 sockets + switch	468	TPR4-005
5 sockets + switch + 2 x USB	683	TPR7-001
5 sockets + switch + 2 x USB + 2 x CAT6A	683	TPR7-003
4 sockets + switch + fault current protection + 2 x USB	683	TPR7-008
10 sockets + switch	683	TPR7-038
6 sockets + switch + 2 x USB	836	TPR9-001
6 sockets + switch + 2 x USB + 2 x CAT6A	836	TPR9-003
6 sockets + switch + fault current protection + 2 x USB	836	TPR9-010
6 sockets + switch + 2 x USB	1400	TPR14-001
6 sockets + switch + fault current protection + 2 x USB	1400	TPR14-010
6 sockets + switch + 2 x USB	1700	TPR17-001
6 sockets + switch + fault current protection + 2 x USB	1700	TPR17-010

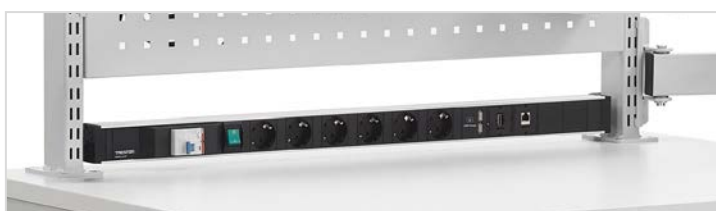

TPR3-001



TPR4-001



TPR7-001



TPR9-001



TPR14-001

+ Further info and images on power rails on page 86.

Distributor for compressed air

Name	In	Out	Fixing	Code
Distributor for compressed air	1	2	vert.	859 861-00
All connections are 3/8"				
Can be fitted to all Treston benches.				



Distributor for compressed air

Shelves

Tiltable top shelf TTS

Module	Size W x D mm	Max load kg	Code
M500	467 x 300	80	TTSM5003-49
M500	467 x 400	80	TTSM5004-49
M750	717 x 300	80	TTSM7503-49
M750	717 x 400	80	TTSM7504-49
M900	870 x 300	80	TTSM9003-49
M900	870 x 400	80	TTSM9004-49
M1000	967 x 300	80	TTSM10003-49
M1000	967 x 400	80	TTSM10004-49
M1200	1167 x 300	80	TTSM12003-49
M1200	1167 x 400	80	TTSM12004-49
M1350	1320 x 300	80	TTSM13503-49
M1350	1320 x 400	80	TTSM13504-49
M1500	1467 x 300	80	TTSM15003-49
M1500	1467 x 400	80	TTSM15004-49
M1800	1773 x 300	80	TTSM18003-49
M1800	1773 x 400	80	TTSM18004-49
M2000	1973 x 300	80	TTSM20003-49
M2000	1973 x 400	80	TTSM20004-49

Max. tilt 20 degrees (depth 300 mm) or 12,5 degrees (depth 400 mm). Front lip height 30 mm. Can also be installed at the back of the shelf.

Cable cover, for TTS-shelf

Module	Size D x H mm	Code
M750	612 x 125 x 19	CCM750-49
M900	815 x 125 x 19	CCM900-49
M1500	1362 x 125 x 19	CCM1500-49
M1800, M2000	1666 x 125 x 19	CCM1800-49

Accessory box for under TTS-shelf

Suitable for	Size D x H mm	Code
Tiltable top shelf TTS depth 300 mm	220 x 300	ABTTS3-41
Tiltable top shelf TTS depth 300 mm	220 x 300	ABTTS3-49
Tiltable top shelf TTS depth 400 mm	220 x 370	ABTTS4-41
Tiltable top shelf TTS depth 400 mm	220 x 370	ABTTS4-49

Includes a blue (-41) or a black ESD (-49) 3020 or 4020 bin.

Steel shelf

Module	Size W x D mm	Max load kg	Code
M500	490 x 300	50	860 804-49
M500	490 x 400	50	860 805-49
M750	740 x 300	50	836 028-49
M750	740 x 400	50	852 770-49
M900	890 x 300	50	852 283-49
M900	890 x 400	50	852 769-49
M1000	990 x 300	50	890 631-49
M1000	990 x 400	50	890 632-49
M1350	1340 x 300	50	860 787-49
M1350	1340 x 400	50	860 788-49
M1500	1490 x 300	50	890 756-49
M1500	1490 x 400	50	890 757-49



Tiltable top shelf M500, M750, M900, M1000, M1200, M1350, M1500, M1800, M2000



Cable cover, TTS-shelf



Accessory box for under TTS-shelf



Steel shelf M500, M750, M900, M1000, M1350, M1500



Due to the dual-purpose shelf brackets, the steel shelf can be used either as tilted 20° or in a horizontal position. The shelf has an integrated edge, which can be used either in the front or back of the shelf, depending on the use of the shelf.

Divider hoops set (4 pcs)

Suitable for	Size D x H mm	Code
Tilttable top shelf TTS depth 300 mm	300 x 400	PDH300-49
Tilttable top shelf TTS depth 400 mm	400 x 400	PDH400-49

Divider pair

Suitable for	Size D x H mm	Code
Steel shelf depth 300 mm	285 x 190	010 004-49
Steel shelf depth 400 mm	385 x 190	010 005-49
Tilttable top shelf TTS depth 300 mm	285 x 190	861 116-49
Tilttable top shelf TTS depth 400 mm	385 x 190	861 118-49

Adjustable shelf

Module	Size W x D mm	Max load kg	Code
M500	470 x 505	100	920 49 001P
M500	470 x 650	100	920 49 002P
M750	720 x 505	100	920 49 005P
M750	720 x 650	100	920 49 006P
M900	870 x 505	100	920 49 009P
M900	870 x 650	100	920 49 010P
M1350	1320 x 505	100	920 49 013P
M1350	1320 x 650	100	920 49 014P

Also available as non ESD-versions (code 41 instead of 49).

Adjustable shelf, stepless depth adjustment

Module	Size W x D mm	Max load kg	Code
M500	470 x 505	50	920 49 003P
M500	470 x 650	50	920 49 004P
M750	720 x 505	50	920 49 007P
M750	720 x 650	50	920 49 008P
M900	870 x 505	50	920 49 011P
M900	870 x 650	50	920 49 012P

Also available as non ESD-versions (code 41 instead of 49).

+

Additional adjustable shelves on page 115.

Extendable shelf

Module	Size W x D mm	Max load kg	Code
M750	720 x 390	30	925 49 002
M900	870 x 390	30	925 49 003

Shelf can be slid out 100%

Document shelf

Module	Size W x D mm	Max load kg	Code
M500	470 x 265	5	860 806-49
M750	720 x 265	5	860 115-49
M900	870 x 265	5	860 399-49

Flow-through shelf

Module	Size W x D mm	Max load kg	Code
M750	718 x 830	150	890 710-49

A flow-through shelf can fit two 400 mm deep bins in depth direction.



Divider hoops set



Divider pair



Adjustable shelf, tilting 0-25°



Steplessly adjustable shelf, tilting 0-25°



Extendable shelf, tilting 0-25°



Document shelf, tilting 10 - 75°



Flow-through shelf

Upright accessories

Adjustable auxiliary shelf

Name	Size W x D mm	Tilting	Max load kg	Code	Code ESD
Adjustable auxiliary shelf	560 x 340	0-25°	15	927 41 001P	927 49 001P
Adjustable auxiliary shelf	605 x 405	0-25°	15	927 41 002P	927 49 002P



Adjustable auxiliary shelf

IT shelves and trays

Name	Size W x D x H mm	Max load kg	Code
Laptop / printer shelf	365 x 365	25	930 49 001P
Keyboard tray for laptop shelf	480 x 270	5	860 904-49
Keyboard and mouse tray for laptop shelf	620 x 270	5	860 903-49
Keyboard tray (attached to the bench top)*	680 x 375 x 106 (outer) 620 x 305 x 90 (inner)	10	925 49 001P



Laptop/printer shelf with arm

* Suitable also for WB, TP, TPH and TPB benches.



Keyboard tray (attached to the bench top)

Holder for Thin Client PC

Name	Size W x D x H mm	Max load kg	Code
Holder for Thin Client PC	250 x 45-65 x 145	5	TCH

Fixed to keyboard tray 860941-49 or 860942-49.



Holder for Thin Client PC

LCD monitor holder for perforated panel

Name	Max load kg	Code
LCD monitor holder for perforated panel	10	890 715-49

Suitable for VESA 75/100



LCD monitor holder for perforated panel

Display bracket for light duty for TED desk

Name	Suitable for	Max load kg	Code
Display bracket for light duty for TED desk	TED	7	TDB-49

Suitable for VESA 75/100



Display bracket for light duty

LCD holder with double arm

Name	Size W x D x H mm	Max load kg	Code
LCD holder with double arm*		15	930 49 002P
Keyboard tray for LCD holder	480 x 260	5	860 941-49
Keyboard and mouse tray for LCD holder	620 x 260	5	860 942-49

Fixed to keyboard tray 860941-49 or 860942-49.

* Suitable for VESA 75/100



LCD holder with double arm

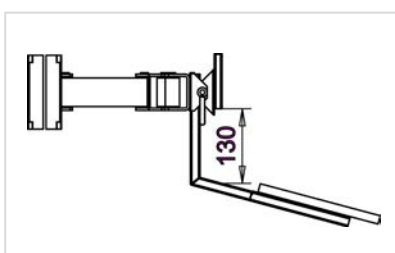

Maximum distance between the LCD holder and keyboard tray



LCD-holder & keyboard tray

Equipment tray

Name	Size W x D mm	Max load kg	Code
Equipment tray	250 x 250 x 90	10	928 49 001P
Equipment tray	500 x 250 x 125	15	928 49 002P
Equipment tray *	500 x 250 x 125	30	928 49 003P

*Comes with heavy arm.



Equipment tray

Bin shelf

Name	Size W x D mm	Max load kg	Code
Bin shelf	560 x 175 x 125	15	928 49 005P
Bin shelf	600 x 220 x 125	15	928 49 006P
Stand for picking bins**	560 x 165 x 355		860 113-49

**Space for 15 picking bins 30-1L-4ESD



Bin shelf



Stand for stacking bins

Document holders

Name	Size W x D mm	Max load kg	Code
Document holder A4	290 x 330	5	928 49 008P
Document holder A3	418 x 330	5	928 49 009P



Document holder

Tool panel

Name	Size W x D mm	Max load kg	Code
Tool panel	267 x 305	5	928 49 010P



Tool panel

Bin rails with arms

Name	Size W x D mm	Max load kg	Code
Curved bin rail with arm	770 x 54	15	929 49 002P
Extension for curved bin rail with arm	770 x 54		860 911-49



Curved bin rail with arm



Extension for curved bin rail with arm

Rotating tool frame

Name	Size W x D mm	Max load kg	Code
Rotating tool panel frame, height-adjustable arm	513 x 320	15	860 864-49P
Rotating tool panel frame, double arm	513 x 320	15	880 865-49P



Rotating tool panel frame

The rotating tool panel frame can be equipped with perforated panels and tool troughs. The rotating tool frame is compatible with all M500 accessories, such as the tool trough and the bin rails.

Plastic bins, hooks and tools in pictures are not included.



Rotating tool panel frame with double arm



Rotating tool panel frame with M500 perforated panel, M500 bin rails and 8 plastic ESD bins



Rotating tool panel frame with M500 perforated panel, aluminium bin rail M500 and auxiliary steel shelf

Accessories for rotating tool frame

Name	Size W x D mm	Max load kg	Code
Perforated panel	470 x 300		860 951-49
Tool trough M500	470 x 150		860 952-49
Bin rail M500	492 x 90	15*	859 150-49
Light bin rail M500	492 x 54	10	860 953-49
Aluminium bin rail M500 for rotating tool panel	486 x 55 x 75	15	BP500C
Auxiliary steel shelf	217 x 298 x 20	3	ASSA4
Auxiliary steel shelf	159 x 254 x 50	2	ASSA5

*Actual bin rail max load 40 kg but with arm 15 kg.

Replacement arms (spare parts)

Name	Length mm	Max load kg	Code
Double arm, 40 mm	200+200	10	880 020-49
Double arm, 60 mm	200+200	15	880 010-49
Heavy arm, 60 mm	287+221	30	860 993-49
Height-adjustable arm with gas spring, 60 mm (height adjustment range 165 mm)	375	15	860 985-49
Height-adjustable profile	55 x 80 x 590	15	860 997-49

LCD screen holder for 60 mm double, heavy or height adjustable arms: 860940-49.



Double arm



Heavy arm



Height-adjustable arm

Height-adjustable profile

When a position changes, the height must be adjusted

Frequent changes in the working position, such as changing from a sitting position to a standing position, require height-adjustable arm (860 985-49). The height-adjustable profile (860 997-49) can be attached to any rack with arm (such as the PC rack) that is pulled down and lifted back up according to the working position. The adjustment range is 450 mm.



Arm adapters for Concept/TP/TED accessories with arms (for example 93049002P)

Profile type	Workbench / trolley model	40 mm arm	60 mm arm
C-profiles	TPH, TPB	-	E824 081-49
AL2X aluminum profiles	WB	890 524-49	890 525-49
Aluminum profiles	WTR	E821 573-49	E821 572-49

Auxiliary top, fixed brackets

Name	Size W x D mm	Max load kg	Code	Code ESD
Auxiliary top left	400 x 500	40	926 41 001P	926 49 001P
Auxiliary top right	400 x 500	40	926 41 002P	926 49 002P



Auxiliary top

Bottle holder

Name	Code
Bottle holder (Ø 100) for upright tube	859 063-49



Bottle holder

Roll holder for upright tube

Name	Code
Roll holder for upright tube (roll ø height 150 mm, width 320 mm)	860 841-49



Roll holder

Adapter set AS

Name	Suitable for	Code
Adapter set for Concept/TED/TP uprights *	MH / MA / MA2	AS2
Adapter for Concept/TED/TP uprights	MA4	AS4

The above adapter set/adapters are needed for fixing MH/MA/MA2/MA4 to the uprights.

* AS2 is also suitable for TPH/TPB C-profiles.



Adapter set AS2

Adapter AS4

LCD bracket MH

Name	Max load kg	Suitable for	Code
LCD bracket MH	15	Upright profiles + AS2	MH

The quick-release mechanism is equipped with the standard used flat-screen mount 75 x 75 and 100 x 100 for the mounting of all normal flat-screens.



LCD bracket MH

LCD swivel arm MA

Name	Max load kg	Suitable for	Code
LCD swivel arm MA	10	Upright profiles + AS2	MA

The quick-release mechanism is equipped with the standard flat-screen mount 75 x 75 and 100 x 100 for the mounting of all normal flat-screens. The arm is double articulated, turns through a radius of 180° and will extend between 95-425 mm from the upright.



LCD swivel arm MA

LCD swivel arm MA2

Name	Max load kg	Suitable for	Code
LCD swivel arm MA2	15	Upright profiles + AS2	MA2

The quick-release mechanism is equipped with the standard, widely used flat-screen mount 75 x 75 and 100 x 100 for the mounting of all normal flat-screens. The arm is double articulated, turns through a radius of 180° and will extend between 95-425 mm from the upright.



LCD swivel arm MA2

LCD screen holder with height adjustable arm MA4

Name	Max load kg	Suitable for	Code
LCD screen holder MA4	2-7	Upright profiles + AS4	MA4

Highly ergonomic and easily height adjustable monitor arm with a gas spring. Easy mounting of the monitor with a quick-release mechanism, standard flat screen mount 75 x 75 mm and 100 x 100 mm for LCD screens. Cable management by cable clips. The double arm turns through a radius of 180 and will extend between 80-500 mm from the upright.



LCD screen holder MA4

Packing accessories

Shelf for packing material SPM

Name	Size W x D x H mm	Max load kg	Suitable for	Code
Shelf for packing material	467 x 600 x 32	60	M500	SPM500-49
Shelf for packing material	717 x 600 x 32	60	M750	SPM750-49
Shelf for packing material	870 x 600 x 32	60	M900	SPM900-49
Shelf for packing material	1167 x 600 x 32	60	M1200	SPM1200-49
Shelf for packing material	1317 x 600 x 32	60	M1350	SPM1350-49
Shelf for packing material	1467 x 600 x 32	60	M1500	SPM1500-49
Shelf for packing material	1773 x 600 x 32	60	M1800	SPM1800-49
Brackets for Concept accessory bar			SPM-shelves	SPMH-49
Adjustable fastening set under worktop	90 x 350 x 355 (free space 285-465 on lower shelf)		SPM-shelves	SPMAF-49
Brackets for upright tube			SPM-shelves	SPMBS-49
Brackets for Treston Quick Edge			SPM-shelves	SPMTQE-49
Divider hoops set (4 pcs)	8 x 400 x 280		SPM-shelves	PDH600-49

The shelf does not include fastening parts.

SPM shelves aren't suitable for TED electric desk. Lower shelves for TED on page 37.



Suitability of lower shelves to 750 and 900 mm deep benches:

- Concept 2000/1800 -> SPM1500 or smaller
- Concept 1500 -> SPM1200 or smaller
- Concept 1200 -> SPM900 or smaller
- Concept 1000 -> SPM500.

Roll holders

Name	Max roll length mm	Max load kg	Suitable for	Code
Roll holder set	635	40	M750	890 547-49P
Roll holder set	785	40	M900	890 548-49P
Roll holder set	1080	40	M1200	890 598-49P
Roll holder set	1400	40	M1500	859 041-49P
Roll holder set	1700	40	M1800	859 042-49P
Roll holder set under worktop 1500	1200	40	M1500	859 044-49P
Roll holder set under worktop 1800	1500	40	M1800	859 045-49P
Paper roll dividers (2 pcs) Ø 170 mm				RD25

Packing material holders

Name	Max width of material mm	Suitable for	Code
Packing material holder for upright tubes	635	M750	PMH750-49
Packing material holder for upright tubes	785	M900	PMH900-49
Packing material holder for upright tubes	1080	M1200	PMH1200-49
Packing material holder for upright tubes	1200	M1350	PMH1350-49
Packing material holder for upright tubes	1400	M1500	PMH1500-49
Packing material holder for upright tubes	1700	M1800	PMH1800-49

Handy holder for packing material that can be taken from a roll. Holds material in place during and after cutting. Can hold two different materials at the same time.



Shelf for packing material and brackets for Concept accessory bar



Shelf for packing material, adjustable fastening set under worktop and divider hoops



Shelf for packing material and brackets for upright tube



Shelf for packing material and brackets for Treston Quick Edge



Roll holder set and paper roll divider



Roll holder set under worktop



Packing material holder for upright tubes

Cutting support for packing material holder

Name	Suitable for	Code
Cutting support for packing material holder	PMH750-49	CSM750-49
Cutting support for packing material holder	PMH900-49	CSM900-49
Cutting support for packing material holder	PMH1200-49	CSM1200-49
Cutting support for packing material holder	PMH1350-49	CSM1350-49
Cutting support for packing material holder	PMH1500-49	CSM1500-49
Cutting support for packing material holder	PMH1800-49	CSM1800-49

Pull-out, ergonomic cutting support for packing material. The support helps to cut packing material more easily e.g. with a carpet knife. Attached to the PMH packing material holder. Distance from the upright tube 250-400 mm. Pull-out distance 150 mm.



Cutting support for packing material holder

Pull-out steel shelf for printer

Name	Size W x D x H mm	Max load kg	Suitable for	Code
Pull-out steel shelf for printer	500 x 510 x 515	35	Concept, TPB	PSP50

Suitable for 750 and 900 deep Concept benches.



Pull-out steel shelf for printer

Printer platform slideable

Name	Size W x D x H mm	Max load kg	Suitable for	Code
Printer platform slideable	315 x 530	30	Concept, TED	859 060-49



Printer platform slideable

Fixed tape dispenser

Name	Suitable for	Code
Fixed tape dispenser	Concept, TPB, TED, Quick Edge	FTD50

Includes screws to fix the dispenser to ASSA4 (see page 68). Max roll Ø 120 mm and width 50 mm.



Fixed tape dispenser

Basic label dispenser

Name	Size W x D x H mm	Suitable for	Code
Basic label dispenser	214 x 128 x 120	Concept, TPB, TED, Quick Edge	BLD20

Can be fixed with screws. Max roll Ø 220 mm and width 210 mm.



Basic label dispenser

Recycling material bin

Name	Size W x D x H mm	Max load kg	Suitable for	Code
Pull-out recycling material bin	286 x 570 x 650	15	Concept, TPB	PRMB3
Recycling material bin	280 x 530 x 585	15	TED	PRMB



Recycling material bin PRMB3



Recycling material bin PRMB

Tool tray PTH

Name	Size W x D mm	Suitable for	Code
Tool tray PTH	1000 x 60	Concept motor benches, TED	PTH100



Tool tray PTH

Stacking bins and shelf bins

Another way of ensuring an ergonomic working position and saving space is to use bin rails. The higher the rails are, the further they are from the workstation. To ensure an ergonomic working position, use the extension bracket pair on the higher rails. The bin rails are available in six standard module sizes.

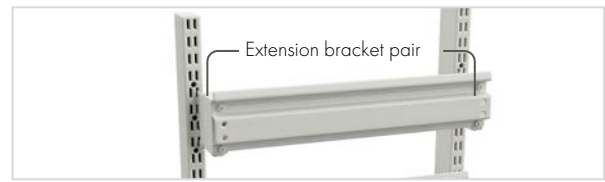

Bin rail with stacking bins.



Light bin rail with stacking bins.



Aluminium bin rail BP and ASSA4

Name	Suitable for module	Size W x D mm	Max load kg	Code
Bin rail	M500	492 x 100	50	859 150-49
Light bin rail	M500	492 x 54	10	860 953-49
Bin rail	M750	742 x 100	50	859 151-49
Light bin rail	M750	742 x 54	10	860 955-49
Bin rail	M900	895 x 100	50	859 152-49
Light bin rail	M900	895 x 54	10	860 956-49
Bin rail	M1000	967 x 100	50	859 156-49
Bin rail	M1200	1167 x 100	50	859 157-49
Bin rail	M1350	1343 x 100	50	859 153-49
Bin rail	M1500	1493 x 100	50	859 154-49
Bin rail	M1800	1799 x 100	50	859 155-49
Extension bracket pair		60	50	860 919-49
Aluminium bin rail M500		486 x 55 x 75	40	BP500C
Aluminium bin rail M750		736 x 55 x 75	40	BP750C
Aluminium bin rail M900		889 x 55 x 75	40	BP900C
Aluminium bin rail M1350		1320 x 55 x 75	40	BP1350C
Aluminium bin rail M1500		1486 x 55 x 75	40	BP1500C
Aluminium bin rail M1800		1792 x 55 x 75	40	BP1800C
Auxiliary steel shelf		217 x 298 x 20	3	ASSA4
Auxiliary steel shelf		159 x 254 x 50	2	ASSA5

Light bin rail is recommended only for the small stacking bins.



Stacking bins

No.	Capacity l	Outer dims W x D x H mm	Inner dims W x D x H mm	Pack pcs	Code.* blue	Code.* red	Code.* ESD black
1.	0,6	105 x 165 x 75	90 x 105 x 65	60	1015-6	1015-5	1015-4 ESD
2.	2,7	149 x 250 x 130	125 x 185 x 115	30	1525-6	1525-5	1525-4 ESD
3.	5,0	186 x 300 x 156	155 x 230 x 140	24	1930-6	1930-5	1930-4 ESD
4.	7,2	186 x 400 x 156	155 x 330 x 140	24	1940-6	1940-5	1940-4 ESD
5.	1,1	99 x 160 x 70	85 x 100 x 62	60	30-1L-6		30-1L-4 ESD
6.	2,2	198 x 160 x 70	175 x 100 x 62	30	30-2L-6		30-2L-4 ESD
7.	2,2	198 x 160 x 70	175 x 100 x 62 (2 fixed length dividers)	30	30-23L-6		30-23L-4 ESD

Labels and cross dividers

Labels + shields	Pack min. order	Cross divider	Pack pcs
E10	60		
E15	30	V-14	30
E20	24	V-19	24
E20	24	V-19	24

* Order number/one item. All bins are also available in grey colour, colour code -3

Fixing stacking bins on the bin rail

Bin rail	M500	M750	M900	M1350	M1500	M1800	Curved bin rail
1015	4	7	8	12	14	17	
1525	3	5	6	9	10	12	
1930 & 1940	2	4	4	7	8	9	
30-1L	5	7	9	13	15	17	5
30-2L & 30-23L	2	3	4	7	7	9	

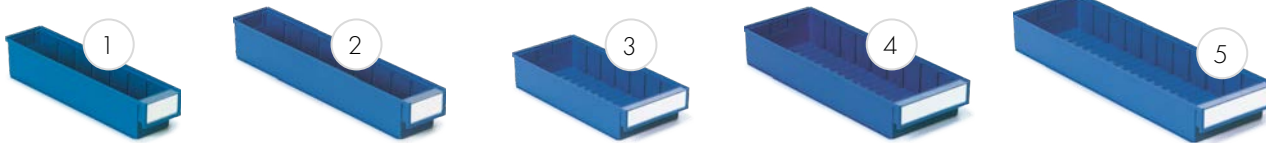

Shelf bins

No.	Capacity l	Outer dims W x D x H mm	Inner dims W x D x H mm	Pack pcs	Code* blue	Code.* red	Code.* ESD black	Code*	Number/bin
1.	1,9	92 x 400 x 82	75 x 357 x 70	30	4010-6	4010-5	4010-4 ESD	D-10	6
2.	2,4	92 x 500 x 82	75 x 457 x 70	30	5010-6	5010-5	5010-4 ESD	D-10	8
3.	4,2	186 x 400 x 82	167 x 357 x 70	15	4020-6	4020-5	4020-4 ESD	D-20	6
4.	5,3	186 x 500 x 82	167 x 457 x 70	15	5020-6	5020-5	5020-4 ESD	D-20	8
5.	6,5	186 x 600 x 82	167 x 557 x 70	15	6020-6	6020-5	6020-4 ESD	D-20	10

*Order number/one item. All bins are also available in grey colour, colour code -3

Cross dividers

Sustainable wood-based bioplastic shelf bins on page 199.

Other supplies

Name	Description	Size W x D x H mm	Code
Stacking bin set	Four bins made of blue polypropylene (PP).	2 pcs 230 x 155 x 140 2 pcs 185 x 125 x 115	SBS4
Tool holder box	With two blue plastic bins type 3020.	400 x 300 x 150	PPH TXL



Stacking bin set



Tool holder box

+ Entire bin selection on page 197.

Perforated panels

Name	Module	Size W x H mm	Code
Perforated back panel	M500	468 x 389	861 501-49
Perforated back panel	M750	718 x 194	861 510-07
Perforated back panel	M750	718 x 389	861 511-49
Perforated back panel	M750	718 x 612	861 512-07/-49
Perforated back panel, insulated	M750	718 x 612	861 701-07/-49
Perforated back panel	M750	718 x 1003	861 514-07/-49
Perforated back panel	M900	871 x 389	861 516-49
Perforated back panel	M900	871 x 612	861 517-07/49
Perforated back panel	M900	871 x 1003	861 519-07/49
Perforated back panel	M1000	968 x 389	861 532-49
Perforated back panel	M1000	968 x 612	861 538-07/49
Perforated back panel	M1000	968 x 1003	861 535-07
Perforated back panel	M1200	1168 x 389	861 533-49
Perforated back panel	M1350	1318 x 389	861 521-49
Perforated back panel	M1500	1474 x 389	861 526-49
Perforated back panel	M1800	1774 x 389	861 531-49

Fastened to the upright tubes (see page 57).

Auxiliary steel shelf for perforated panel

Size W x D x H mm	Suitable for	Code
159 x 243 x 56	Perforated panel	ASSA5PP

Auxiliary steel shelf for A5 documents, tape dispenser or handheld scanner. Attached to the perforated panel.

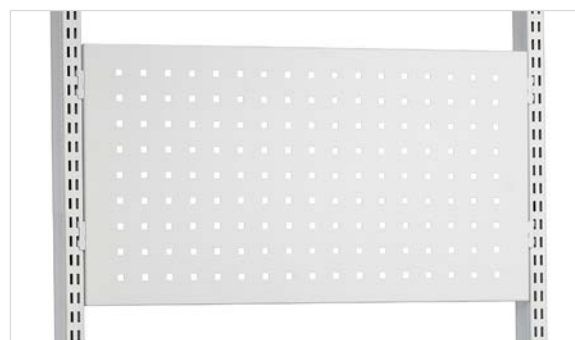

+ Panel hooks from page 184.



Auxiliary steel shelf for perforated panel

Small storage solutions

Perforated tool cabinet

Name	Module size	Size W x D x H mm	Max load kg	Code
Perforated tool cabinet, blue	M500	470 x 250 x 600	20	854 039-07
Perforated tool cabinet, blue	M750	720 x 255 x 900	60	852 629-07
Shelf for M750 perforated tool cabinet		715 x 175 x 15	10	836 273-49

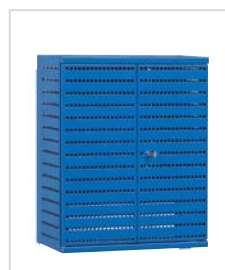

Perforated tool cabinet M500



Perforated tool cabinet M750

Sliding door cabinet

Name	Module size	Size W x D x H mm	Max load kg	Code
Sliding door cabinet	M750	720 x 370 x 400	40	860 970-49



Sliding door cabinet

File cabinet

Name	Module size	Size W x D x H mm	Max load kg	Code
File cabinet with two shelves	M750	720 x 330 x 900	60	860 980-49
Shelf + brackets		712 x 296 x 26		860 929-49



File cabinet

Personal safety equipment cabinet

Name	Module size	Size W x D x H mm	Max load kg	Code
Personal safety equipment cabinet	M750	720 x 330 x 900	60	860 987-07



Personal safety equipment cabinet

PC/folder box

Name	Size W x D x H mm	Max load kg	Code
PC/folder box, fitted to the upright tubes	130 x 290 x 330	5	860 983-49



PC/folder box

CPU cabinets and holders

1. CPU/printer holder, bar clamp

Size W x D x H mm	Max load kg	Suitable for	Code
>150 x 500 x 85	20	Concept with accessory bar	860 551-49



2. CPU holder

Size W x D x H mm	Max load kg	Suitable for	Code
180-225 x 450 x 50	20	Concept (allen key and hand crank)	860 552-49



3. CPU holder

Size W x D x H mm	Max load kg	Suitable for	Code
180-225 x 450 x 50	20	Concept motor	860 740-49

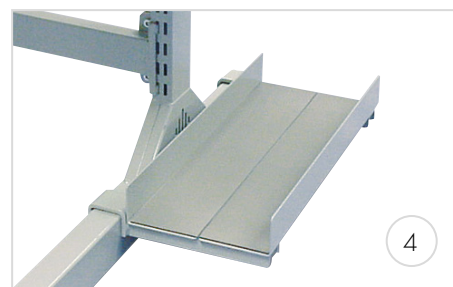

4. CPU holder

Size W x D x H mm	Max load kg	Suitable for	Code
180-225 x 450 x 50	20	TP upright frame	860 553-49



5. CPU holder

Size W x D x H mm	Max load kg	Suitable for	Code
180-225 x 450 x 50	20	TP/TPH benches	854 440-49



6. PC stand CPU

Width	Height	Suitable for	Code
130-240 mm	39-500 mm	TED, TP/TPH, Concept (depth 750/900 mm) benches	CPU
340-460 mm	180-285 mm		

An adjustable holder for either vertical or horizontal CPU, to mount underneath the table worktop.

Cable management

Cable ducts

Name	Size W x H mm	Suitable for module	Code
Cable duct	467 x 360	M500	860 808-49
Cable duct	717 x 360	M750	860 044-49
Cable duct	870 x 360	M900	860 045-49

Suitable only for Concept bench. Fitted to upright tube.

Cable ducts hide the untidy cables from other equipment. This makes it easy to keep the back of the workstation and its surroundings tidy.



Hide wires and cables with a cable duct.

Horizontal cable troughs

Name	Size W x D x H mm	Suitable for module	Code
Horizontal cable trough	737 x 97 x 45	M750	854 553-49
Horizontal cable trough	890 x 97 x 45	M900	854 554-49
Horizontal cable trough	1187 x 97 x 45	M1200	854 555-49
Horizontal cable trough	1337 x 97 x 45	M1350	890 551-49
Horizontal cable trough	1487 x 97 x 45	M1500	854 556-49
Horizontal cable trough	1793 x 97 x 45	M1800	854 557-49

Horizontal troughs effectively conceal the cables, without preventing maintenance access.



Fitted to upright tubes, the horizontal cable trough enables cables to be hidden at the top of the workstation.



Vertical cable trough

Vertical cable trough

Name	Size W x D x H mm	Code
Vertical cable trough	52 x 62 x 1360	861 130-49

The vertical cable trough is fitted on the side of the upright tube.

Treston Cable Tidy

Name	Size W x D x H mm	Suitability	Code
Treston Cable Tidy	800 x 62 x 100	TED	TCT-49

Treston cable tidy hides the cables below the worktop.

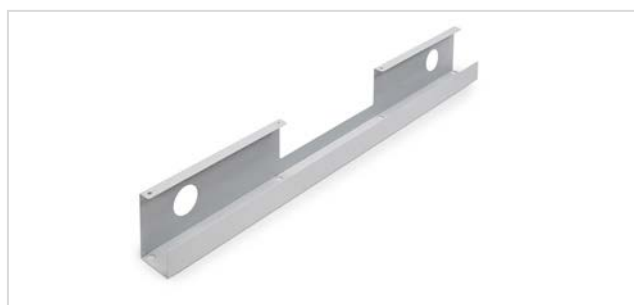

Treston Cable Tidy for TED

CC cable clip set CC5

Name	Suitable for	Code
Cable clip set (incl. 5 pcs)	Upright tubes	CC5

For easy cable management, suitable for up to five cables.



CC cable clip set CC5

Footrests

Footrest, floor

Size W x D mm	Height	Tilting	Suitable for	Code ESD
550 x 350	100	5-30°	All benches	860 947-49



Footrest, floor

Footrest, floor, height adjustable

Size W x D mm	Height	Tilting	Suitable for	Code ESD
550 x 350	90-280	5-30°	All benches	860 137-49



Footrest, floor, height adjustable

Footrest, floor, with gas action

Size W x D mm	Height	Tilting	Suitable for	Code ESD
550 x 350	90-260	5-30°	All benches	860 224-49



Footrest, floor, with gas action

Footrest, bar

Size W x D mm	Height	Tilting	Suitable for	Code ESD
550 x 350	90-280	5-30°	Concept	860 136-49

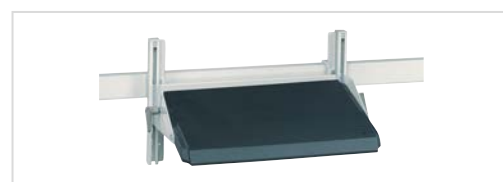

Footrest, bar

Footrest, bar, with gas action

Size W x D mm	Height	Tilting	Suitable for	Code ESD
550 x 350	90-260	5-30°	Concept	860 196-49



Footrest, bar, with gas action

Accessory bars

Name	Bench frame width mm	Depth adjustment mm	Code
Accessory bar Concept	1000	-	860 084-49
Accessory bar Concept	1200	-	860 085-49
Accessory bar Concept	1500	150	860 088-49
Accessory bar Concept	1500	-	860 086-49
Accessory bar Concept	1800	150	860 089-49
Accessory bar Concept	1800	-	860 083-49
Accessory bar Concept	2000	150	860 090-49

The accessory bar can be used to fix a footrest or a CPU/printer holder. The accessory bar is included with the hand crank and motor adjustable Concept benches.

Accessories for WB

Upright profiles AL2X

Size W x H mm	Suitable for	Code	Code ESD
1063 x 900	WB811	AL2X110 W	AL2X110 W
1489 x 900	WB815	AL2X150 W	AL2X150 W
1789 x 900	WB818	AL2X180 W	AL2X180 W

Needed for mounting accessories to WB benches. Includes 2 vertical and 1 horizontal profile. With 3 cable clips (CC8). Load capacity 100 kg/AL2X.

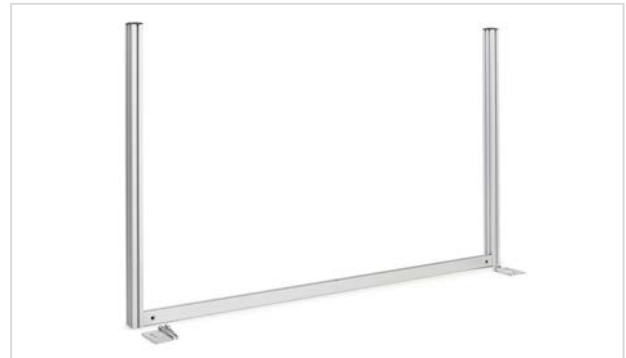

Upright profiles AL2X

Accessory frame AKK

Size W x D mm	Suitable for	Code	Code ESD
730 x 540	AL2X150 W AL2X180 W	AKK70	AKK70
690 x 500 + 690 x 500	AL2X150 W	AKK150	AKK150
690 x 500 + 990 x 500	AL2X180 W	AKK180	AKK180

The accessory frame divides the space between the upright profiles into 2 modules. AKK frame includes 1 vertical and 1 horizontal profile. Useable height 500 mm.



Accessory frame AKK

Support bracket HSB

Length mm	Suitable for	Code	Code ESD
1073	AL2X110 W	HSB110	HSB110
1500	AL2X150 W	HSB150	HSB150
1800	AL2X180 W	HSB180	HSB180

Support bracket of steel for suspending power tools and lighting units. Mount on upright profiles.



Support bracket HSB

Cable tidy WBCT

Size W x D x H mm	Suitable for	Code	Code ESD
948 x 64 x 204	WB811	WBCT110	WBCT110
1375 x 64 x 204	WB815	WBCT150	WBCT150
1675 x 64 x 204	WB818	WBCT180	WBCT180

Mount on leg frame. We recommend using the cable tidy WBCT with WB Allen-key adjustable benches. The cable tidy is standard equipment on WB C and WB EL models.



Cable tidy WBCT

Shelf ALH

Size W x D mm	Suitable for	Code	Code ESD
1073 x 310	AL2X110 W, combination AL2X180 W + AKK180	ALH110	ALH110 ESD
1500 x 310	AL2X150 W	ALH150	ALH150 ESD
1800 x 310	AL2X180 W	ALH180	ALH180 ESD

Height adjustable shelf. 25 mm laminated particle board. Load capacity 50 kg. Mount on upright profiles.



Shelf ALH

Lower shelf AT

Size W x D mm	Max load kg	Suitable for	Code	Code ESD
828 x 400	50	WB811	AT110 WB	AT110 WB ESD
1255 x 400	50	WB815	AT150 WB	AT150 WB ESD
1555 x 400	50	WB818	AT180 WB	AT180 WB ESD

Height adjustable lower shelf, 25 mm laminated particle board. Mount between the legs.



Lower shelf AT

Divider hoops PDH

Height mm	Suitable for	Code	Code ESD
400	ALH	PDH	PDH

Used in combination with shelf ALH. Comes in sets of 5.



Divider hoops PDH

Backstop LIST

Size W x D x H mm	Suitable for	Code ESD
1400 x 52 x 27	ALH150, ALH150 ESD, AT150 WB, AT150 WB ESD	LIST150
1700 x 52 x 27	ALH180, ALH180 ESD, AT180 WB, AT180 WB ESD	LIST180

Prevents items from falling off the shelf. Can be fixed on the lower shelf AT or on the shelf ALH.



Backstop LIST

Adjustable shelf ASH

Size W x D mm	Suitable for	Code	Code ESD
660 x 400	AKK70, AKK150, AKK180	ASH70	ASH70 ESD
960 x 400	AKK180, AL2X110W	ASH100	ASH100 ESD

Continuous adjustment for depth, height and angle. Shelf of 25 mm laminated particle board. Lipped front edge. Load capacity 35 kg static load. Mount on accessory frame AKK.



Adjustable shelf ASH

Swivel arm with tray AKV

Size W x D mm	Suitable for	Code	Code ESD
460 x 210 (tray)	AL2X upright profiles	AKV400	AKV400 ESD

Lockable, angle adjustable steel tray with swivel radius of 360°. Length of swivel arm 590 mm. Max. load 15 kg.



Swivel arm with tray AKV

Keyboard shelf WKA

Size W x D mm	Suitable for	Code	Code ESD
500 x 220 (shelf)	AL2X upright profiles	WKA	WKA ESD

Keyboard shelf with swivel arm. Epoxy powder coated steel. Load capacity 15 kg. Arm length 220 mm.



Keyboard shelf WKA

Component rack EPL

Size W x D x H mm	Suitable for	Shelves number	Code ESD
455 x 200 x 290	AKV	3	EPL12 ESD

Rack with three fixed shelves. Semiconductive epoxy powder coated steel in light grey (RAL 7035). Bins ordered separately, page 50. Component rack holds: 12 stacking bins 1015-4ESD or 12 picking bins 30-1L-4ESD or 6 picking bins 30-2L-4ESD or 6 picking bins 30-23L-4ESD.



Component rack EPL

Document stand WDA

Size W x H mm	Suitable for	Code	Code ESD
440 x 300	AL2X upright profiles	WDA	WDA ESD

Document stand A3 with swivel arm. Epoxy powder coated steel: light grey. Arm length 220 mm. Tilt 75°.



Document stand WDA

Perforated panel ARL

Size W x H mm	Suitable for	Code	Code ESD
668 x 500	AKK70, AKK150	ARL70	ARL70
968 x 500	AKK180, AL2X110W	ARL100	ARL100

Mount on accessory frame AKK. The size of the perforation is 9 x 9 mm, center to center 38 mm.

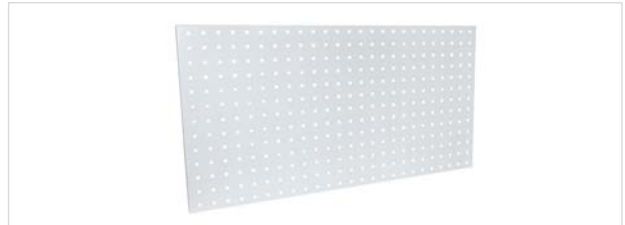

Perforated panel ARL

Auxiliary steel shelf for perforated panel

Size W x D x H mm	Suitable for	Code
159 x 243 x 56	Perforated panel ARL	ASSA5PP

Auxiliary steel shelf for A5 documents, tape dispenser or handheld scanner. Attached to the perforated panel.



Auxiliary steel shelf for perforated panel

Bin profile BP

Length mm	Suitable for	Code	Code ESD
685	AKK 70, AKK150, AKK180	BP70	BP70 ESD
985	AKK180, AL2X110W	BP100	BP100 ESD

Aluminium profile for stacking and picking bins. Mount on accessory frame AKK.



Bin profile BP

Auxiliary steel shelf ASSA

Size W x D x H mm	Suitable for	Code
217 x 298 x 20	BP	ASSA4
159 x 254 x 50	BP	ASSA5

Shelf for A4/A5 paper and tape dispensers (max 2 pcs per shelf). Mounted on bin profile. Max load 3 kg.



Auxiliary steel shelf ASSA4

Recycling material bin PRMB

Size W x D x H mm	Suitable for	Code
282 x 590 x 600	WB, TP, TPH, TPB and TED	PRMB
The 60 ltr bin with steel brackets has a maximum load of 15 kg and can be positioned on either side of the bench.		
282 x 590 x 650	WB, Concept, TP, TPH and TPB	PRMB3
This pull-out model with steel rails is fixed under the worktop. Bin 60 ltr. Max load 15 kg.		



Recycling material bin PRMB



Recycling material bin PRMB3

Tool tray PTH

Size W x D mm	Suitable for	Code
1000 x 60	WB and TED benches, Concept motor benches.	PTH100
The tool tray guarantees a clean working space, while tools are close to hand.		



Tool tray PTH

Tool holder box PPH

Size W x D x H mm	Suitable for	Code
400 x 300 x 140	WB, TP, TPH, Concept, TPB, TED	PPH TXL
PPH TXL with two blue plastic bins type 3020.		

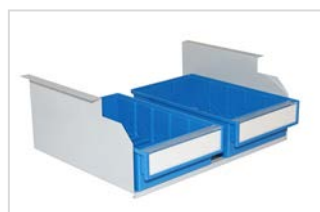

Tool holder box PPH



Bottle holder CH

Bottle holder CH

Size W x D x H mm	Ø mm	Suitable for	Code
110 x 105 x 120	80	AL2X upright profiles	CH
Practical holder for bottle or cup. Made of black polypropylene.			

Cable clip set CC

Set	Suitable for	Code	Code ESD
5 pieces	AL2X upright profiles	CC8	CC8
The cable clip set will hold cables etc. securely and neatly in place along the bench frame. The clips locate in the 8 mm profile slot.			



Cable clip set CC

Power rails

Description	Length	Code
3 sockets + 2 x USB	331	TPR3-001
6 sockets + switch + 2 x USB	468	TPR4-001
6 sockets + switch + 2 x USB + 2 x CAT6A	468	TPR4-003
4 sockets + switch + fault current protection	468	TPR4-004
6 sockets + switch	468	TPR4-005
5 sockets + switch + 2 x USB	683	TPR7-001
5 sockets + switch + 2 x USB + 2 x CAT6A	683	TPR7-003
4 sockets + switch + fault current protection + 2 x USB	683	TPR7-008
10 sockets + switch	683	TPR7-038
6 sockets + switch + 2 x USB	836	TPR9-001
6 sockets + switch + 2 x USB + 2 x CAT6A	836	TPR9-003
6 sockets + switch + fault current protection + 2 x USB	836	TPR9-010
6 sockets + switch + 2 x USB	1400	TPR14-001
6 sockets + switch + fault current protection + 2 x USB	1400	TPR14-010
6 sockets + switch + 2 x USB	1700	TPR17-001
6 sockets + switch + fault current protection + 2 x USB	1700	TPR17-010

More information and images on power rails on page 86.



Power rails

PC stand CPU

Width	Height	Suitable for	Code
130-240 mm	395-500 mm	WB, TP/TPH, Concept (depth 750/900 mm) benches, TED	CPU
340-460 mm	180-285 mm	SAP, WTR and Concept trolleys	

An adjustable holder for either vertical or horizontal CPU, to mount underneath the table worktop.



PC stand CPU

LCD bracket MH

Max load kg	Suitable for	Code
15	AL2X upright profiles	MH

The quick-release mechanism is equipped with the standard used flat-screen mount 75 x 75 and 100 x 100 for the mounting of all normal flat-screens.



LCD bracket MH

LCD swivel arm MA

Max load kg	Suitable for	Code
10	AL2X upright profiles	MA

The quick-release mechanism is equipped with the standard flat-screen mount 75 x 75 and 100 x 100 for the mounting of all normal flat-screens. The arm is double articulated, turns through a radius of 180° and will extend between 95-425 mm from the upright.



LCD swivel arm MA

LCD swivel arm MA2

Max load kg	Suitable for	Code
15	AL2X upright profiles	MA2

The quick-release mechanism is equipped with the standard, widely used flat-screen mount 75 x 75 and 100 x 100 for the mounting of all normal flat-screens. The arm is double articulated, turns through a radius of 180° and will extend between 95-425 mm from the upright.



LCD swivel arm MA2

LCD screen holder with height adjustable arm MA4

Max load kg	Suitable for	Code
2-7 kg	AL2X upright profiles	MA4

Highly ergonomic and easily height adjustable monitor arm with a gas spring. Easy mounting of the monitor with a quick-release mechanism, standard flat screen mount 75 x 75 mm and 100 x 100 mm for LCD screens. Cable management by cable clips. The double arm turns through a radius of 180 and will extend between 80-500 mm from the upright.



LCD screen holder MA4

Tablet bracket MY

Suitable for	Code
MH, MA or MA2	MY

For 7-10" tablets. Requires either an MH, MA or MA2 swivel arm.



Tablet bracket MY

Accessories for TPH and TPB

Tool and lighting support KT

Size W x D mm	Suitable for	Code	Code ESD
1200 x 600	TPH712	KT120	KT120
1500 x 600	TPH715/915 and TPB915	KT150	KT150
1800 x 600	TPH718/918 and TPB918	KT180	KT180
Extra C-profile	1500	KT150	SPR150
Extra C-profile	1800	KT180	SPR180

For suspending power tools and lighting units. Includes one C-profile bar with sliding hook.



Tool and lighting support KT

High upright profile pair HKCP

Height mm	Suitable for	Code	Code ESD
1470	TPH/TPB	HKCP147	HKCP147

High upright profile pair provides more space for TPH accessories



High upright profile pair HKCP

Cable tidy TPHCT

Size W x D x H mm	Suitable for	Code	Code ESD
1115 x 45 x 205	TPH712	TPHCT120	TPHCT120
1415 x 45 x 205	TPH715/915	TPHCT150	TPHCT150
1715 x 45 x 205	TPH718/918	TPHCT180	TPHCT180

Mounted between C-profiles below worktop. Of perforated epoxy powder coated steel.



Cable tidy TPHCT

Metal shelf TH

Size W x D mm	Max load kg	Suitable for	Code	Code ESD
1119 x 145	30	TPH712	TH120	TH120 ESD
1419 x 145	30	TPH715/915, TPB915	TH150	TH150 ESD
1719 x 145	30	TPH718/918, TPB918	TH180	TH180 ESD

Adjustment for depth, height and angle. For stacking and picking bins. Load capacity 30 kg.



Metal shelf TH

Auxiliary shelf SH

Size W x D mm	Max load kg	Suitable for	Code	Code ESD
1200 x 310	50	TPH712	SH120	SH120 ESD
1500 x 310	50	TPH715/915	SH150	SH150 ESD
1800 x 310	50	TPH718/918	SH180	SH180 ESD

Height adjustable shelf. 25 mm laminated chipboard.



Auxiliary shelf SH

Divider hoops PDH

Height mm	Suitable for	Code	Code ESD
400	SH shelf	PDH	PDH

Used in combination with shelf SH. Comes in sets of 5.



Divider hoops PDH

Backstop LIST

Size W x D x H mm	Suitable for	Code ESD
1400 x 52 x 27	AT 150TPH, SH150	LIST150
1700 x 52 x 27	AT 180TPH, SH180	LIST180

Prevents items from falling off the shelf.



Backstop LIST

Bin profile BP

Width mm	Max load kg	Suitable for	Code	Code ESD
profile 1115	15	TPH712	BP120	BP120 ESD
profile 1415	15	TPH715/ 915, TPB915	BP150	BP150 ESD
profile 1715	15	TPH718/ 918, TPB918	BP180	BP180 ESD

Aluminium profile for stacking and picking bins.



Bin profile BP

Auxiliary steel shelf ASSA

Size W x D x H mm	Suitable for	Code
217 x 298 x 20	BP	ASSA4
159 x 254 x 50	BP	ASSA5

Shelf for A4/A5 paper and tape dispensers (max 2 pcs per shelf). Mounted on bin profile. Max load 3 kg.



Auxiliary steel shelf ASSA

Stacking bin set SBS4

Size W x D x H mm	Suitable for	Code
2 pcs 230 x 155 x 140	BP	SBS4
2 pcs 185 x 125 x 115		

Four bins made of blue polypropylene (PP).



Stacking bin set SBS4

Swivel arm with tray CKV

Size W x D mm	Max load kg	Suitable for	Code	Code ESD
Tray 460 x 210	15	TPH/TPB	CKV400	CKV400 ESD

Swivel arm with lockable, angle adjustable steel tray. Load 15 kg. Mount on C-profile.



Swivel arm with tray CKV

Component rack EPL

Size W x D x H mm	Suitable for	Shelves number	Code ESD
455 x 200 x 290	CKV	3	EPL12 ESD

Rack with three fixed shelves. Of semiconductive epoxy powder coated steel in light grey (RAL 7035).



Component rack EPL, swivel arm with tray AKV and bins

Perforated panel RL

Size W x H mm	Suitable for	Code	Code ESD
1115 x 750	TPH712	RL120	RL120
1415 x 750	TPH715/ 915	RL150	RL150
1715 x 750	TPH718/ 918	RL180	RL180
Connector set for RL perforated panels	TPH	RK1	RK1

Robust, perforated steel panel. 9 mm perforations at 38 mm centres. Mount on TPH-benches with connectors RK 1. Can also be attached to a wall with screws (included).

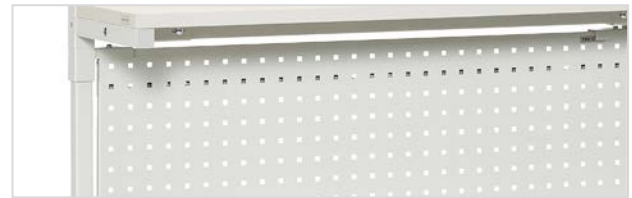

Perforated panel RL

Auxiliary steel shelf for perforated panel

Size W x D x H mm	Suitable for	Code
159 x 243 x 56	Perforated panel RL	ASSA5PP

Auxiliary steel shelf for A5 documents, tape dispenser or handheld scanner. Attached to the perforated panel.



Auxiliary steel shelf for perforated panel

Tool holder box PPH

Size W x D x H mm	Suitable for	Code
400 x 300 x 140	All benches	PPH TXL

PPH TXL with two blue plastic bins type 3020.



Tool holder box PPH

Recycling material bin PRMB

Size W x D x H mm	Suitable for	Code
530 x 280 x 585	WB, TP, TPH, TPB, TED benches	PRMB

The 60 ltr bin with steel brackets has a maximum load of 15 kg and can be positioned on either side or rear of the bench.



Recycling material bin PRMB

Recycling material bin PRMB3

Recycling material bin PRMB3

Size W x D x H mm	Suitable for	Code
286 x 570 x 650	WB, Concept, TP, TPH and TPB	PRMB3

This pull-out model with steel rails is fixed under the worktop. Bin 60 ltr. Max load 15 kg.

Pull-out steel shelf for printer

Size W x D x H mm	Max load kg	Suitable for	Code
500 x 510 x 515	35	Concept, TPB	PSP50

Suitable for 750 and 900 deep Concept benches.



Pull-out steel shelf for printer

CPU holder

Size W x D x H mm	Max load kg	Suitable for	Code
180-225 x 450 x 50	20	TP/TPH	854 440-49



CPU holder

Cable clip set CC

Set	Max load kg	Suitable for	Code	Code ESD
5 pcs/set	15	TPH/TPB	CC12	CC 12

The cable clip set will hold cables etc. securely and neatly in place along the bench frame. The clips locate in the 12 mm profile slot.



Cable clip set CC

LCD bracket MH

Max load kg	Suitable for	Code
15	TPH/TPB+ AS2	MH

The quick-release mechanism is equipped with the standard used flat-screen mount 75 x 75 and 100 x 100 for the mounting of all normal flat-screens.
Adapter set AS2 is needed for mounting LCD bracket MH to TPH benches, ordered separately.



LCD bracket MH

LCD swivel arm MA

Max load kg	Suitable for	Code
10	TPH/TPB+ AS2	MA

The quick-release mechanism is equipped with the standard flat-screen mount 75 x 75 and 100 x 100 for the mounting of all normal flat-screens. The arm is double articulated, turns through a radius of 180° and will extend between 95-425 mm from the upright.
Adapter set AS2 is needed for mounting LCD swivel arm MA to TPH benches, ordered separately.



LCD swivel arm MA

LCD swivel arm MA2

Max load kg	Suitable for	Code
15	TPH/TPB+ AS2	MA2

The quick-release mechanism is equipped with the standard, widely used flat-screen mount 75 x 75 and 100 x 100 for the mounting of all normal flatscreens. The arm is double articulated, turns through a radius of 180° and will extend between 95-425 mm from the upright.
Adapter set AS2 is needed for mounting LCD swivel arm MA2 to TPH benches, ordered separately.



LCD swivel arm MA2

LCD screen holder with height adjustable arm MA4

Max load kg	Suitable for	Code
2-7	TPH/TPB + AS4C	MA4

Highly ergonomic and easily height adjustable monitor arm with a gas spring. Easy mounting of the monitor with a quick-release mechanism, standard flat screen mount 75 x 75 and 100 x 100 for LCD screens. Cable management by cable clips. The double arm turns through a radius of 180° and will extend between 80-500 mm from the upright.
Adapter AS4C is needed for mounting LCD swivel arm MA4 to TPH/TPB benches, ordered separately.



LCD screen holder MA4

Adapter set AS

Suitable for	Code
MH / MA / MA2	AS2
MA4	AS4C

The above adapter sets / adapters are needed for fixing MH/MA/MA2/MA4 arms to the TPH/TPB C-profiles



Adapter set AS2



Adapter AS4C

Tablet bracket MY

Suitable for	Code
MH, MA or MA2	MY

For 7-10" tablets. Requires either an MH, MA or MA2 swivel arm.



Tablet bracket MY

Power rails

Description	Length	Code
3 sockets + 2 x USB	331	TPR3-001
6 sockets + switch + 2 x USB	468	TPR4-001
6 sockets + switch + 2 x USB + 2 x CAT6A	468	TPR4-003
4 sockets + switch + fault current protection	468	TPR4-004
6 sockets + switch	468	TPR4-005
5 sockets + switch + 2 x USB	683	TPR7-001
5 sockets + switch + 2 x USB + 2 x CAT6A	683	TPR7-003
4 sockets + switch + fault current protection + 2 x USB	683	TPR7-008
10 sockets + switch	683	TPR7-038
6 sockets + switch + 2 x USB	836	TPR9-001
6 sockets + switch + 2 x USB + 2 x CAT6A	836	TPR9-003
6 sockets + switch + fault current protection + 2 x USB	836	TPR9-010
6 sockets + switch + 2 x USB	1400	TPR14-001
6 sockets + switch + fault current protection + 2 x USB	1400	TPR14-010
6 sockets + switch + 2 x USB	1700	TPR17-001
6 sockets + switch + fault current protection + 2 x USB	1700	TPR17-010

More information and images on power rails on page 86.



Power rails

Shelf for packing material SPM

Size W x D x H mm	Max load kg	Code
467 x 600 x 32	60	SPM500-49
717 x 600 x 32	60	SPM750-49
870 x 600 x 32	60	SPM900-49
1167 x 600 x 32	60	SPM1200-49
1317 x 600 x 32	60	SPM1350-49
1467 x 600 x 32	60	SPM1500-49
1773 x 600 x 32	60	SPM1800-49

The shelf does not include fastening parts.



Shelf for packing material, adjustable fastening set under worktop and divider hoops

Adjustable fastening set under worktop

Size W x D x H mm	Suitable for	Code
90 x 350 x 355	SPM-shelves	SPMAF-49

Free space 285-465 mm on lower shelf.



Adjustable fastening set under worktop

Divider hoops set (4 pcs)

Size W x D x H mm	Suitable for	Code
8 x 400 x 280	SPM-shelves	PDH600-49

Fixed tape dispenser

Suitable for	Code
Concept, TPB, TED	FTD50

Includes screws to fix the dispenser to ASSA4 (see page 58). Max roll Ø 120 mm and width 50 mm.



Fixed tape dispenser



Basic label dispenser

Basic label dispenser

Size W x D x H mm	Suitable for	Code
214 x 128 x 120	Concept, TPB, TED	BLD20

Can be fixed with screws. Max roll Ø 220 mm and width 210 mm.

+ Additional packing accessories on page 66.

Accessories that suit all benches

Note! Not suitable for Quick Edge

Equipment tray with bench top fixing

Size W x D x H mm	Max load kg	Suitable for	Code
250 x 250 x 90	5	all benches	860 885-49

Document holder A4 with bench top fixing

Size W x D x H mm	Max load kg	Suitable for	Code
290 x 330	5	all benches	860 882-49

Tool panel with bench top fixing

Size W x D x H mm	Max load kg	Suitable for	Code
267 x 305	5	all benches	860 883-49

Bin rail with bench top fixing

Size W x D x H mm	Max load kg	Suitable for	Code
315 x 72	5	all benches	860 884-49

Light arm, bench top fixing

Size W x D x H mm	Max load kg	Suitable for	Code
200	5	all benches	860 990-49

Bag holder for bench top lower edge

	Suitable for	Code
	all benches	860 840-49

Keyboard tray NT

Size W x D x H mm	Suitable for	Code
525 x 399 x 133 (outer)	WB and TP/TPH benches, SAP/WTR trolleys	NT 500 ESD
500 x 250 x 110 (inner)		

Recycling material bin PRMB3 with steel rails

Size W x D x H mm	Suitable for	Code
282 x 590 x 650	WB, Concept, TP, TPH and TPB	PRMB3

Tool holder box PPH

Size W x D x H mm	Suitable for	Code
400 x 300 x 140	all benches	PPH TXL

Keyboard tray (attached to the bench top)

Size W x D x H mm	Max load kg	Suitable for	Code
680 x 375 x 106 (outer)	10	all benches	925 49 001P
620 x 305 x 90 (inner)			



Equipment tray



Document holder



Tool panel



Bin rail



Light arm



Bag holder



Keyboard tray NT



Recycling material bin PRMB3



Tool holder box PPH



Keyboard tray (attached to the bench top)

ESD accessories

Earthing supplies

Name	Press button	Resistance	Code
Earthing box	3 x 10 mm	1 Mohm	J6603
Earth junction box, yellow. Cable 2 m.			860 522-00
Earthing cable, black, 1,5 m	10 mm / M5 terminal	1 Mohm	860 520-00
Earthing cable 5 m	10 mm		MK3040
Press stud	10 mm / female		PN3034



Earthing box



Earth junction box, yellow

Wrist straps

Name	Press button	Resistance	Code
Adjustable wrist strap	7 mm	1 Mohm	R2216
Metal wrist strap	7 mm	1 Mohm	R2206

Wrist strap set includes wrist band and coiled cord. Earth lead with 1 megaohm resistor, length 3,6 m. Includes 7 mm press stud for connection to wrist strap and 10 mm press stud for connection to earthing point.



Earthing cable, black



Earthing cable

ESD mats

Name	Size W x D mm	Code
ESD Ergo floor mat	950 x 650	852 880-00
ESD bench top mat*	1,22 x 10,00 m (12,20 m²)	PM157

*Resistant to heat, solder flux, most chemicals and solvents. The ESD mats are to EN 61340-5-1 standards. Abraded non slip underside. Does not contain PVC. Supplied by the metre or in rolls. Colour: platinum grey. Resistance surface to ground: $7,5 \times 10^5 - 10^7$ ohm.

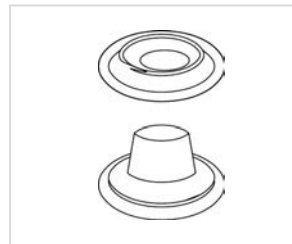

Press stud



Adjustable wrist strap



Metal wrist strap



ESD Ergo floor mat



ESD bench top mat

Treston power rails

New Treston power rails include USB-charging and also fault current protection is available in most of the standard rail lengths available from stock. Stock selection also includes three lengths with 2 x CAT6A data connectors. Also versions with other data and audio connectors and customised combinations of these are available on request.

Power rails come with brackets for fixing to Treston workstations. Rails can be fixed vertically on upright or aluminum profile, horizontally on aluminum profile or on M750 and M900 modules between uprights. With the new bracket set rails can also be fixed straight to the table top or perforated panel. A power rail can be mounted to four different angle on brackets. Length of rail can limit the mounting possibilities.



Ideal mounting for different lengths

Code	Length	Concept, Workshop, TP Uprights	WB Aluminum profile	TPH	TED
TPR3-	331	Vertical	Hor/Ver	On table top	Upright vertical
TPR4-	468	Vertical	Hor/Ver	On table top	On table top
TPR7-	683	M750 horizontal	Hor/Ver	On table top	M750
TPR9-	836	M900 horizontal	Hor/Ver	On table top	M900
TPR14-	1400	On table top	On table top	On table top	On table top
TPR17-	1700	On table top	On table top	On table top	On table top

Power rails

Description	Length	Code
1 3 sockets + 2 x USB	331	TPR3-001
2 6 sockets + switch + 2 x USB	468	TPR4-001
3 6 sockets + switch + 2 x USB + 2 x CAT6A	468	TPR4-003
4 4 sockets + switch + fault current protection	468	TPR4-004
5 6 sockets + switch	468	TPR4-005
6 5 sockets + switch + 2 x USB	683	TPR7-001
7 5 sockets + switch + 2 x USB + 2 x CAT6A	683	TPR7-003
8 4 sockets + switch + fault current protection + 2 x USB	683	TPR7-008
9 10 sockets + switch	683	TPR7-038
10 6 sockets + switch + 2 x USB	836	TPR9-001
11 6 sockets + switch + 2 x USB + 2 x CAT6A	836	TPR9-003
12 6 sockets + switch + fault current protection + 2 x USB	836	TPR9-010
13 6 sockets + switch + 2 x USB	1400	TPR14-001
14 6 sockets + switch + fault current protection + 2 x USB	1400	TPR14-010
13 6 sockets + switch + 2 x USB	1700	TPR17-001
14 6 sockets + switch + fault current protection + 2 x USB	1700	TPR17-010



Packing material roll stands and cutters

High packing material roll stand

Size W x D x H mm	Module	Max roll width mm	Code
1380 x 764 x 1640	M1350	1200	890 520-49P
1530 x 764 x 1640	M1500	1400	890 521-49P
1830 x 764 x 1640	M1800	1700	890 522-49P

High stand for two rolls. The rolls are adjustable in height. Axle diameter 25 mm. Max roll Ø 800 mm. Can be equipped with extra roll holder set, castor set and cutter PPC. Max load 40 kg per roll.



High packing material roll stand

Low packing material roll stand

Size W x D x H mm	Module	Max roll width mm	Code
1380 x 764 x 1000	M1350	1200	859 103-49P
1530 x 764 x 1000	M1500	1400	859 105-49P
1830 x 764 x 1000	M1800	1700	859 108-49P

Low stand for one roll. The roll is adjustable in height. Axle diameter 25 mm. Max roll Ø 800 mm. Can be equipped with extra roll holder set, castor set and cutter PPC. Max load 40 kg per roll.

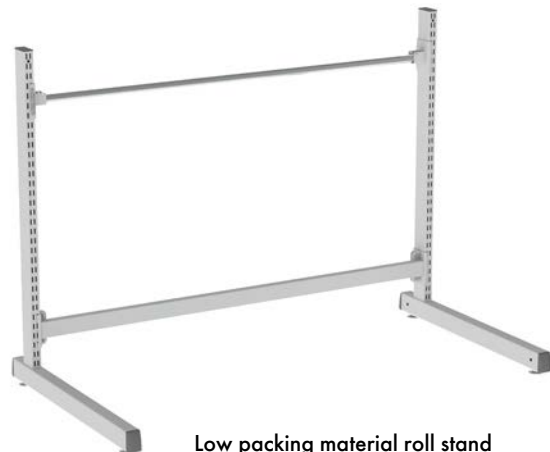

Low packing material roll stand

Castor set for packing material roll stands

Size mm	Code
Ø 100	LCS100

4 swivel castors Ø 100 mm, 2 with brakes. Attached directly to the stands.



Castor set for packing material roll stands

Extra roll holder set

Module	Max roll width mm	Code
M1350	1200	859 040-49P
M1500	1400	859 041-49P
M1800	1700	859 042-49P

Extra roll holder set for packing material roll stands. Including brackets. Axle diameter 25 mm, zinc electroplated. Max load 40 kg.



Extra roll holder set

Cutter PPC

Size W x D x H mm	Module	Cutting width mm	Code
1200 x 130 x 200	M1200	950	PPC120
1350 x 130 x 200	M1350	1110	PPC135
1485 x 130 x 200	M1500	1250	PPC150
1785 x 130 x 200	M1800	1550	PPC180

The round cutting knife will slice through paper and cardboard with ease. Can be affixed to the bench top or alternatively to the upright profiles with fixing brackets PPC FB.



Cutter PPC

Fixing brackets for cutter

Suitability	Code
All benches	PPC FB

In order to obtain an ergonomic position, the cutters can also be affixed to the upright profiles of all the workbenches using these fixing brackets. The fixing brackets make the cutter both height and tilt adjustable, tilt 30 degrees. Cutter is ordered separately.



Fixing brackets for cutter

Bracket pair for cutter

Suitability	Code
Packing material roll stands	890 511-49P

Cutter PPC can be fitted to the packing material roll stand with the bracket pair. Height adjustable. Cutter is ordered separately.



Bracket pair for cutter





3. Lighting

TRESTON

TRE

Lighting ergonomics



Lighting is a vital part of ergonomic workspaces in industrial environments. Light allows people to see and perform tasks better and it affects their personal wellbeing and health.

Individually adjustable, natural workstation lighting means more productivity

Investing in individually controllable task lighting on workstations benefits both the employees and the employer. Employees feel more motivated as they can adjust brightness and preferably also colour tone to best suit themselves and the task at hand. This can lead to increased productivity, reduced errors and less absence, which normally affect the company's profitability.

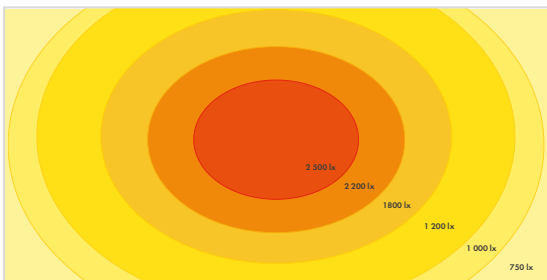

Graph of light Illuminance

Treston NaturLite LED 1200 Illuminance $\pm 10\%$ (@1 meter)

Lighting standard sets the expectations

When designing workstations and their lighting, we observe the recommendations of the EN 124641 standard on indoor workplace lighting. The illuminance levels set by standards are average values, but going beyond those is often reasonable. It is especially beneficial to increase the high-quality lighting for employees over 45 years old.

Optical ergonomics need attention

Optical ergonomics require the viewed object to be at a suitable distance and location, in order to maintain an acceptable amount of eye movement and ensure that the details can be seen without problems. Also, adequate and glare-free lighting is important. When these conditions apply and the working position is well adjusted, saving time and money due to fewer absences and decreased stress can be expected.

Benefits of proper adjustable lighting in industrial environments include

- Reduced number of errors
- Decreased absenteeism
- Increased well-being of the employees
- Increased productivity

Treston NaturLite LED: Natural workstation lighting for industrial environments



Good, adjustable workstation lighting is essential for work quality and the well-being of employees. The right amount of light at the right time also enhances productivity and reduces errors in industrial environments.

Achieve your full potential with:

- Tunable colour tone
- Dimmable brightness
- Effective performance



Get all the specifications
and download the brochure



treston.com/catalogues-and-brochures

Treston NaturLite LED Plus 1200



Adjusting colour temperature can have a positive effect on employee productivity and well-being. Beneficial also in environments where it is important to see objects in different light ranges.

Convenient to use with
a mobile app or a remote control.

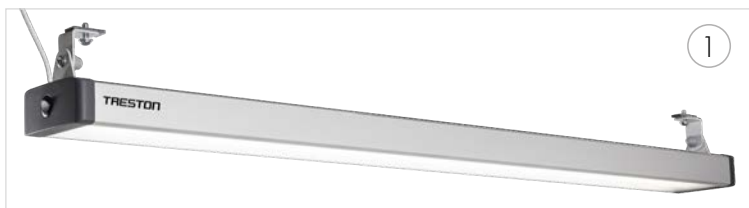

Treston NaturLite LED Plus 1200
Light with tunable colour tone



Treston NaturLite LED 900
Dimmable light for smaller tables

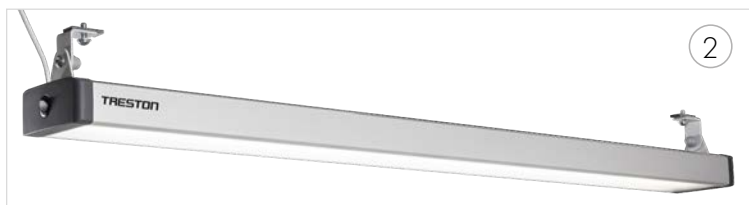

Treston NaturLite LED 1200
Dimmable light for wider tables



Treston NaturLite LED Wing 500
Versatile task light with dimming

Name	Control	Colour temperature	Illuminance ±10% (@1 meter)	Luminous flux	Power	Size W x D x H mm	Suitability	Code
1. Treston NaturLite LED Plus 1200	Controlled via mobile app or separate remote control + ON/OFF button in the luminaire body	2700 - 6500 K	@4000 K: 2800 lx (1000 - 2800 lx depending on the colour temperature)	3200-6300 lm (depending on the selected colour temperature)	60 W	1180 x 120 x 50	All Treston and various other industrial workbenches	TNL1200P
Remote control for Treston NaturLite LED Plus 1200	Easy to use and save presets via mobile app. White.					90 x 90 x 12	Treston NaturLite LED Plus 1200	TNLPR
2. Treston NaturLite LED 1200	Touch dim button switch for ON/OFF and dimming in the luminaire body	4000 K	3100 lx	7100 lm	56 W	1180 x 120 x 50	All Treston and various other industrial workbenches	TNL1200
3. Treston NaturLite LED 900	Touch dim button switch for ON/OFF and dimming in the luminaire body	4000 K	2300 lx	5200 lm	42 W	900 x 120 x 50	All Treston and various other industrial workbenches	TNL900
4. Treston NaturLite LED Wing 500	Touch dim button switch for ON/OFF and dimming in the luminaire body	4000 K	800 lx	1750 lm	14 W	430 x 120 x 50 mm (+ bracket 95/120 mm)	Concept, WB, TED and TP benches, Treston Tower, TPH and TPB benches*	TNL500W

Common features: Dimmable, Lifetime > 50 000 hours (L90B10), Color Rendering Index CRI > 80, High quality LED (MacAdams < 3) Aluminium body, 2 years guarantee, Enclosure protection IP20

* TPH and TPB benches require bracket 890 683-49



Watch this animation and get the main facts of the Treston NaturLite LED lights in less than 2 minutes: <https://vimeo.com/241502723>



Cutting edge technology

- Tunable colour tone (2700-6500 K)
- Power 14-60 W (max)
- Illuminance 800-3100 lx \pm 10 % (1 meter)
- Lifetime > 50 000 hours (L90B10)
- Color Rendering Index CRI > 80
- High quality LED (MacAdams < 3)
- Dimmable 1/10-100%
- Lean design
- 2 years guarantee
- Suitable for all Treston and various other industrial workbenches
- Enclosure protection IP20



- ✓ Adjustability helps to find optimal lighting conditions.
- ✓ Timeless design brings functional beauty to industrial environments and it is never out of style.
- ✓ Easy and fast to install – just click, slide and screw.
- ✓ High-quality LED lights with high-quality drivers are care-free for years to come. Low maintenance, just keep them clean!
- ✓ Designed and manufactured in Finland.



Treston NaturLite LED Wing 500

- Versatile task light
- Working area with or without shadows
- Also suitable in the middle of the table

Optimal light for industrial environments: Treston IntoLite LED



- ✓ Good quality, bright and long lasting light.
- ✓ Light with basic features and capability to give optimal light to workstation.

Name	Control	Colour temperature	Illuminance ±10% (@1 meter)	Luminous flux	Power	Size W x D x H mm	Suitability	Code
Treston IntoLite LED	Touch button switch for ON/OFF	4000K	1800 lux ±10%	3800 lm	36W	850 x 67 x 80	All Treston and various other industrial workbenches	TIL850

Common features: Lifetime > 50 000 hours (L70B10), 2 years guarantee, Enclosure protection IP20

Compatibility with light and balancer rails

	Module / suitable for	Front profile width mm	Code	Compatible lighting units
Light and balancer rail (Concept, TED, Quick Edge, TP and Workshop benches)	2 x M500	1000	91849001P	TNL900, TIL850
	2 x M500/1500	1500	91849002P	TNL900, TNL1200, TNL1200P, TIL850
	4 x M500	2000	91849003P	TNL900, TNL1200, TNL1200P, TIL850
	M750	750	91849004P	-
	M750/900	900	91849013P	TNL900, TIL850
	M750/1500	1500	91849005P	TNL900, TNL1200, TNL1200P, TIL850
	2 x M750	1500	91849006P	TNL900, TNL1200, TNL1200P, TIL850
	3 x M750	2250	91849012P	TNL900, TNL1200, TNL1200P, TIL850
	M900	900	91849007P	TNL900, TIL850
	2 x M900	1800	91849008P	TNL900, TNL1200, TNL1200P, TIL850
	M900/1500	1500	91849009P	TNL900, TNL1200, TNL1200P, TIL850
	M1200	1200	91849010P	TNL900, TNL1200, TNL1200P, TIL850
	M1350	1350	91849011P	TNL900, TNL1200, TNL1200P, TIL850
Support bracket HSB (WB benches)	AL2X110W	1073	HSB110	TNL900, TIL850
	AL2X150W	1500	HSB150	TNL900, TNL1200, TNL1200P, TIL850
	AL2X180W	1800	HSB180	TNL900, TNL1200, TNL1200P, TIL850
Tool and lighting support KT (TPH and TPB benches)	TPH712	1200	KT120	TNL900, TNL1200, TNL1200P, TIL850
	TPH715/915, TPB915	1500	KT150	TNL900, TNL1200, TNL1200P, TIL850
	TPH718/918, TPB918	1800	KT180	TNL900, TNL1200, TNL1200P, TIL850

Magnifying lamp

Treston Wave LED ESD



- ✓ Lamp can be easily adjusted to desired position thanks to very precise and flexible 3-joint arm.
- ✓ Lamp offers shadow-free magnification with light coming from both sides.
- ✓ Wave LED ESD is suitable for use in EPA-areas.
- ✓ Suitable for all Treston Workbenches and other manufacturers' workbenches

Name	Control	Colour temperature	Illuminance ±10% (@1 meter)	Luminous flux	Power	Size W x D x H mm	Fixing	Code
Treston Wave LED ESD	2-sided touch button with 4 level dimming	4000K	1500 lx	764 lm	13W	Lamp 227 x 225 x 40 mm, 3-joint arm length 500 + 550 mm	Table clamp (max thickness 72 mm)	TWL ESD

Common features: Lifetime > 50 000 hours, 5 years guarantee, Enclosure protection IP20. Power cord 1,7m with Schuko-plug CEE7/7.



4. Chairs

High-performance industrial chairs with a 10 year warranty



The new Treston chair range offers high-performance seating solutions with maximum customer benefit for any industrial and technical working environment. Our high-quality technical products fulfill the highest requirements, offer outstanding value for money and meet the requirements of various workplaces – from production and packaging to standing work, ESD areas and R&D environments.

Industrial workplaces require industrial chairs

An ergonomically sound chair is a vital part of the well-functioning, ergonomic and user-friendly workstation. Good sitting enables effective and appropriate movements, reduces postural fixity and enables good and relaxed working postures. The ergonomic requirements of workplace chairs in industrial and technical environments are inherently different to those of other areas, such as office. The jobs carried out at manufacturing workstations may involve force, precision skills and repetitive movements, and thus the workplace chair must adapt perfectly to these tasks and working environments in order to support the workers – and their well-being- in the best possible way.

Six models with 24 variations

The new chair range consists of six different models: Multi-purpose Treston Ergo, Treston Plus with an all-inclusive ergonomic package, new generation workplace chair Neon with changeable upholsteries, Flex for standing work, Stool for assistance in workshops and Saddle chair for alternative way of sitting. In addition, there are three surfaces/upholsteries to choose from: a highly resistant polyurethane, comfortable fabric and easy-to-care artificial leather, making it is easy to find the most suitable chair for the working environment from our 24 chair variations.

Safe, sound and economic solution

Treston chairs ensure safety in the workplace by fulfilling the requirements of DIN 68877 and by carrying the GS safety mark, and in addition, our ESD chairs are in compliance with EN 61340-5-1. Besides being safe and ergonomic, our chair selection has a full 10 year warranty*. The Treston chair range is a safe, sustainable and economic solution for industrial seating.

* Saddle chairs 2 years



treston.com/catalogues-and-brochures

**READ MORE ABOUT
ergonomic sitting from our
separate brochure!**



Treston Ergo

Multipurpose chair for almost any application in the industry

- User-friendly and quick adjustability
- Excellent price-performance ratio
- Large, ergonomically designed seat and backrest and lumbar support



Treston Plus

The all-inclusive ergonomic package

- Best possible adjustment to body size
- Supports the body in every position
- For any work situation



Neon

New generation workplace chair

- All the same adjustments and features as in Treston Plus
- In addition changeable upholstery and flex strip for protection of the chair and its environment



Flex standing rest

For best support in standing work and combined workplaces

- 360° rotation of the seat, easy height adjustment of foot ring
- Space saving
- Slip resistant seat



Stools

- Optimal assistance in workshop and heavy duty applications
- Adjustment for seat height



Saddle chairs

- Freedom of movement with ergonomic sitting position
- Adjustment for seat height and seat tilt



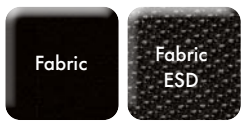

Treston Ergo chair with fabric upholstery

	Treston Ergo 30	Treston Ergo 30 ESD	Treston Ergo 35	Treston Ergo 35 ESD
Description	With soft dual-wheel safety castors (conductive with ESD versions) with load-sensitive brakes.		High version with foot ring and glides (conductive with ESD versions).	
Upholstery	The high-quality fabric upholstery is breathable and can both absorb and expel moisture.			
Code	C30BL	C30BL-ESD	C35BL	C35BL-ESD



Treston Ergo chair with artificial leather upholstery

	Treston Ergo 30 AL	Treston Ergo 30 AL ESD
Description	With soft dual-wheel safety castors (conductive with ESD versions) with load-sensitive brakes.	
Upholstery	Artificial leather upholstery is washable, resistant to disinfectants and easy to care.	
Code	C30AL	C30AL-ESD



Treston Ergo chair with polyurethane foam (PU)

	Treston Ergo 20 PU	Treston Ergo 20 PU ESD	Treston Ergo 25 PU	Treston Ergo 25 PU ESD
Description	With soft dual-wheel safety castors (conductive with ESD versions) with load-sensitive brakes.		High version with foot ring and glides (conductive with ESD versions).	
Upholstery	The PU surface is highly resistant, extremely robust, washable and very easy to clean.			
Code	C20PU	C20PU-ESD	C25PU	C25PU-ESD



Treston Plus chair with fabric or artificial leather upholstery

	Treston Plus 40 BL	Treston Plus 40 BL ESD	Treston Plus 40 AL	Treston Plus 40 AL ESD
Description	With soft dual-wheel safety castors (conductive with ESD versions) with load-sensitive brakes			
Upholstery	Black fabric	Black fabric ESD	Artificial leather	Artificial leather ESD
Code	C40BL	C40BL-ESD	C40AL	C40AL-ESD



Neon chair with fabric upholstery

	Neon 50 ESD
Description	With conductive soft dual-wheel safety castors with load-sensitive brakes.
Upholstery	Black fabric ESD, grey flex strip
Code	C50BL-G-ESD



Flex standing rest with polyurethane foam (PU)

	Flex 19	Flex 19 ESD
Description	High version with foot ring and glides (conductive with ESD versions).	
Upholstery	The PU surface is highly resistant, extremely robust, washable and very easy to clean.	
Code	C19PU	C19PU-ESD



Stool with polyurethane foam (PU) or artificial leather

	Stool PU	Stool AL-ESD
Description	With soft dual-wheel safety castors (conductive with ESD versions) with load-sensitive brakes	
Upholstery	Polyurethane PU	Artificial leather ESD
Code	C15PU	C15AL-ESD



Saddle chair with fabric or (artificial) leather upholstery

	Saddle B	Saddle G ESD	Saddle AL ESD	Saddle L
Description	With soft dual-wheel safety castors (conductive with ESD versions) with load-sensitive brakes			
Upholstery	Blue fabric	Grey fabric ESD	Artificial leather ESD	Leather
Code	SADDLE B	SADDLE G ESD	SADDLE AL ESD	SADDLE L

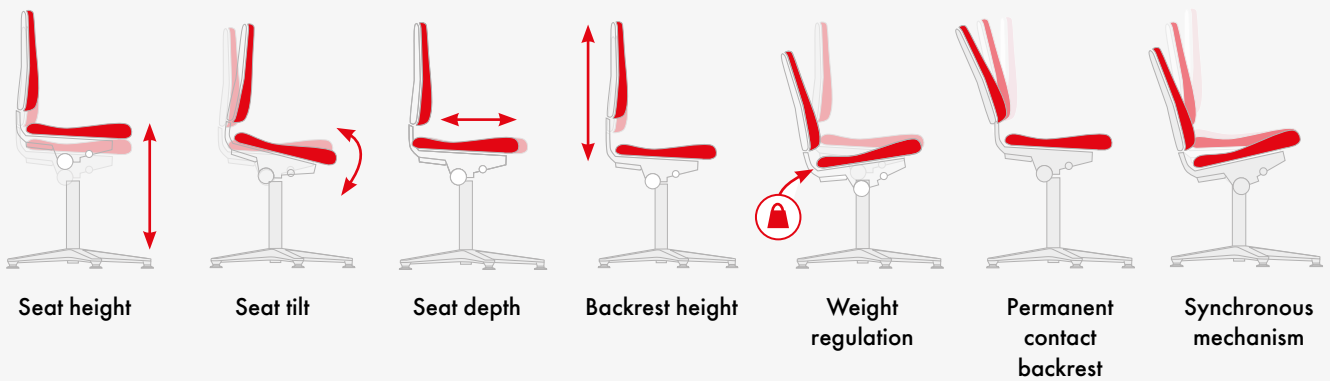

Adjustments and features	Treston Ergo	Treston Plus	Neon	Stool	Saddle chair	Flex – standing rest
Seat height	✓	✓	✓	✓	✓	✓
Seat tilt	✓	✓	✓		✓	
Seat depth		✓	✓			
Backrest height	✓	✓	✓			
Contact backrest	✓					
Synchro mechanism		✓	✓			
Arm rests as an option	✓	✓	✓			
Changeable upholstery			✓			

Code	Description / Upholstery / Colour	Martindale	Seat height, mm*	Seat width, mm	Seat depth, mm	Backrest height, mm	Weight, kg
Stools							
C15PU	Stool 15 polyurethane black		460-630	350	350		7,0
C15AL-ESD	Stool 15 artificial leather black ESD	50.000	460-630	400	400		8,0
Flex standing rests							
C19PU	Flex 19 polyurethane black		510-780	360	380	200	13,0
C19PU-ESD	Flex 19 polyurethane black ESD		510-780	360	380	200	13,0
Treston Ergo chairs							
C20PU	Treston Ergo 20 polyurethane black		440-620	440	410	380	11,5
C20PU-ESD	Treston Ergo 20 polyurethane black ESD		440-620	440	410	380	13,0
C25PU	Treston Ergo 25 polyurethane black		580-850	440	410	380	13,5
C25PU-ESD	Treston Ergo 25 polyurethane black ESD		580-850	440	410	380	15,0
C30AL	Treston Ergo 30 artificial leather black	50.000	440-620	460	470	460	12,0
C30AL-ESD	Treston Ergo 30 artificial leather black ESD	50.000	440-620	460	470	460	13,0
C30BL	Treston Ergo 30 fabric black	50.000	440-620	460	470	460	12,0
C30BL-ESD	Treston Ergo 30 fabric black ESD	40.000	440-620	460	470	460	13,0
C35BL	Treston Ergo 35 fabric black	50.000	580-850	460	470	460	14,0
C35BL-ESD	Treston Ergo 35 fabric black ESD	40.000	530-800	460	470	460	15,0
Treston Plus chairs							
C40AL	Treston Plus 40 artificial leather black	50.000	450-600	460	410-470	600	18,5
C40AL-ESD	Treston Plus 40 artificial leather black ESD	50.000	450-600	460	410-470	600	19,5
C40BL	Treston Plus 40 fabric black	50.000	450-600	460	410-470	600	18,5
C40BL-ESD	Treston Plus 40 fabric black ESD	40.000	450-600	460	410-470	600	19,5
Neon chairs							
C50BL-G-ESD	Neon 50 fabric black ESD grey strips	40.000	450-620	470	420-480	570	18,0
Saddle chairs							
SADDLE B	Saddle chair fabric blue	> 50.000	575-820	420	350		7,0
SADDLE G ESD	Saddle chair fabric grey ESD	> 50.000	575-820	420	350		7,0
SADDLE AL ESD	Saddle chair artificial leather ESD black		575-820	420	350		7,0
SADDLE L	Saddle chair leather black		575-820	420	350		7,0

* According to the DIN 68877, the seat height is measured from the floor to the centre of the seat with a 64-kg load. The maximum load capacity of the chairs is 120 kg.

Accessories for chairs

Product	Description	Code	Code ESD
High glide set	Abrasion-resistant plastic glides have a large surface area and offer superb level of stability. The glides can be retrofitted to all our chairs.	CGLIH	CGLIH-ESD
Soft castor set for hard floor	Dual-wheel safety castors are equipped with load-sensitive brakes, which means that the castors will brake when unloaded. As a standard, we supply soft castors for hard floors, but hard castors for soft floors need to be ordered separately.	CSCAS	CSCAS-ESD
Hard castor set for soft floor		CHCAS	CHCAS-ESD
Soft Stop&Go castor set for hard floors	In case the high chair needs to be moved around the workplace, Stop&Go castors will provide a safe solution. These castors will brake as soon as they are loaded, but when not loaded, the chair is easy to move around.	CSTOP	CSTOP-ESD
4D armrests for Treston Ergo and Treston Plus	Adjustment of height, width and depth with the possibility to swivel.	ARE	
4D ESD armrests for Treston Ergo ESD and Treston Plus ESD	Adjustment of height, width and depth with the possibility to swivel.		ARE-ESD
4D armrests for Neon	Adjustment of height, width and depth with the possibility to swivel.		ARN-ESD
Chrome-plated foot ring	Foot ring can also be retrofitted to our lower chair models by attaching it to the chair column. Can be used on both ESD and non-ESD models. The height can be easily adjusted without any tools.	CRING	CRING

5. Trolleys



Work smarter, not harder

Freedom of mobility with trolleys



Work is not always confined to a single workstation and tools must be moved around accordingly. Lightweight trolleys are ideal for this situation, significantly increasing productivity up to 30%.

The trolleys provide extra work or storage space and can be used, for example, to transport various items, to store measuring units and keep a buffer stock on a production line.

Each task is different and requires dedicated tools. Due to their modularity and versatile accessory components, trolleys are easy to design and adapt to suit a multitude of users and applications.



Watch this video: "How to choose an ergonomic trolley for industrial tasks" <https://vimeo.com/504278340>



Ergonomics for manual handling of loads

Manual handling of loads (also known as MMH – manual materials handling) means moving or handling things by lifting, lowering, pushing, pulling, carrying, holding, or restraining. Manual handling of loads is generally considered to be an occupational risk factor for low back and shoulder complaints and it is in fact the most common cause of occupational fatigue, low back pain and lower back injuries. Therefore, it should not come as a surprise that paying attention to ergonomics for manual handling of loads is extremely important for the safety and health of the workers as well as for the efficiency and productivity of the processes.

Pushing and pulling from an ergonomics viewpoint

Pushing and pulling are the two physical tasks most commonly related to working on and operating trolleys. The most common risk factors, related to pushing and pulling tasks, which could hinder the ergonomics, are forceful pushing/pulling, trolley design that does not promote neutral body postures, wrong direction of exerted forces (e.g. pulling when you should be pushing), one handed pushing or pulling, too heavy loads and wrong handle height.

A task suitable trolley that adapts to the size of the user is the answer to reducing the risk of work related musculoskeletal disorders (WMSD), especially for lower back, knee and shoulder injuries. When selecting a trolley for the task, you should always consider the human body power zones, where people have the greatest strength and most comfort working. See the image on the right as a reference. Trolley design should ensure that pushing and pulling can be done from the optimal height, between the knuckle and shoulder height of the worker, with the arms as close to the body as possible. Working in your power zone reduces the start force needed for pushing and pulling, reduces the effort and force needed to perform work tasks, and reduces the stress on your back and shoulders.

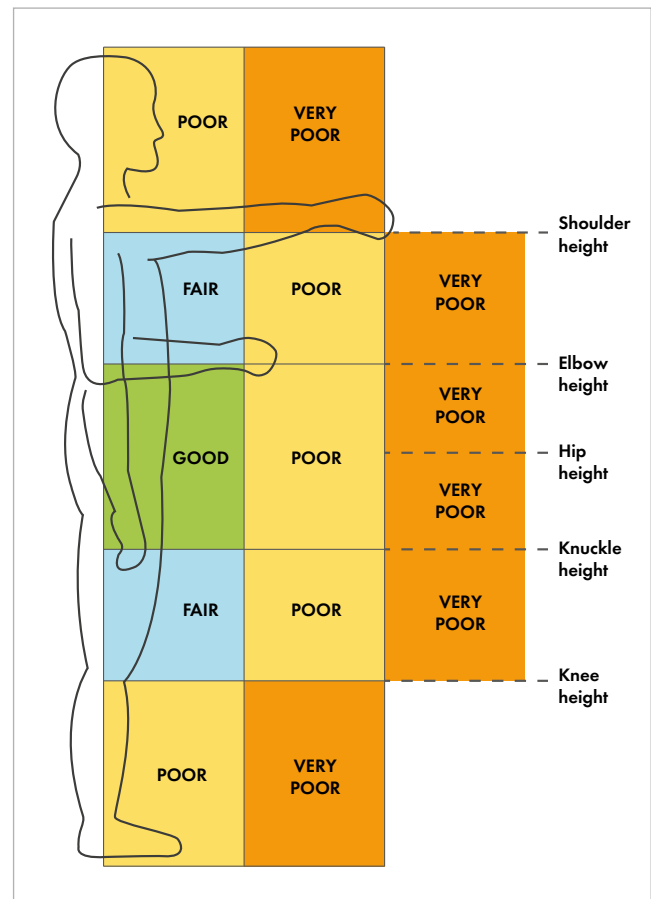
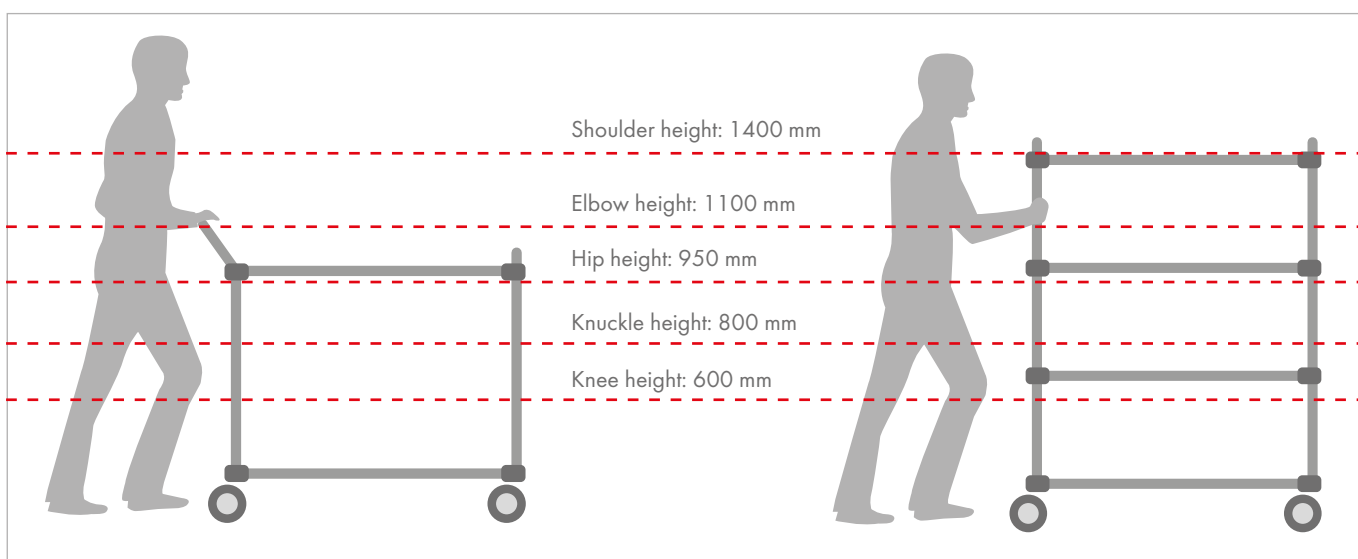

Illustration on the power zones where people have the greatest strength and most comfort, in regards of lifting and placing loads, pushing and pulling (i.e. above the knees, below the shoulders, and close to the body).

Consider the handle position and design

Vertical handles are considered the most optimal, as every sized worker is able to grasp the handles in their unique power zone. Handles can be horizontal as well, as long as they are the correct height for the user. Preferred handle height is between the shoulder and knuckle height of the worker, optimising the force applied for pushing and pulling.

The optimal shape for handles is cylindrical and smooth, which allows the best power grip with straight wrists. The handle diameter should be big enough to enable power grip instead of pinch grip. Power grip provides up to 75% more strength compared to pinch grip. Power grip involves grasping the handle by wrapping all the fingers around it, instead of grasping with thumb and tips of the other fingers.



Elbow height is the optimal position in regard to push forces. Displayed heights are indicative for average sized male.

CHANGE IN THE NATURE OF MANUAL LOAD HANDLING TASKS

In the past decades, industrial workspaces have been mostly redesigned so that carrying objects has been replaced by transporting objects by pushing or pulling them in trolleys, carts, hand pallet trucks and such. For example, in the automotive supply sector about 10% of all working processes involve pushing and pulling on a regular and repetitive basis.

In addition, the rapid growth of the e-commerce sector has increased the number of distribution centres worldwide. The primary job at these distribution centres is order picking and delivery, where manual handling aids such as carts, trolleys, hand pallet trucks and such are used to perform the tasks. The use of these aids has again eliminated carrying objects, changing the nature of manual load handling tasks predominantly to pushing and pulling.

In general, it has been estimated that nearly half of common manual load handling tasks in workplaces consist of pushing and pulling exertions performed on level surfaces and variable inclined ramps.

Castors play an important role

A quality castor is of the appropriate size in relation to the working environment and purpose of the trolley. The bigger the castor, the easier it is to move the trolley. For example, big castors make it easier to push the trolley over thresholds and other similar obstacles. The tread in quality castors withstands wear and tear. The wheel/tread material is not the only factor influencing the usability and easy movability of the trolley, as the flooring material also affects how well the castor rolls and moves.

Swivel castors are also handy on a trolley, making it easy to manoeuvre even in small spaces. We recommend using



four swivel castors in tight spaces, making it easier to turn and control loads. Strong castor brakes lock the trolley in position, making sure that it stays where it is supposed to be.

Castors have a big effect in minimizing the start forces needed to get the trolley moving as well as in reducing the rolling resistance and therefore play an important role in ensuring proper ergonomics. The amount of force required to move loads with trolleys depends on a number of factors:

- weight and shape of the load
- type and condition of floor surface (e.g. smoothness and density)
- route taken (e.g. slopes and obstacles)
- type of castor, especially the materials used
- size of castor
- maintenance of castors – cleaning, lubricating and/or replacing castors on a regular basis has a vital effect in maintaining the ride comfort and minimizing the push effort.

Task experience is the key to reducing strain

Task experience and correct working technique in pushing and pulling play an important role in reducing some measures of biomechanical strain and therefore yield potential for reducing the risk of injury. For example, pulling a lighter weight trolley at hip height, with arms outstretched, would result in very high compressive force at the lower back, as opposed to pushing a much heavier trolley between shoulder and elbow height, arms closer to body, which results in much less of a compressive force at the lower back. As a reference, see the illustration on the power zones where people have the greatest strength and most comfort.

If your goal is to ensure efficient processes and ergonomic working conditions, start by selecting the correct type of trolley for the task and then orientating all workers with the physical aspects and best working techniques for the specific task at hand. No matter how fancy the features of your trolley, if your workers use bad techniques while performing their tasks with the trolley, you are sure to increase the risk of injuries and create inefficiency in processes. If necessary, modify work practices so that workers can perform their tasks and work within their power zone.



Although there is no exact weight limit that is safe, a weight of 20–25 kg is heavy to lift for most people and it thus increases the risk of back injury.



What to consider when selecting a trolley?

Selecting the right trolley is not complicated, but there are certain considerations to take into account to ensure you get the best possible trolley for your needs.

1. **Why do you need the trolley?** What is its purpose? Are flexibility and easy reconfiguration important features of the trolley? If you have a fixed task and fixed need for the trolley, a specific trolley for that need will most likely be the best solution for you. But if you need a trolley that can be easily adapted to changing needs and production processes, choose a trolley that has a modular structure, a wide range of accessories, and good ergonomics, which will help you flexibly adapt the trolley to a multitude of tasks.
2. **What are the objects being handled on the trolley?** Are you moving lightweight boxes of the same size and weight or bulky equipment that can differ in size and weight? The weight and shape of the objects handled determine the load capacity and shelf and work surface size of your trolley. If the size of handled objects varies, select a height adjustable work surface and/or shelves to ensure proper ergonomics no matter what size of objects you handle. Tilted shelves improve access and handling of objects, as it enables you to work from your power zone.
3. **How are the objects handled?** Are they sorted or unsorted? Can you stack them or are they loose? Especially for unsorted and loose objects, it is better to equip the trolley shelves with edges and/or rubber mats, to ensure the goods do not fall over when moving. Remember though that shelves with edges make it more difficult to handle, lift and lay down heavy objects. Another possibility is to use a caged trolley, where the side walls of the trolley are at least partially closed in order to help keep objects in place. Mesh panels are a good option for this: they allow visual inspection and keep the construction light.
4. **What kind of working environment is it?** Do you have to enter doors with the trolley? How wide are the walkway spaces? If you have to move through doors in different workspaces and/or long distances within the space, check the walkway and door widths to ensure sufficient space.
5. **What type of castors should I have?** A quality castor is of the appropriate size in relation to the working environment and purpose of the trolley. Castors have a big effect in minimizing the start forces needed to get the trolley moving as well as in reducing the rolling resistance and therefore play an important role in ensuring proper ergonomics.
6. **How about handles?** Trolleys that are moved around a lot and transported for longer distances should be equipped with at least one handle, to make handling, pushing and pulling easy, effortless and ergonomic. Vertical handles are considered the most optimal, as every sized worker is able to grasp the handles in their unique power zone. Preferred handle height is between the shoulder and knuckle height of the worker, optimizing the force applied for pushing and pulling. The optimal shape for handles is cylindrical and smooth, which allows the best power grip with straight wrists.
7. **How often is the trolley used?** If you have a trolley in active everyday use, invest in a high quality, reliable and durable trolley with high quality castors. This might be a more expensive initial investment, but in the long run a high quality trolley will pay for itself with its long lifetime and flexibility in use.
8. **Consult the people using the trolley in their work.** They have the best hands-on experience and can give valuable input on the required features, such as size and load capacity, as well as on the accessories needed to perform the work ergonomically and efficiently. Knowing your loads helps you to buy equipment of appropriate capacity.
9. **How ergonomic is the trolley?** As a quick ergonomics check, make sure the handles, work surfaces, and accessories are easily height adjustable to adjust to the worker and task at hand to ensure proper ergonomics. If your goal is to ensure efficient processes and ergonomic working conditions, start by selecting the correct type of trolley for the task and then orientating all workers with the physical aspects and best working techniques for the specific task at hand. No matter how fancy the features of your trolley, if your workers use bad techniques while performing their tasks with the trolley, you are sure to increase the risk of injuries and create inefficiency in processes.



150 kg



300 kg



150 / 300 kg

**Universal trolley WTR,
page 112**

Most often combined with WB workstations to provide extra storage space. A good adjustable PC station, measuring station or mobile storage, best suitable for moving equipment around the workstation.

**Industrial Multi trolley,
page 113**

This trolley can be equipped with shelves, tops and other module-sized accessories to fit any application, such as transportation or tool storage. The trolleys support heavy loads, but they are easy to move as well.

**Adjustable trolley TRTA,
page 116**

For general use wherever a good transportation and storage solution is needed. Two or four shelves available; height of the shelves can be adjusted. Mesh panels can be installed at the ends or on the sides. Also a SMD reel holder version available.



12 / 25 kg



90 kg



150 kg



150 kg

**Mobile workstations,
page 118**

A light, ergonomic and easy-to-move workstation. The mobile workstation moves and turns effortlessly even in tight spaces. Used wherever a laptop is needed on the go.

**Trolleys for additional workspace,
page 119**

Additional worktop space is often needed in workspaces. Equipped with castors, they can be moved around easily and can also be used to transport supplies. The product family includes many models for different purposes.



150 kg

Packing trolleys, page 120

Handy trolleys designed with packing in mind provide space to keep boxes and other materials within arm's reach, but they also can be moved aside as needed.



600 kg

Heavy-duty trolley, page 122

Heavy-duty trolleys, as their name indicates, are ideal for moving heavy loads. Their special castors support extremely heavy weights.



300 kg

Fitter's trolley, page 123

A fitter's trolley lets you take your supplies and tools wherever you go, while keeping them organised. Rubber mats and ESD-mats for shelves available separately.



300 kg

Tool trolley, page 124

Sturdy tool trolley for workshop and garage environment. Tool trolley is very practical working surface with drawers and cabinets to store tools and components. Several combinations available.



300 kg

Service trolley, page 126

The service trolley frame is equipped with a safety locking feature that allows only one drawer to be opened at a time.



300 kg

Bin and cabinet trolleys, page 128

The bin and cabinet trolleys can be equipped with Treston stacking bins and bin cabinets based on own needs. Trolleys enable supplies and parts to be moved smoothly to wherever they are needed.

Universal trolley WTR

A good quality, versatile trolley, PC-station, measuring station or mobile storage trolley. Modern industrial design.

The standard trolley has 3 shelves (TS 605), size 650 x 530 mm. Height adjustment of shelves is by allen-key. The vertical profiles are of aluminium. Frames are of epoxy powder coated steel: light grey RAL 7035. The worktops are of 25 mm laminated particle board. Four swivel castors (Ø 125 mm) two of which have brakes, overall height of castor 141 mm.



Universal trolley WTR

Name	Size W x D x H mm	Max load kg	Code	Code ESD
1. Universal trolley	660 x 650 x 1415	150	WTR140	WTR140 ESD
2. Extra shelf	530 x 650	50	TS605	TS605 ESD
3. Adjustable shelf*	530 x 650	50	TAS605	TAS605 ESD
4. Bin profile	Length 525		BP50	BP50 ESD
5. Power rail	Length 468 mm		TPR4-001	
6. Keyboard tray NT	525 x 399 x 133 (outer) 500 x 250 x 110 (inner)		-	NT 500 ESD

*Continuous adjustment for depth, height and angle.



Treston Industrial Multi trolley

Multi trolleys provide an ergonomic mobile workstation. Multi trolleys are available in three different widths: M500, M750 and M900. This means that all our module-sized accessories can be used with the trolleys.

The sturdy shelves can be height-adjusted and tilted. Shelves come with raised edges which keep the load in place. Rubber mats and ESD-mats for shelves available separately.

Multi trolleys support heavy loads, but they are easy to move as well, making it simple to transport heavy equipment, such as measuring units. They are equipped with four swivel castors (Ø 125 mm), two of which have brakes.

Treston Industrial Multi trolley with adjustable shelves

Description	Module	Size W x D x H mm	Max load kg	Code	Code ESD
1. 4 adjustable shelves	M500	540 x 760 x 1790	300	TMTH5-002-41	TMTH5-002-49
	M750	790 x 760 x 1790	300	TMTH7-002-41	TMTH7-002-49
	M900	943 x 760 x 1790	300	TMTH9-002-41	TMTH9-002-49
2. 2 adjustable shelves	M500	540 x 760 x 1150	300	TMTL5-002-41	TMTL5-002-49
	M750	790 x 760 x 1150	300	TMTL7-002-41	TMTL7-002-49
	M900	943 x 760 x 1150	300	TMTL9-002-41	TMTL9-002-49

Bottom shelf and mats for shelves, see page 115.



Treston Industrial Multi trolley with shelves

Description	Module	Size W x D x H mm	Max load kg	Code	Code ESD
3. 4 shelves	M500	540 x 760 x 1790	300	TMTH5-001-41	TMTH5-001-49
	M750	790 x 760 x 1790	300	TMTH7-001-41	TMTH7-001-49
	M900	943 x 760 x 1790	300	TMTH9-001-41	TMTH9-001-49
4. 2 shelves	M500	540 x 760 x 1150	300	TMTL5-001-41	TMTL5-001-49
	M750	790 x 760 x 1150	300	TMTL7-001-41	TMTL7-001-49
	M900	943 x 760 x 1150	300	TMTL9-001-41	TMTL9-001-49

Bottom shelf and mats for shelves, see page 115.



1. Treston Industrial Multi trolley with perforated panels

Module	Size W x D x H mm	Max load kg	Code	Code ESD
M750	790 x 760 x 1790	300	TMTH7-005-07	TMTH7-005-49
M900	943 x 760 x 1790	300	TMTH9-005-07	TMTH9-005-49

2. Treston Industrial Multi trolley with tilted perforated panels

Module	Size W x D x H mm	Max load kg	Code	Code ESD
-	820 x 760 x 1860	300	TMTA-41	TMTA-49

3. Treston Industrial Multi trolley with perforated tool cabinet

Module	Size W x D x H mm	Max load kg	Code
M750	790 x 760 x 1790	300	TMTH7-104-07



Industrial Multi trolley frame and accessories

- Equip your trolleys with shelves, tops and other accessories to fit any application, such as transportation or tool storage.
- All trolleys are equipped with four swivel castors (Ø 125 mm), two of which have brakes.
- Can easily be customised with a wide range of accessories, to meet individual needs.

Treston Industrial Multi trolley frame

Name	Module	Size W x D x H mm	Max load kg	Code	Code ESD
Frame High	M500	540 x 760 x 1790	300	TMTFH5-41	TMTFH5-49
Frame High	M750	790 x 760 x 1790	300	TMTFH7-41	TMTFH7-49
Frame High	M900	943 x 760 x 1790	300	TMTFH9-41	TMTFH9-49
Frame Low	M500	540 x 760 x 1150	300	TMTFL5-41	TMTFL5-49
Frame Low	M750	790 x 760 x 1150	300	TMTFL7-41	TMTFL7-49
Frame Low	M900	943 x 760 x 1150	300	TMTFL9-41	TMTFL9-49



Bottom shelf

Name	Module	Size W x D x H mm	Max load kg	Code ESD
Bottom shelf M500 x 728	M500	460 x 728 x 33	100	TMTLS5-49
Bottom shelf M750 x 728	M750	710 x 728 x 33	100	TMTLS7-49
Bottom shelf M900 x 728	M900	863 x 728 x 33	100	TMTLS9-49



Steel shelf

Name	Module	Size W x D x H mm	Max load kg	Code ESD
Steel shelf M500 x 650 + brackets	M500	468 x 650 x 33	100	TMTS5-49
Steel shelf M750 x 650 + brackets	M750	718 x 650 x 33	100	TMTS7-49
Steel shelf M900 x 650 + brackets	M900	871 x 650 x 33	100	TMTS9-49



Adjustable shelf, stepless tilt

Name	Module	Size W x D x H mm	Max load kg	Code ESD
Adjustable shelf M500 x 650	M500	468 x 650 x 37	100	TMTAS5-49
Adjustable shelf M750 x 650	M750	718 x 650 x 37	100	TMTAS7-49
Adjustable shelf M900 x 650	M900	871 x 650 x 37	100	TMTAS9-49



Adjustable shelf, stepless depth and tilt

Name	Module	Size W x D x H mm	Max load kg	Code ESD
Adjustable shelf M500 x 650	M500	468 x 650 x 37	50	TMTSAS5-49
Adjustable shelf M750 x 650	M750	718 x 650 x 37	50	TMTSAS7-49
Adjustable shelf M900 x 650	M900	871 x 650 x 37	50	TMTSAS9-49



Mats for shelves

Suitability	Module	Size W x D mm	Code	Code ESD
Lower shelf TMTLS5-49	M500	455 x 723	725742-00	725750-00
Lower shelf TMTLS7-49	M750	705 x 723	725739-00	725747-00
Lower shelf TMTLS9-49	M900	858 x 723	725740-00	725748-00
Steel shelf TMTS5-49	M500	463 x 645	725738-00	725746-00
Steel shelf TMTS7-49	M750	713 x 645	725735-00	725743-00
Steel shelf TMTS9-49	M900	866 x 645	725736-00	725744-00
Adjustable shelf TMTAS5-49 and TMTSAS5-49	M500	428 x 600	860823-00	860821-00
Adjustable shelf TMTAS7-49 and TMTSAS7-49	M750	678 x 600	860548-00	860318-00
Adjustable shelf TMTAS9-49 and TMTSAS9-49	M900	831 x 600	860550-00	860320-00

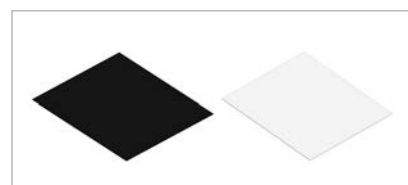

Industrial Multi trolley accessories

Name	Size W x D x H mm	Max load kg	Code	Code ESD
Wash basket L-300	380 x 302 x 110	20	839 116-51	-
Waste basket			839 159-ECO	-
Waste basket holder*			-	835 773-49
Paper roll holder*	Roll dimensions max: width 240 mm, Ø 230 mm)			860 310-49
Flow-through shelf**	718 x 835 x 61	150	-	890 710-49

For perforated panels, see page 169, for R-hooks, see page 176.

* fixing to upright

** including brackets



Adjustable trolley TRTA

For general use in workshops, offices, production areas and hospitals. Shelves are powder coated steel, RAL 7035 ESD, height 28 mm. All shelves are individually adjustable. The structure is light but sturdy. The end-frames of the trolley are made of round, powder coated steel tube (25 mm). Four swivel castors (Ø 125 mm), two of which have brakes.

Adjustable trolley TRTA

Name	Size W x D x H mm	Shelf size W x D mm	Max load kg	Code	Code ESD
2-shelf trolley*	890 x 530 x 1020	800 x 430	150	TRTA4082	TRTA4082 ESD
2-shelf trolley*	1090 x 530 x 1020	1000 x 430	150	TRTA4102	TRTA4102 ESD
2-shelf trolley*	890 x 630 x 1020	800 x 530	150	TRTA5082	TRTA5082 ESD
2-shelf trolley*	1090 x 630 x 1020	1000 x 530	150	TRTA5102	TRTA5102 ESD
4-shelf trolley**	1090 x 530 x 1515	1000 x 430	300	TRTA4104	TRTA4104 ESD
4-shelf trolley**	1090 x 630 x 1515	1000 x 530	300	TRTA5104	TRTA5104 ESD

Max load 50 kg / shelf.

* Shelf adjustments between 200-770 mm

** Shelf adjustments between 200-1340 mm

Extra shelves TRHA

Name	Shelf size W x D mm	Max load kg	Code	Code ESD
Extra shelf	800 x 430	50	TRHA408	TRHA408 ESD
Extra shelf	1000 x 430	50	TRHA410	TRHA410 ESD
Extra shelf	800 x 530	50	TRHA508	TRHA508 ESD
Extra shelf	1000 x 530	50	TRHA510	TRHA510 ESD

End mesh panels NET2

Name	Size W x D mm	Set	Code ESD
End mesh panel	604 x 364	Incl. 2 panels	NET2

The mesh panels can be installed at the ends of the trolley or on the sides. An angle bracket is set on the edge of the upper and lower shelf and the mesh is screwed into place. The 4-shelf trolley can hold 2 mesh panels on top of each other.

Document holder DSA4

Name	Size	Code ESD
Document holder	A4	DSA4 ESD

Semiconductive epoxy powder coated steel. Includes two blue magnets.

Low M-divider hoops LDH

Name	Size	Code
Divider hoops	460 x 315	LDH

Steplessly adjustable. 4 pcs per set. M-shape (the lowest point 105 mm from shelf). Suitable only 430 mm deep shelves.



Low M-divider hoops LDH



Document holder

Reel holder trolley RRT

The adjustable reel holder trolley is compatible with SMD reels, and suitable for transport and stocking of them. All parts are powder coated steel, RAL 7035 ESD. The trolley has four perforated steel shelves, 1090 x 460 x 28 mm. All shelves are individually adjustable between 200-1605 mm.

The zinc plated reel racks that fit into the shelves are to be ordered separately. The structure is light but sturdy. The end-frames of the trolley are made of round, powder coated steel tube (25 mm). Four turning castors with brakes (Ø 125 mm). The load capacity of one shelf is 50 kg, and the load capacity of the trolley is 200 kg.

Reel holder trolley RRT

Name	Size W x D x H mm	Max load kg	Code ESD
1. Reel holder trolley	1100 x 530 x 1780	200	RRT ESD
2. Reel rack	960 x 426 x 254	50	RR ESD-Z
3. Document holder	A4		DSA4 ESD

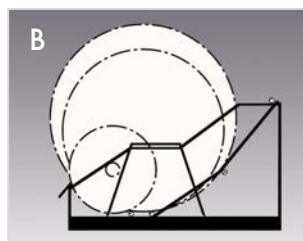
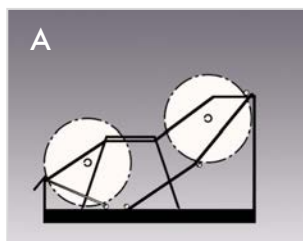
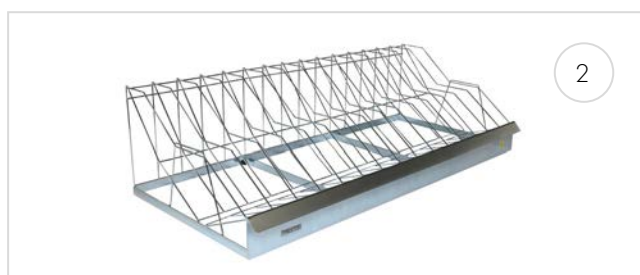

In picture A: Side view of spools and reel racks. The capacity of one rack is 30 fixed compartments for 7" spools of 60 mm width.

In picture B: Side view of spools and reel racks. The capacity of one rack is 15 fixed compartments for 13" and 15" spools of 60 mm width.



Mobile workstations

MLC mobile workstation is a light, ergonomic and easy-to-move workstation. The mobile workstation moves and turns effortlessly even in tight spaces. A laptop computer can be placed on the worktop or underneath it, in which case only the screen is visible. A wide range of accessories is available, with all the necessary supplies included.

- An ergonomic workstation that is light to move around - aluminium frame, steel legs
- Standard features include a laminated worktop and a lockable computer compartment with holes for wires
- Four swivel castors (Ø125 mm), two with brakes



MLC mobile workstation

MLCT mobile height adjustable work surface is a compact sized additional work surface with easy gas spring height adjustment. It is ideal for tight spaces and tasks where easy manoeuvrability is a must. Optimal for handling light loads and small sized objects. Ideal also for laptop use. Suitable for technical and EPA environments where easy ergonomics and mobility are required.

- Easy to move around due to the light construction - aluminium frame, symmetric steel legs
- Accessories available: Accessory box underneath the table top, accessories basket to the frame and a folder holder
- Four swivel castors (Ø100 mm), two with brakes



MLCT mobile height adjustable work surface

Mobile workstations

Name	Size W x D mm	Height mm*	Top size mm	Max load kg	Code	Code ESD
Mobile workstation	590 x 540	800-1200	520 x 370 x 25	12	MLC 405PG	MLC 405PG ESD
Mobile height adjustable work surface	600 x 500	760-1185	580 x 490 x 25	25**	MLCT 605PG	MLCT 605PG ESD

*Height is adjusted by gas spring.

** 150 N gas spring lightens the load with app. 10 kg upon lifting.

Mobile workstation accessories

Name	Description	Suitability	Code
1. Keyboard and mouse tray	210 x 620 mm. Equipped with a wrist support.	MLC	KH620N
2. Binder mount	Fits a single 75 mm wide binder.	MLC, MLCT	FH1
3. Accessories basket	Blue bin, int. dim. 230 x 155 x 140 mm	MLC, MLCT	AB1930
4. LCD bracket	Load capacity 15 kg, mounting holes 75 x 75 / 100 x 100 apart	MLC	MH
5. LCD support arm	For the attachment of MH and MY supports. Max 22" screen.	MLC	MS
6. Tablet bracket	For 7-10" tablets. Requires either an MH, MA or MA2 swivel arm.	MLC	MY
7. Accessory box	With grey shelf bin 4020-3.	MLCT	AB4020-3
7. Accessory box ESD	With ESD shelf bin 4020-4ESD.	MLCT	AB4020-4ESD



1



2



3



4



5



6

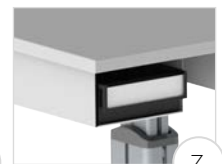

7

Trolleys for additional workspace

Storage trolley is an easy solution for mobile storage, the storage trolley has an adjustable middle shelf, and the shelves are fitted with ESD or standard rubber mats.

SAP trolley provides extra workspace for the TP workbench. Lower self, extra shelf and handle are available separately. Height adjustment with allen key between 650-900 mm.

Concept trolley provides extra workspace for Concept and WB workbenches. Lower shelf is integrated. Can be equipped with an additional shelf or drawer unit 30 series. Height adjustment with allen key between 650-900 mm.



Trolleys for additional workspace

Name	Size W x D x H mm	Max load kg	Code	Code ESD
Storage trolley	650 x 450 x 775	3 x 30	852 773-41	852 773-49
SAP trolley	700 x 500	150	SAP507	SAP507 ESD
SAP trolley	1000 x 700	150	SAP710	SAP710 ESD
Lower shelf for SAP trolley	700 x 500	40	AT507	AT507 ESD
Lower shelf for SAP trolley	1000 x 700	40	AT710	AT710 ESD
Extra shelf for SAP trolley	700 x 500	40	LT507	LT507 ESD
Extra shelf for SAP trolley	1000 x 700	40	LT710	LT710 ESD
Handle for SAP trolley	depth 500		PUSH50	PUSH50
Handle for SAP trolley	depth 700		PUSH70	PUSH70
Concept trolley	500 x 700 x 650-900	150	CONT705-41	CONT705-49
Extra shelf for Concept trolley	400 x 500	25	CONTS504-49	CONTS504-49
Drawer unit 30/15	300 x 454 x 150	10	859 330-49	859 330-49
Drawer unit 30/22	300 x 454 x 220	10 / drawer	859 340-49	859 340-49
Drawer unit fastening set			890 653-49	890 653-49

All the light-duty trolleys are equipped with four swivel castors (ø 100 mm), two of which have brakes.



Storage trolley



SAP trolley with AT lower shelf, LT extra shelf and PUSH handle



Concept trolley, extra shelf and drawer unit 30/15

Packing trolleys

Low carton trolley LCT610

Trolley for large cartons. Three dividers can be assembled crosswise or lengthwise. The fourth divider is a push handle.

Frame and shelf are of epoxy powder-coated steel in grey RAL 7035. Four swivel castors (Ø 100 mm), two of which have brakes. Shelf height above the ground 160 mm.

Size W x D x H mm	Shelf size W x D mm	Max load kg	Code
1080 x 630 x 1020	1000 x 630	150	LCT610



High carton trolley HCT410

Trolley for packing cartons. Shelves are equipped with steplessly adjustable steel M-divider hoops. Larger hoop height 540 mm, lowest point 330 mm above the shelf, smaller hoop height 315 mm, lowest point 105 mm above the shelf.

Frame and individually height adjustable shelves are of epoxy powder-coated steel in grey RAL 7035. Four swivel castors (Ø 100 mm), two of which have brakes.

Size W x D x H mm	Shelf size W x D mm	Max load kg	Code
1090 x 530 x 1515	1000 x 430	150	HCT410



Carton trolley

Name	Description	Size W x D x H mm	Code
1. Castor Set	Castor set for carton trolley. The castor set gives you a trolley from the SPM-shelf.	600 x 125	SPMCS-41
2. Shelf for packing material	600 mm deep shelf for many purposes. The shelf can also be equipped with PDH600 divider hoops. Max load 60 kg.	467 x 600 x 32	SPM500-49
		717 x 600 x 32	SPM750-49
		870 x 600 x 32	SPM900-49
		1167 x 600 x 32	SPM1200-49
		1317 x 600 x 32	SPM1350-49
		1467 x 600 x 32	SPM1500-49
3. Divider hoops set (4 pcs), SPM-shelf	Divider hoop set for the SPM-shelves. Height 280 mm. The fixed divider is tightened with the screw at the front edge of the shelf.	1773 x 600 x 32	SPM1800-49
		8 x 400 x 280	PDH600-49

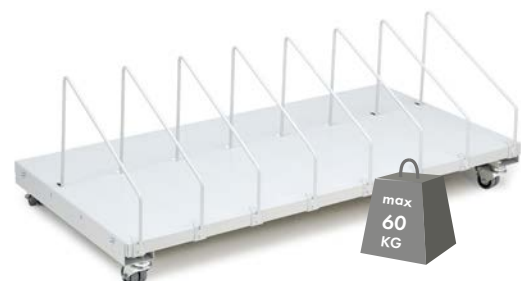
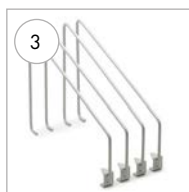

Industrial multi trolley frame with accessories

Name	Description	Module	Size W x D x H mm	Code
1. Industrial multi trolley frame	Max load 300 kg.	M750	790 x 760 x 1790	TMTFH7-41
		M900	943 x 760 x 1790	TMTFH9-41
2. Shelf for packing material	600 mm deep shelf for many purposes. The shelf can also be equipped with PDH600 divider hoops. Max load 60 kg.		717 x 600 x 32	SPM750-49
			870 x 600 x 32	SPM900-49
3. Brackets for upright tube SPM	Mounting parts for top shelf to the upright tube. With the mounting kit, you attach the SPM shelf to the upright tube.			SPMBS-49
4. Divider hoops set SPM-shelf	Divider hoop set (4 pcs) for the SPM-shelves. Height 280 mm. The fixed divider is tightened with the screw at the front edge of the shelf.		8 x 400 x 280	PDH600-49
5. Aluminium bin rail	For auxiliary steel shelf, stacking and picking bins. Very sturdy. Max load 15 kg.	M750	736 x 55 x 75	BP750C
		M900	889 x 55 x 75	BP900C
6. Tablet bracket MY	Tablet bracket for 7-10" tablets.			MY
LCD bracket MH	The quick-release mechanism is equipped with the standard used flat-screen mount 75 x 75 and 100 x 100 for the mounting of all normal flat screens.			MH
Adapter set	Adapter set for fixing LCD bracket MH to the upright tubes.		200 x 110 x 60	AS2
7. Auxiliary steel shelf	Shelf for A4 paper and tape dispensers (max 2 pcs per shelf). Mounted on bin profile. Max load 3 kg.		217 x 298 x 20	ASSA4
8. Roll holder set	Roll holder set for packing material rolls. Max load 40 kg.	M750		890 547-49P
		M900		890 548-49P
9. Fixed tape dispenser	Feeds tape from a roll; for a tape roll with a 76-mm socket. Includes screws to fix the dispenser to ASSA4. Max roll Ø 120 mm and width 50 mm.			FTD50
10. Basic label dispenser	Feeds labels from a roll, space for several rolls. Fits on ASSA4 or can be placed in a shelf or tray. Can be fixed with screws. Max roll Ø 220 mm and width 210 mm.			BLD20
11. Document holder A4	Steel document holder fixed on upright tube. Easily adjustable with the double arm. Max load 5 kg.			928 49 008P
12. Equipment tray	With double arm and handle. For small tools and packing accessories such as BLD20. Max load 15 kg.		500 x 250 x 125	928 49 002P

Please visit our webpage for full range of module M750 and M900 accessories.

Recycling material trolley PRMT

The recycling trolleys are ideal for placing underneath or beside the packing bench. The bins are adjustable in angle for ease of use! The trolley comes with four swivel castors, two with brakes. Available in single and double version.

Size W x D x H mm	Code
350 x 625 x 765	PRMT 1
680 x 625 x 765	PRMT 2



Industrial multi trolley frame with accessories

Heavy-duty trolley

Heavy-duty trolleys, as their name indicates, are ideal for moving heavy loads. Their special castors support extremely heavy weights. The total capacity of the basic model is up to 600 kg!

The heavy-duty trolleys are equipped with two fixed castors (Ø 100 mm) and two swivel castors with brakes.



Heavy-duty trolley 1, code C 750 41 001



Heavy-duty trolley 2, code C 750 41 002

Heavy-duty trolleys

Name	Size W x D x H mm	Max load kg	Code
Heavy-duty trolley 1	935 x 785 x 830	600	C 750 41 001
Heavy-duty trolley 2	935 x 785 x 830	600	C 750 41 002

Heavy-duty trolley accessories

Name	Size W x D x H mm	Max load kg	Code
Shelf	812 x 770 x 30	400	852 671-49

Heavy-duty trolley 3, code C 750 07 103

Qty	Name	Size mm	Code
1	Bottom shelf	933 x 780	852 666-49
1	Perforated uprights, pair	661	852 668-49
1	Perforated uprights, pair	1359	852 667-49
1	Cross support, pair		852 669-49
1	Handle		852 670-49
1	Pvc-top, steel edges	1000 x 750	836 723-79
1	Corner hooks		848 336-49
1	Horizontal tube M900	873	840 104-49
2	Fixed castors	Ø100	1988
2	Swivel castors	Ø100	1987
1	Perforated panel	870 x 389	861 516-49
1	Suspension rail M900	895	859 152-49
6	Plastic box 1525-5		1525-5
1	Fixing set		870 811-00
1	Drawer unit 55/37	550 x 715 x 370	611 07 001



Heavy-duty trolley 3, code C 750 07 103

Size 1000 x 810 x 1590 mm
 Top 1000 x 750 mm
 Worktop height 850 mm

Fitter's trolley

A fitter's trolley lets you take your supplies and tools wherever you go, while keeping them organised. Rubber mats and ESD-mats for shelves available separately.

The fitter's trolleys are equipped with four swivel castors (Ø 125 mm), two of which have brakes. Fitter's trolley can be combined with all M750 accessories.

Fitter's trolleys

Name	Module	Size W x D x H mm	Max load kg	Code	Code ESD
Fitter's trolley 1	M750	790 x 760 x 875	300	C730 41 001	C730 49 001
Fitter's trolley 2	M750	790 x 760 x 875	300	C730 41 002	C730 49 002
Fitter's trolley 3	M750	790 x 760 x 875	300	C730 41 003	-
Fitter's trolley, frame	M750	790 x 760 x 875	300	C730 41 000	C730 49 000

Fitter's trolley accessories

Name	Module	Size W x D x H mm	Max load kg	Code	Code ESD
Lower shelf M750 x 728	M750	710 x 728 x 33	100	TMTLS7-49	
Steel shelf M750 x 650 + brackets	M750	718 x 650 x 33	100	TMTS7-49	
Adjustable shelf M750 x 650	M750	718 x 650 x 37	100	TMTAS7-49	
Adjustable shelf M750 x 650, stepless depth adjustment	M750	718 x 650 x 37	50	TMTSAS7-49	

Fitter's trolleys can be combined with M750 accessories.

Mats for shelves

Suitability	Module	Size W x D mm	Code	Code ESD
Lower shelf TMTLS7-49	M750	705 x 723	725739-00	725747-00
Steel shelf TMTS7-49	M750	713 x 645	725735-00	725743-00
Adjustable shelf TMTAS7-49 and TMTSAS7-49	M750	678 x 600	860548-00	860318-00

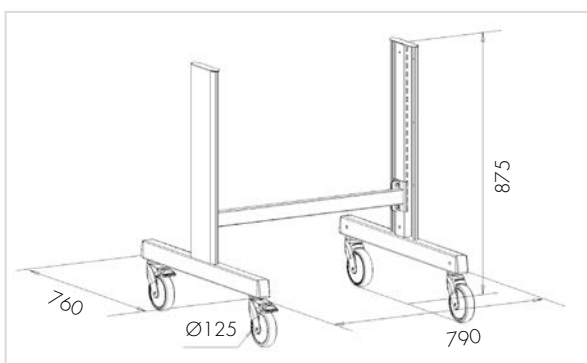

Fitter's trolley frame



Fitter's trolley 1



Fitter's trolley 2



Fitter's trolley 3

Fitter's trolley 3 includes 6 cone racks. Tool holders, page 168, ordered separately.

Cone rack M750 for tool holders HSK, Capto, ISO

Name	Size W x D x H mm	Max load kg	Code
Cone rack M750	742 x 206 x 95	50	890 729-49

See tool holders on page 168.



Cone rack M750

Tool trolley

Sturdy tool trolley for workshop and garage environment. Tool trolley is very practical working surface with drawers and cabinets to store tools and components. Push handle and lightly rolling castors makes moving the trolley easy where ever needed. Several combinations available.

The tool trolleys have drawers with actual full opening telescopic ball-race rails. Maximum load 60 kg per drawer and 50 kg per shelf. Two fixed castors and two swivel castors with brakes (Ø100). Steel or vinyl top 910 x 525 x 30 mm.



Tool trolley 1

Tool Trolley 1

Size W x D x H mm	Max load kg	Code steel top	Code vinyl top
910 x 525 x 880	300	Twin45-001-41	Twin45-101-41

5 fully opening drawers and 1 cabinet. All lockable. Cabinet has 1 height adjustable shelf.

Tool Trolley 2

Size W x D x H mm	Max load kg	Code steel top	Code vinyl top
910 x 525 x 880	300	Twin45-002-41	Twin45-102-41

2 fully opening drawers and 2 cabinets. All lockable. Both cabinets have 1 height adjustable shelf.



Tool trolley 2

Tool Trolley 3

Size W x D x H mm	Max load kg	Code steel top	Code vinyl top
910 x 525 x 880	300	Twin45-003-41	Twin45-103-41

8 lockable fully opening drawers.



Tool trolley 3

Tool Trolley 4

Size W x D x H mm	Max load kg	Code steel top	Code vinyl top
910 x 525 x 880	300	Twin45-004-41	Twin45-104-41

9 lockable fully opening drawers.



Tool trolley 4

Tool Trolley 5

Size W x D x H mm	Max load kg	Code steel top	Code vinyl top
910 x 525 x 880	300	Twin45-005-41	Twin45-105-41

4 lockable fully opening drawers and 2 open height adjustable shelves. Shelves with raised edges.



Tool trolley 5

Perforated panel kit

Size W x D x H mm	Code
780 x 30 x 685	890 768-49

Practical perforated panel kit for tool hooks can be mounted on tool trolley.

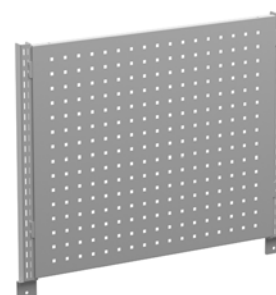

Perforated panel kit

Drawer interiors for tool trolley

Divider set 1

Model	Code
Drawer 45/100	872 991-49
Drawer 45/ 150 and 45/200	872996-49

4 x horizontal dividers 375

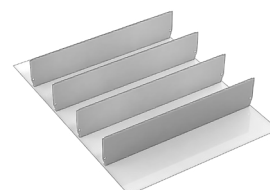

Divider set 2

Model	Code
Drawer 45/100	872 992-49
Drawer 45/ 150 and 45/200	872 997-49

1 x vertical divider, 8 x divider plate 185

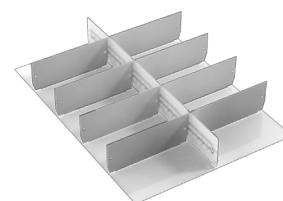

Divider set 3

Model	Code
Drawer 45/100	872 993-49
Drawer 45/ 150 and 45/200	872998-49

1 x vertical divider, 4 x divider plate 125, 4 x divider plate 250

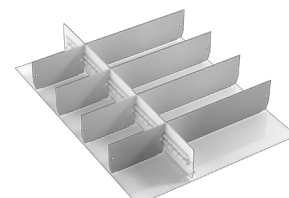

Divider set 4

Model	Code
Drawer 45/100	872 994-49
Drawer 45/ 150 and 45/200	8729 99-49

2 x vertical divider, 12 x divider plate 125

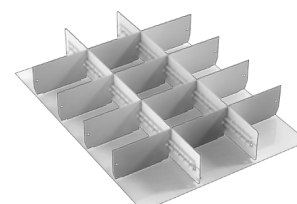

Service trolley

The service trolley frame is equipped with a safety locking feature that allows only one drawer to be opened at a time. The cover comes as standard with a separate rubber mat that prevents items from slipping.

Both sides of the trolley have standard, perforated panels that you can accessorise with brackets and mountings, to suit any application. Service trolleys are also equipped with two fixed castors (Ø 150 mm) and two swivel castors including brakes (Ø 100 mm).



Service trolley
Size 710 x 480 x 875 mm
Max load 300 kg

+ Customise your service trolley with a selection of hooks from page 184.

Service trolleys

Model	Service trolley 1	Service trolley 2	Service trolley 3	Service trolley 4	Service trolley 5	Service trolley 6	Service trolley 7	Service trolley 8
Code	710 07 001	710 07 002	710 07 003	710 07 004	710 07 005	710 07 006	710 07 007	710 07 008
Height (mm) of the drawer	3 x 75 	2 x 75 	1 x 75 	5 x 75 	2 x 75 	1 x 100 	1 x 100 	1 x 100
	1 x 125 	2 x 100 	4 x 100 	1 x 100 	2 x 100 	2 x 250 	2 x 125 	4 x 125
	1 x 250 	2 x 125 	1 x 125 	1 x 125 	1 x 250 		1 x 250 	

Internal drawer dimensions: 600 x 345 x 63/88/113/238 mm. Drawers open 90% and loading capacity is 50 kg/drawer.

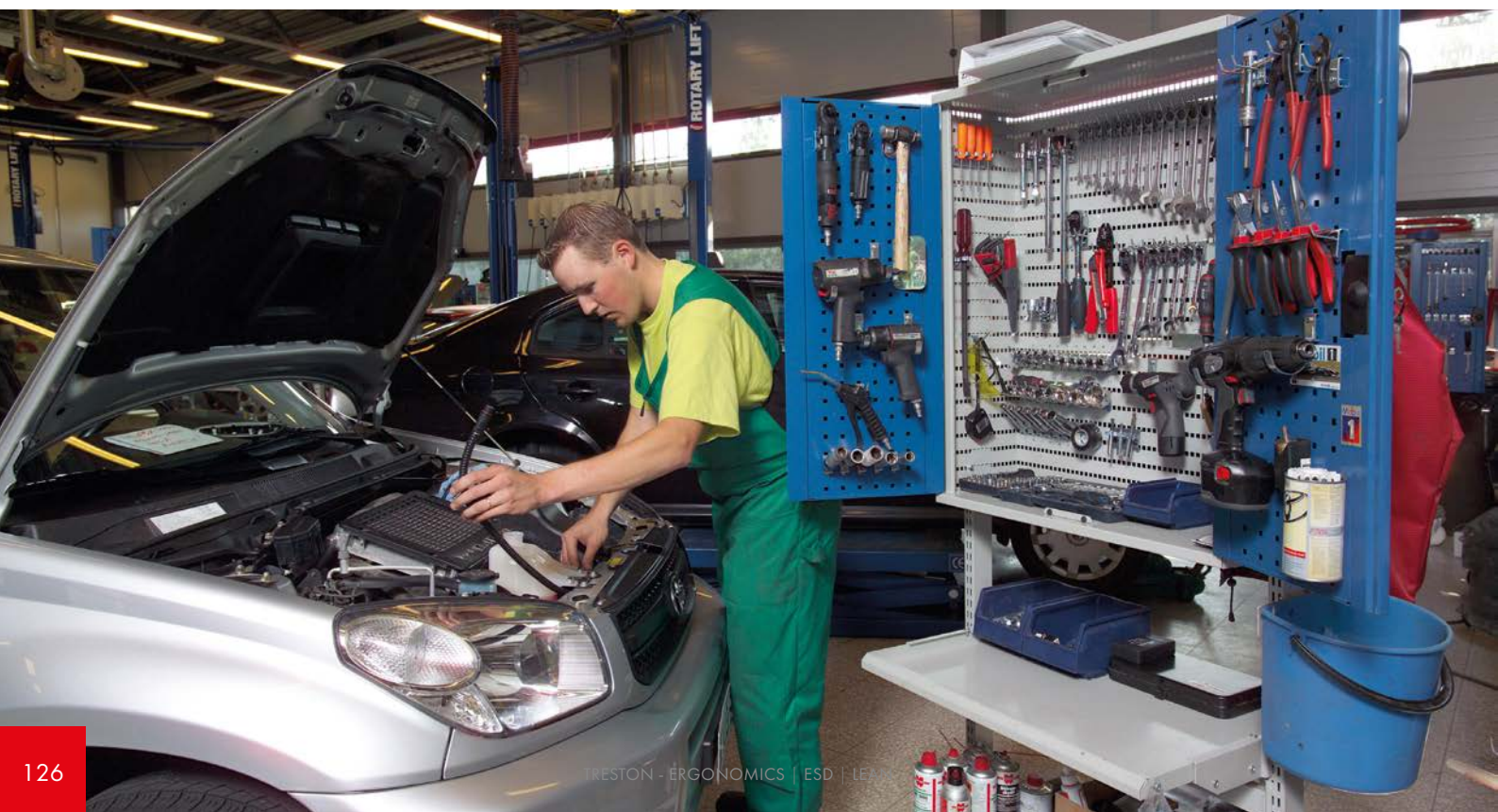

Accessorised service trolley

By attaching the upright tube pair 30 x 30 mm (code 854 038-49), you can use all the M500 accessories.

Accessories for service trolley (in the picture)

Qty	Name	Size mm	Code
1	Perforated upright pair	30 x 30 x 1219	854 038-49
1	Perforated tool cabinet	470 x 200 x 600	854 039-07
1	Suspension rail	M500	860 953-49
5	Plastic container		30-1L-6
1	Vice support		854 037-45
1	Pick-up box holder	165 x 48 x 456	854 042-49
4	Pick-up box	149 x 85 x 48	851 843-00
1	Utility box	155 x 90 x 410	854 041-49
1	Paper roll dispenser*		854 043-49
1	Waste bucket holder*		854 044-49
1	Waste bucket		839 159-ECO
1	Folder compartment	466 x 90 x 240	854 040-49

* Fixing to perforated panel



Drawer interiors for service trolley



Tool troughs 45 and 70 mm

Drawer 71/75 854 066-00
6 x 45 mm, 4 x 70 mm



Middle dividers and plates 2

3 x middle divider, 6 x middle plate
150 and 2 x middle plate 300*

Drawer 71/75 854 069-49

Drawer 71/100 854 070-49

Drawer 71/125 854 070-49

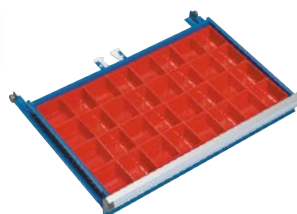

Pick up boxes

Drawer 71/75 854 064-00

Includes 16 pick-up boxes with
dividers.



Rubber mat for the drawer bottom

Rubber mat 71 854 078-00

* One example of interior solutions shown in picture.

Stacking bin trolley

A storage system for stores, production facilities and warehouses. It is easily moved to wherever it is needed. You can configure the trolley to match your needs.

- Double-sided trolley for stacking bins
- Powder-coated (light grey, RAL 7035), steel-frame trolley with a fixed bottom shelf
- Up to 112 stacking bins can be attached to one trolley, must be ordered separately
- Four different sizes of stacking bins to choose from
- Height adjustable ergonomic push handle
- Sixteen step-by-step height adjustable bin rails, eight bin rails per side, length of bin rails 742 mm
- Height of the bin rails can be adjusted easily without tools
- Four swivel castors (Ø 100 mm), two with brakes
- Module M750, all the upright tube accessories are available



1 x trolley BT-170B
40 x blue stacking bin 1520-6
32 x blue stacking bin 1930-6

Trolley BT-170B

Size W x D x H mm	Max load kg	Code	Code ESD
790 x 760 x 1770	300*	BT-170B	BT-170B ESD

*Load capacity for bin rail 50 kg

Suitable stacking bins

Code	Quantity/rail	Max. quantity/trolley
1015	7 pcs	112 pcs
1520	5 pcs	80 pcs
1525	5 pcs	80 pcs
1930	4 pcs	64 pcs

Details of stacking bins can be found on page 202.



Add accessories as needed!

Accessories starting from page 57. All module M750 accessories suit stacking bin trolley.



Bottle holder Ø 100



Equipment tray



Tool panel

Cabinet trolley for small-parts storage cabinets

This assembly holds 8 cabinets, which must be ordered separately. This double sided trolley has 4 swivel castors (Ø 100 mm), two of which have brakes. One steel bottom shelf comes as standard. Height-adjustable ergonomic push handle makes the trolley easy to move.

Powder-coated (light grey, RAL 7035) steel frame with a fixed bottom shelf. Height of the fixing rails can be adjusted easily without tools. Module M750, all the upright tube accessories are available for cabinet trolley.

Trolley BT-550B

Size W x D x H mm	Max load kg	Code	Code ESD
790 x 760 x 1770	300	BT-550B	BT-550B ESD

Maximum eight small-parts cabinets, 4 on each side, to be ordered separately.

Suitable small-parts storage cabinets

Code	Includes small drawers	Small drawer dimensions W x D x H
550-3	L-00 (60 pcs)	55 x 175 x 37
551-3	L-01 (48 pcs)	69 x 175 x 37
551-4ESD	L-61-4ESD (48 pcs)	69 x 170 x 40
552-3	L-02 (24 pcs)	138 x 175 x 37
554-3	L-04 (24 pcs)	92 x 175 x 59
554-4ESD	L-64-4ESD (24 pcs)	92 x 170 x 62
556-3	L-06 (8 pcs)	277 x 175 x 59
557-3	L-07 (12 pcs)	138 x 175 x 81
550C-3	L-01 (24 pcs)	69 x 175 x 37
	L-04 (6 pcs)	92 x 175 x 59
	L-06 (2 pcs)	277 x 175 x 59

Details of series 550 can be found on page 192.



1 x trolley BT-550B
8 x small-parts storage cabinets 551-4ESD



Add accessories as needed!

Here are some examples of accessories suitable for trolley BT-550B. See page 57 for full range of module M750 accessories.



Tablet bracket



Document holder A4



6. Drawer units

Versatile drawer units



We provide a comprehensive range of different drawer units for a variety of purposes. You can fix any drawer unit from the same series under a worktop or on a plinth, or equip them with castors to take along to your next workstation.

Efficient storage and control

Our drawer units are great for storing tools and supplies. It is surprising how much time is spent finding tools and other items if they are not stored systematically. The versatile interior combinations of our drawer units guarantee that your supplies are always at hand and in good order.

A comprehensive range of drawer units

We promise that you will find a drawer unit that meets your requirements in our comprehensive range. You can choose from several different heights and drawer and interior combinations. We have selected some combinations for this brochure. For more options, please contact: sales@treston.com.



Combination name

45/56-1

Width Height Version

Light steel cabinet LMC

These steel cabinets are an ideal way of providing individual secure storage for your staff. Drawers are mounted on telescopic ball race slides. Four cabinet sizes, including one drawer/cupboard combination. The cabinet frames are epoxy powder coated steel; drawer fronts are composite board with aluminium handles. Colour light grey, RAL 7035. Mount on benches with brackets (included).

Suitable for
WB/TP/TPB/TPH
workbenches and
SAP/WTR trolleys



Light steel cabinet, load capacity 15 kg/drawer, 70 % opening

Code	LMC01	LMC02	LMC04	LMC04D
Code ESD	LMC01 ESD	LMC02 ESD	LMC04 ESD	LMC04D ESD
Outer dims W x D x H mm	370 x 460 x 135	370 x 460 x 245	370 x 460 x 455	370 x 460 x 455
Includes drawers (outer height mm)	1 x 100	2 x 100	4 x 100	1 x 100 + cupboard, height 300 mm, open to right

Internal drawer dimensions: 278 x 438 x 75 mm

Cover LMCK2

Description	Code
Needed for mounting cabinets to WB benches and WTR trolley.	LMCK2



Drawer units 30 and 35

These drawer units are fastened under a workbench to provide storage space. Choose from single drawer, two drawers or drawer cabinet. If additional drawers are needed, they can be easily attached to each other. The drawers can be locked to protect the contents.

Drawer cabinet 35/47 is suitable for storing upright folders.



Drawer units 30 and 35, load capacity 10 kg/drawer, 80 % opening

	30/15	30/22	35/47
Code	859 330-49	859 340-49	860 972-49
Outer dims W x D x H mm	300 x 454 x 150	300 x 454 x 220	350 x 470 x 470
Includes drawers (outer height mm)	1 x 150	2 x 110	1 x 110 + cupboard, height
Internal drawer dimensions:	255 x 400 x 120 mm	255 x 400 x 75 mm	300 x 400 x 70 mm

Fastening sets for drawer unit 30 and 35 (should be selected according to the type of the workbench)

Depth	600 mm	700 mm	750 mm	800 mm	900 mm
Concept, allen key adjustable	890 653-49	-	890 653-49	-	890 653-49
Concept, hand crank adjustable	-	-	890 653-49	-	890 653-49
Concept, motor adjustable	-	-	854 463-49	-	854 463-49
TED	-	-	-	855 057-49	-
TP / TPH / TPB	-	855 054-49	-	-	855 054-49
WB	-	-	-	855 054-49	-

Not adapted to Concept handcrank and motor adjustable bench (depth 600 mm).

Drawer unit 30/22 is also available with a secure and up-to-date electronic code lock.

This electronic locking system replaces keys with a numerical code. The code is easy to change when needed, for example, for a different user and thus this drawer unit is an excellent choice when high convenience and confidentiality are needed.

The locking system is operated with 2 x AAA batteries and is thus independent from an external power supply. Due to an automatic low power (sleep) mode, the batteries last long, and even when the battery power is low, the lock can still be opened 300 more times.

Drawer unit 30/22 with electronic code lock, order code 720010-49.



Drawer unit 45

Centrally locked high quality steel drawer units for storage of tools and small components. Mounted under workbenches with brackets. Also available with castors as a trolley version. Drawer units are epoxy powder coated in grey, RAL 7035. Central locking. Full width drawer handle in anodised aluminium. Smooth and quiet telescopic ball-race runners with 100 % opening of the drawers. Load-bearing capacity is 60 kg per drawer. Our drawer units are suitable for use in EPAs. The mobile trolleys are available in both ESD and non- ESD versions.

Drawers open 100% and their load capacity is 60 kg.

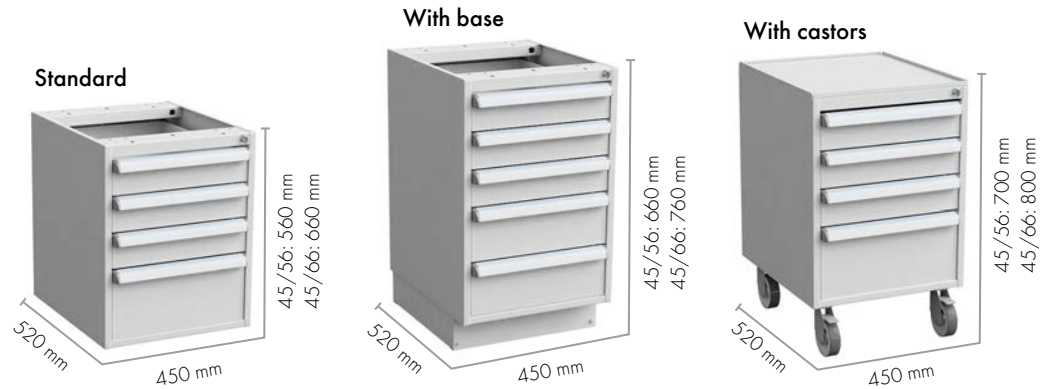

Load capacity 150 kg, 4 swivel castors (ø 100 mm), 2 with brakes. The trolley version comes with a rubber mat that stops items from sliding on the surface.

- Choose the drawer unit according to your needs; with castors, base or no base.
- Drawer units with castors are also available as non ESD-versions (code 41 instead of 49).

Internal drawer dimensions mm	
Width 380	Depth 500
Outer height mm	Inner height mm
100	90
150	140
200	190
300	290

1. Drawer unit 45/14-1

Drawers	Code
100 x 1	Standard 603 49 001

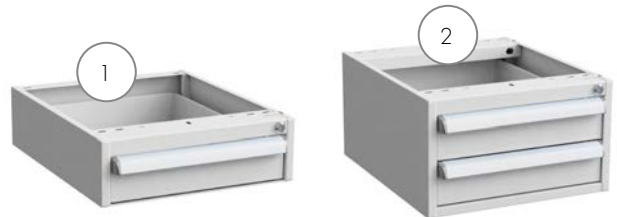

2. Drawer unit 45/26-1

Drawers	Code
100 x 2	Standard 604 49 001

3. Drawer unit 45/56-2

Drawers	Code	Code	Code
	Standard	With base	With castors
100 x 2, 150 x 2	606 49 102	606 49 202	606 49 302



4. Drawer unit 45/56-3

Drawers	Code	Code	Code
	Standard	With base	With castors
100 x 3, 200 x 1	606 49 103	606 49 203	606 49 303

5. Drawer unit 45/66-1

Drawers	Code Standard	Code With base	Code With castors
100 x 6	607 49 101	607 49 201	607 49 301



6. Drawer unit 45/66-2

Drawers	Code Standard	Code With base	Code With castors
100 x 3, 150 x 2	607 49 102	607 49 202	607 49 302

7. Drawer unit 45/66-6

Drawers	Code Standard	Code With base	Code With castors
100 x 2, 200 x 2	607 49 106	607 49 206	607 49 306



8. Drawer unit 45/66-7

Drawers	Code Standard	Code With base	Code With castors
200 x 3	607 49 107	607 49 207	607 49 307

Additional drawer units 45/56

	45/56-1	45/56-4	45/56-7	45/56-10	45/56-11
Standard	606 49 101	606 49 104	606 49 107	606 49 110	606 49 111
With base	606 49 201	606 49 204	606 49 207	606 49 210	606 49 211
With castors	606 49 301	606 49 304	606 49 307	-	-
100	x 5	x 1	-	x 2	-
150	-	-	x 2	-	-
200	-	x 2	x 1	-	x 1
300	-	-	-	x 3	x 1

Additional drawer units 45/66

	45/66-3	45/66-4	45/66-5	45/66-12	45/66-13	45/66-14	45/66-15
Standard	607 49 103	607 49 104	607 49 105	607 49 112	607 49 113	607 49 114	607 49 115
With base	607 49 203	607 49 204	607 49 205	607 49 212	607 49 213	607 49 214	607 49 215
With castors	607 49 303	607 49 304	607 49 305	-	-	-	-
100	x 1	-	x 4	x 3	-	x 1	-
150	x 2	x 4	-	-	x 2	-	-
200	x 1	-	x 1	-	-	x 1	-
300	-	-	-	x 1	x 1	x 1	x 2

Cabinet 45/56, door right

	w/o lock	with lock
Standard	606 49 105	606 49 108
With plinth	606 49 205	606 49 208
With castors	606 49 305	606 49 308

Cabinet 45/56, door left

	w/o lock	with lock
Standard	606 49 106	606 49 109
With plinth	606 49 206	606 49 209
With castors	606 49 306	606 49 309



Cabinets include one bottom shelf and one adjustable shelf, shelf load capacity 50 kg.

Drawer cabinet 45/66, door right

drawer 1 x 100	w/o lock	with lock
Standard	607 49 108	607 49 110
With plinth	607 49 208	607 49 210
With castors	607 49 308	607 49 310

Drawer cabinet 45/66, door left

drawer 1 x 100	w/o lock	with lock
Standard	607 49 109	607 49 111
With plinth	607 49 209	607 49 211
With castors	607 49 309	607 49 311



Cabinets include one bottom shelf and one adjustable shelf, shelf load capacity 50 kg.

Fastening sets for drawer unit 45 (should be selected according to the type of the workbench)

Depth	600 mm	700 mm	750 mm	800 mm	900 mm
Concept, allen key adjustable	890 653-49	-	890 653-49	-	890 653-49
Concept, hand crank adjustable	-	-	890 653-49	-	890 653-49
Concept, motor adjustable	-	-	854 463-49	-	854 463-49
TP / TPH / TPB	-	855 055-49*	-	-	855 055-49*
WB	-	-	-	855 055-49*	-

Not adapted to Concept handcrank and motor adjustable bench (depth 600 mm).

* Standard drawer unit models include fastening set. For drawer unit models with plinth the fastening set 855 055-49 is available only upon order.

For heavy loads we recommend adding a plinth or castors to the drawer unit.

Cover

Description	Code
Needed for mounting drawer unit 45 to WB benches.	855 060-49



Pencil box

Description	Code
Add a pencil box in the drawer to organise small items more efficiently. Cannot be used together with the drawer divider sets.	854 850-49



Hanging file support for 45/300 drawer

Size (inner) W x D x H mm	Code
327 x 492 x 150	W872245-49



Drawer interiors

Divider set 1

Model	Code
Drawer 45/100	872 991-49
Drawer 45/ 150 and 45/200	872 996-49
4 x horizontal dividers 375	

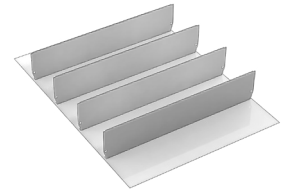

Divider set 2

Model	Code
Drawer 45/100	872 992-49
Drawer 45/ 150 and 45/200	872 997-49
1 x vertical divider, 8 x divider plate 185	

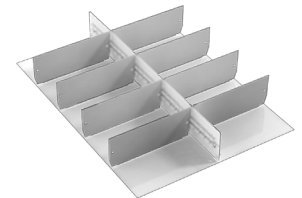

Divider set 3

Model	Code
Drawer 45/100	872 993-49
Drawer 45/ 150 and 45/200	872 998-49
1 x vertical divider, 4 x divider plate 125, 4 x divider plate 250	

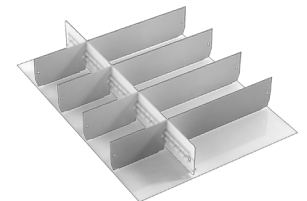

Divider set 4

Model	Code
Drawer 45/100	872 994-49
Drawer 45/ 150 and 45/200	872 999-49
2 x vertical divider, 12 x divider plate 125	

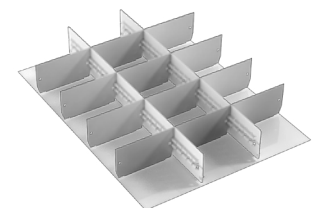

For additional divider parts see page 211.

Drawer units with castors are also available as non ESD-versions (code 41 instead of 49).



Drawer unit 55

With these heavy-duty drawer units you can optimise your storage and keep all your items perfectly organised. The safety locking prevents other drawers from opening while one drawer is open (always lock the drawers during transport). You can choose the best option from three heights to meet your needs, or add height or width with different drawer unit combinations.

The units with plinth can also be used workbench legs and the smaller drawers are easily fastened under a workbench. The 66-cm-high drawer unit includes optional castors, making it an excellent choice for a mobile workstation. The unit with castors comes with a rubber mat that stops items from sliding on the surface. The version with doors is ideal for storing larger items.

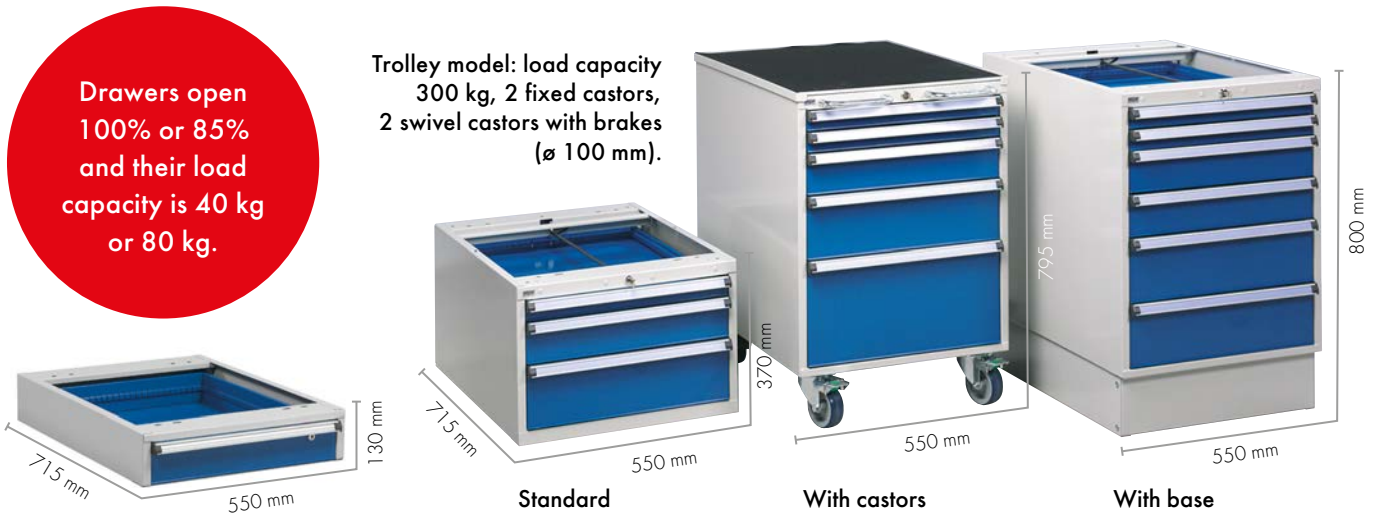

- Choose the drawer unit according to your needs; with castors, base or no base.
- The 50 mm high drawer is fully opening with a load capacity of 40 kg. The other drawers open 85% with a load capacity of 80 kg.

Internal drawer dimensions mm	
Width 460	Depth 612
Outer height mm	Inner height mm
50	35
100	85
150	135
250	235

1. Drawer unit 55/13-1

Drawers	Code
100 x 1	Standard 610 07 001

2. Drawer unit 55/37-1

Drawers	Code
50 x 1, 100 x 1, 150 x 1	Standard 611 07 001

3. Drawer unit 55/37-2

Drawers	Code
100 x 3	Standard 611 07 002

4. Drawer unit 55/66-2

Drawers	Code Standard	Code With base	Code With castors
50 x 2, 100 x 2, 150 x 2	612 07 102	612 07 202	612 07 302



5. Drawer unit 55/66-3

Drawers	Code Standard	Code With base	Code With castors
50 x 1, 100 x 4, 150 x 1	612 07 103	612 07 203	612 07 303



6. Drawer unit 55/66-4

Drawers	Code Standard	Code With base	Code With castors
50 x 2, 100 x 1, 150 x 1, 250 x 1	612 07 104	612 07 204	612 07 304

7. Drawer unit 55/66-8

Drawers	Code Standard	Code With base	Code With castors
100 x 3, 150 x 2	612 07 108	612 07 208	612 07 308



8. Drawer unit 55/66-15

Drawers	Code Standard	Code With base	Code With castors
100 x 6	612 07 115	612 07 215	612 07 315



Drawer unit 55/66 with base is also available with top and rubber mat. Use code W854113-41 together with the drawer unit code to order.

Additional drawer units 55

	55/37-3	55/37-4	55/66-1	55/66-5	55/66-9	55/66-10	55/66-11	55/66-13
Standard	611 07 003	611 07 004	612 07 101	612 07 105	612 07 109	612 07 110	612 07 111	612 07 113
With base	-	-	612 07 201	612 07 205	612 07 209	612 07 210	612 07 211	612 07 213
With castors	-	-	612 07 301	612 07 305	612 07 309	612 07 310	612 07 311	612 07 313
50	-	x 3	x 3	x 1	-	x 2	-	x 4
100	-	-	x 3	x 3	x 2	x 5	x 1	x 1
150	x 2	x 1	x 1	-	x 1	-	-	x 2
250	-	-	-	x 1	x 1	-	x 2	-



More drawer units in our website

Kindly visit Treston website for additional drawer unit 55 models:
treston.com/drawers/drawer-unit-55

Drawer unit 55/66-6 with door

	Code	Code
	Door right	Door left
Standard	612 07 106	612 07 107
With base	612 07 206	612 07 207
With castors	612 07 306	612 07 307

Cabinets include bottom shelf.



Shelves for drawer unit 55/66 with door

Name	Size mm	Max load kg	Code
Pull-out shelf	455 x 612 x 61	80	854 106-49
Shelf	540 x 629 x 35	80	854 114-49

Fastening set for drawer unit 55

Description	Code
With fastening set drawer unit 55 can be fastened on 900 x 1800 mm TP/TPB/TPH benches.	855 056-49

Drawer interiors

Divider Set 1

Model	Code
55/100	873 001-49
55/150&250	873 006-49

3 dividers, 12 middleplates (9x100, 3x150)

Divider Set 2

Model	Code
55/100	873 002-49
55/150&250	873 007-49

2 dividers, 9 middle plates (9x150)

Divider Set 3

Model	Code
55/100	873 003-49
55/150&250	873 008-49

1 divider, 5 middle plates (3x150, 2x300)

Tool troughs 33, 45 and 70 mm

Model	Code
Drawer 55/50	834 122-00

4 x 33 mm, 3 x 45 mm, 2 x 70 mm

Pick up boxes

Model	Code
Drawer 55/100	851 866-00

Includes 21 pick-up boxes with dividers.

Rubber mat for the drawer bottom

Model	Code
Rubber mat 55	852 717-00

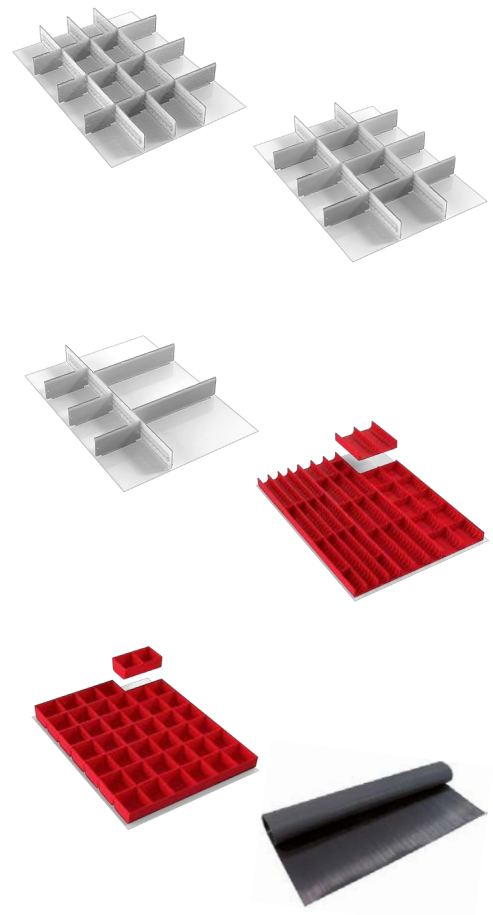

One example of interior solutions shown in picture.

+ For additional divider parts see page 211.

Drawer unit 55 combinations

It is possible to combine two drawer unit 55 frames with the help of a TWIN set (combination 5). The middle plate can be used to stack two drawer units 55 (combinations 1-4).

Combination 1, Code C 612 07 901

Includes	Code
55/66-4	612 07 304
55/37-1	611 07 001
Middle plate	854 103-49

Combination 2, Code C 612 07 902

Includes	Code
55/66-6	612 07 306
55/37-1	611 07 001
Middle plate	854 103-49
Shelf + brackets	854 114-49

Combination 3, Code C 612 07 905

Includes	Code
55/66-4	612 07 204
55/37-1	611 07 001
Middle plate	854 103-49

Combination 4, Code C 612 07 906

Includes	Code
55/66-6	612 07 206
55/37-1	611 07 001
Middle plate	854 103-49
Shelf + brackets	854 114-49

Combination 5, Code C 612 07 903

Includes	Size mm	Code
55/66-4		612 07 104
55/66-6		612 07 106
Twin set		854 108-41
Shelf + brackets		854 114-49
Bench top	1200 x 750	110 995-79

TWIN set

Name	Size mm	Code
Twin set		854 108-41
Bench top	1200 x 750	110 995-79

The Twin set includes four swivel castors Ø100 mm, two of which have brakes and plates to fix two frames together. The top is not included in the pack.

Middle plate

Name	Code
Middle plate	854 103-49



Note! Drawers have separate locks. Serialization can be ordered.

Always remember to lock the drawer unit during transport!

Drawer unit 71

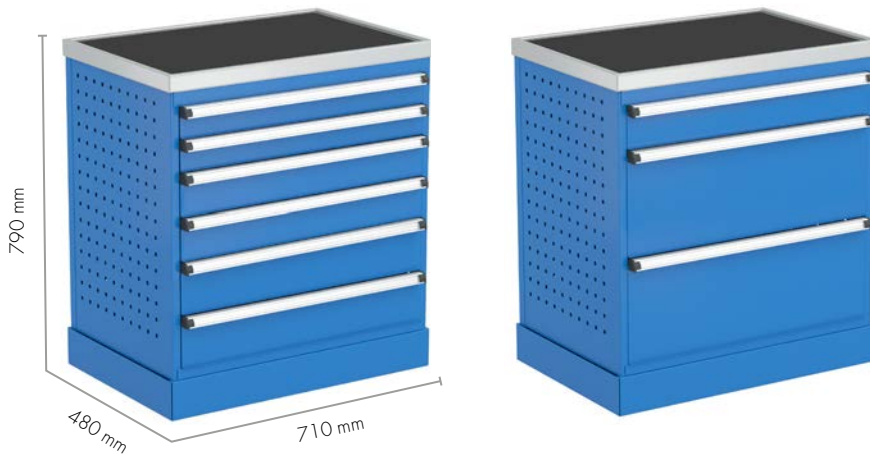

Drawers open 90% and their load capacity is 50 kg.

Internal drawer dimensions mm	
Width 600	Depth 345
Outer height mm	Inner height mm
75	63
100	88
125	113
250	238

Less than 50 cm deep, this drawer unit is ideal for use in narrow spaces, such as in vehicles. The units come with a rubber mat that stops items from sliding on the surface. The drawers have ball bearing runners and safety locking which prevents other drawers from opening while one drawer is open.

This same drawer unit is used in the service trolley with castors. The drawers are opening 90% and their load capacity is 50 kg.

1. Drawer unit 71/79-1

Drawers	Code
75 x 3, 125 x 1, 250 x 1	620 07 001

2. Drawer unit 71/79-2

Drawers	Code
75 x 2, 100 x 2, 125 x 2	620 07 002

3. Drawer unit 71/79-3

Drawers	Code
75 x 1, 100 x 4, 125 x 1	620 07 003

4. Drawer unit 71/79-4

Drawers	Code
75 x 5, 100 x 1, 125 x 1	620 07 004



5. Drawer unit 71/79-5

Drawers	Code
75 x 2, 100 x 2, 250 x 1	620 07 005

6. Drawer unit 71/79-6

Drawers	Code
100 x 1, 250 x 2	620 07 006

7. Drawer unit 71/79-7

Drawers	Code
100 x 1, 125 x 2, 250 x 1	620 07 007

8. Drawer unit 71/79-8

Drawers	Code
100 x 1, 125 x 4	620 07 008

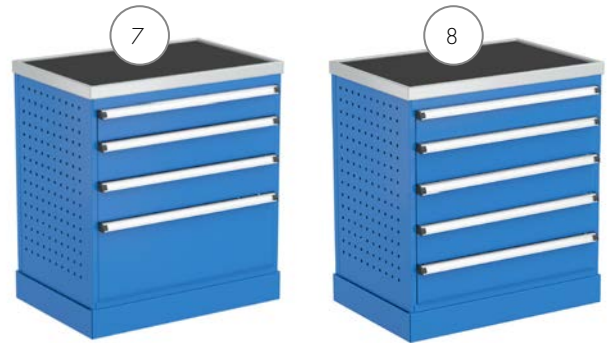

Drawer interiors

Tool troughs 45 and 70 mm

Name	Code
Drawer 71/75	854 066-00
6 x 45 mm, 4 x 70 mm	

Pick up boxes

Name	Code
Drawer 71/75	854 064-00
Includes 16 pick-up boxes with dividers.	

Middle dividers and plates 2

Name	Code
Drawer 71/75	854 069-49
Drawer 71/100	854 070-49
Drawer 71/125	854 070-49
3 x middle divider, 6 x middle plate 150 and 2 x middle plate 300*	

Rubber mat for the drawer bottom

Name	Code
Rubber mat 71	854 078-00

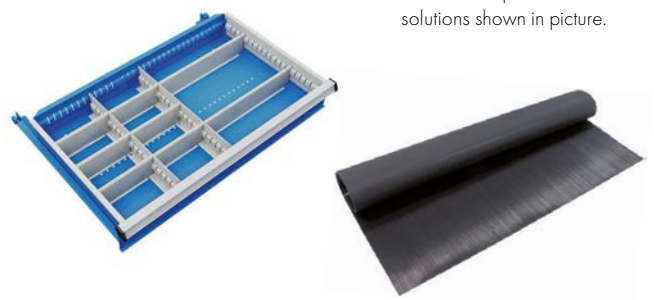
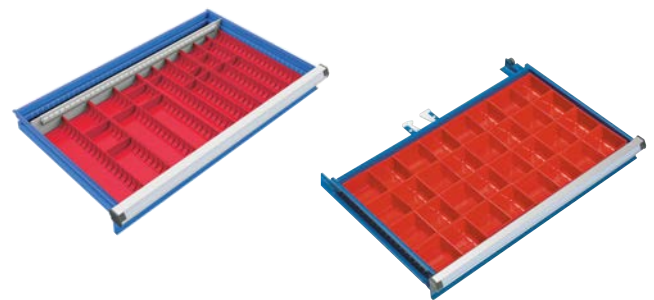

* One example of interior solutions shown in picture.



For additional divider parts see page 211.

Drawer units 70, 90 and 130

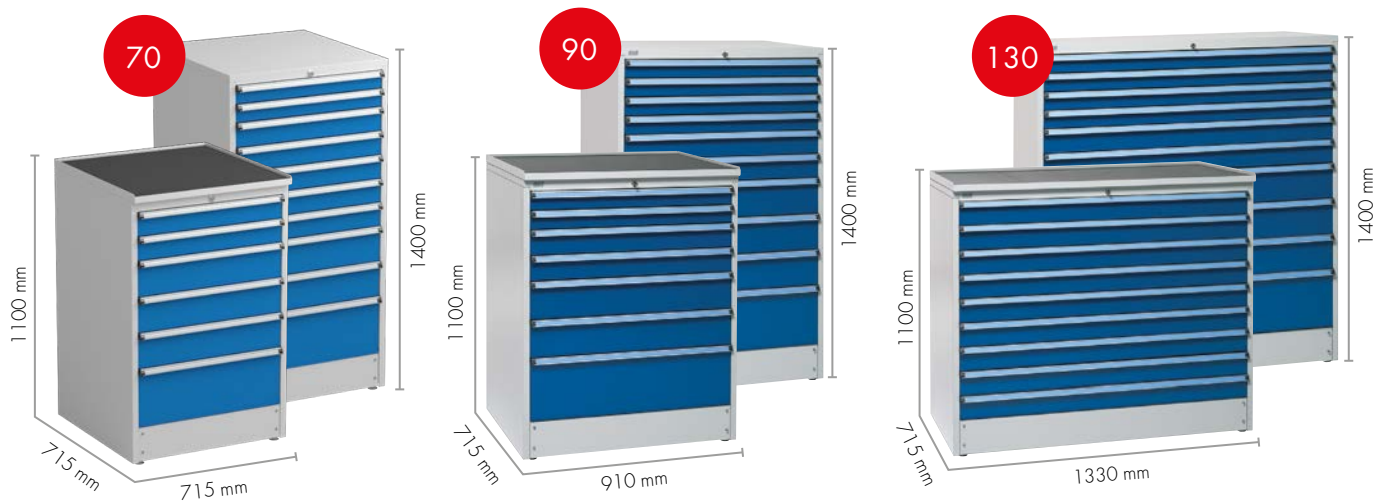

You can fit an amazing number of things in these spacious drawer units. Choose the one that best meets your needs from two heights: 110 and 140 cm. The 110-cm-high drawer units include a cover that doubles as a worktop with a rubber mat.

The safety locking prevents other drawers from opening while one drawer is open. The drawer unit can be moved with a pallet truck or a forklift when the base front plate has been removed. The drawers are fully opening and their load capacity is up to 200 kg.

Drawer units 70, 90 and 130 are also available in grey (code 41 instead of 07, e.g. 613 41 004).





All the drawers are fully opening, also available with a load capacity of up to 200 kg!

The drawer units 70, 90 and 130 all have fully opening drawers. The load capacity of the standard drawers is 75 kg, but all the drawer units are available with drawers that have **a load capacity of 200 kg!**

The drawer units with the load capacity of 200 kg are indicated by a product code having an H in the end (e.g. 613 07 001 H).



The drawer units 70, 90 and 130 can be moved with a pallet truck or a forklift when the base front plate has been removed.



The large drawer units 70, 90 and 130 include levelling screws, which help to level the unit on uneven surfaces.

Drawer unit 70

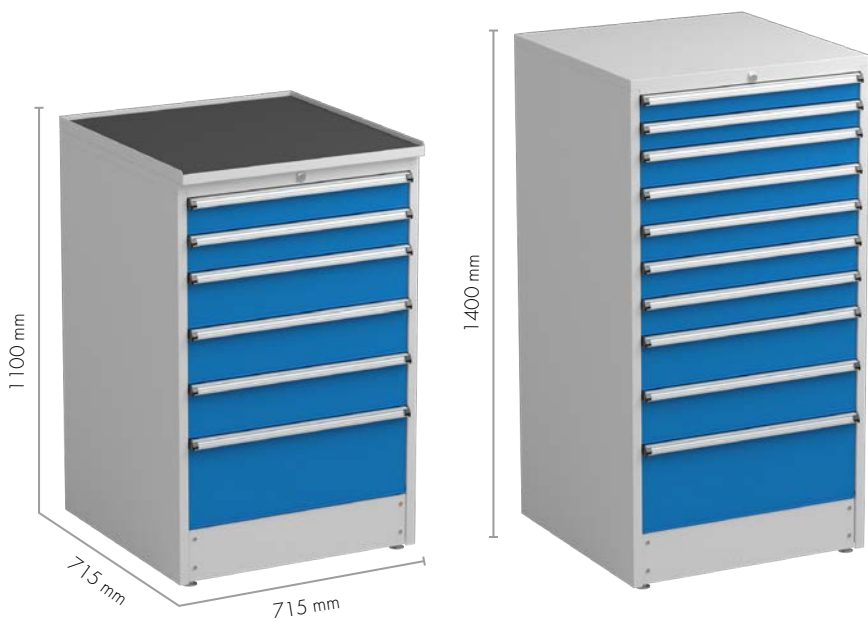

Drawers open 100% and their load capacity is 75 kg or 200 kg.

Internal drawer dimensions mm	
Width 612	Depth 612
Outer height mm	Inner height mm
75	60
100	85
150	135
250	235

1. Drawer unit 70/110-4

Drawers	Code	Code
	75 kg	200 kg
75 x 2, 100 x 2, 150 x 2, 250 x 1	613 07 004	613 07 004 H

2. Drawer unit 70/110-4 (grey)

Drawers	Code	Code
	75 kg	200 kg
75 x 2, 100 x 2, 150 x 2, 250 x 1	613 41 004	613 41 004 H

3. Drawer unit 70/110-12

Drawers	Code	Code
	75 kg	200 kg
75 x 2, 100 x 6, 150 x 1	613 07 012	613 07 012 H

4. Drawer unit 70/110-45

Drawers	Code	Code
	75 kg	200 kg
100 x 4, 250 x 2	613 07 045	613 07 045 H

5. Drawer unit 70/140-1

Drawers	Code	Code
	75 kg	200 kg
75 x 2, 100 x 5, 150 x 2, 250 x 1	616 07 001	616 07 001 H

6. Drawer unit 70/140-3

Drawers	Code	Code
	75 kg	200 kg
100 x 4, 150 x 2, 250 x 2	616 07 003	616 07 003 H

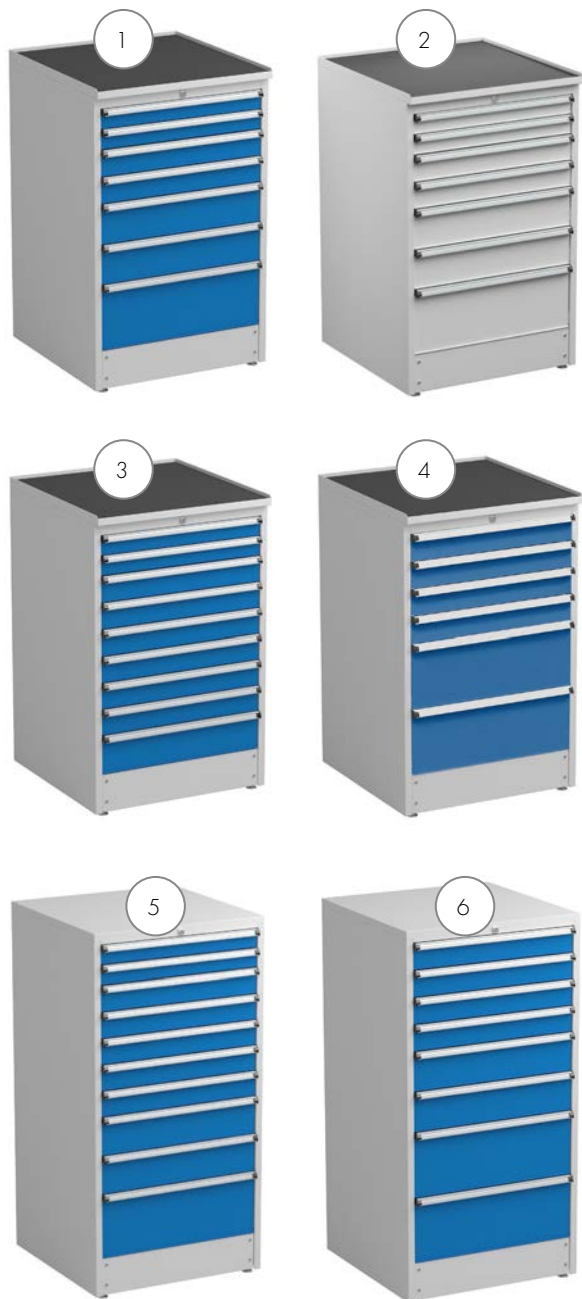

7. Drawer unit 70/140-4

Drawers	Code 75 kg	Code 200 kg
75 x 4, 100 x 2, 150 x 3, 250 x 1	616 07 004	616 07 004 H

8. Drawer unit 70/140-19

Drawers	Code 75 kg	Code 200 kg
75 x 16	616 07 019	616 07 019 H

9. Drawer unit 70/140-23

Drawers	Code 75 kg	Code 200 kg
100 x 8, 150 x 1, 250 x 1	616 07 023	616 07 023 H

10. Drawer unit 70/140-31

Drawers	Code 75 kg	Code 200 kg
100 x 9, 150 x 2	616 07 031	616 07 031 H



Additional drawer units 70/110

	70/110-1	70/110-2	70/110-3	70/110-13	70/110-20	70/110-21	70/110-32	70/110-33
Code (75 kg)	613 07 001	613 07 002	613 07 003	613 07 013	613 07 020	613 07 021	613 07 032	613 07 033
Code (200 kg)	613 07 001 H	613 07 002 H	613 07 003 H	613 07 013 H	613 07 020 H	613 07 021 H	613 07 032 H	613 07 033 H
75	-	x 2	-	-	x 8	-	x 12	-
100	x 2	x 3	x 9	x 6	x 3	-	-	x 1
150	x 3	x 3	-	x 2	-	x 1	-	x 2
250	x 1	-	-	-	-	x 3	-	x 2

Additional drawer units 70/140

	70/140-2	70/140-14	70/140-20	70/140-24	70/140-26	70/140-28	70/140-36	70/140-37
Code (75 kg)	616 07 002	616 07 014	616 07 020	616 07 024	616 07 026	616 07 028	616 07 036	616 07 037
Code (200 kg)	616 07 002 H	616 07 014 H	616 07 020 H	616 07 024 H	616 07 026 H	616 07 028 H	616 07 036 H	616 07 037 H
75	x 2	-	-	-	x 10	x 6	x 6	x 2
100	x 6	x 6	x 3	x 12	x 3	x 3	x 2	-
150	x 3	x 4	x 6	-	x 1	x 3	x 2	x 2
250	-	-	-	-	-	-	x 1	x 3



More drawer units in our website

Kindly visit Treston website for additional drawer unit 70 models:
treston.com/drawers/drawer-unit-70

Drawer interiors

Tool troughs 33 and 45 mm

Name	Code
Drawer 70/50	837 911-00
Drawer 70/75	837 911-00
8 x 33 mm, 6 x 45 mm	

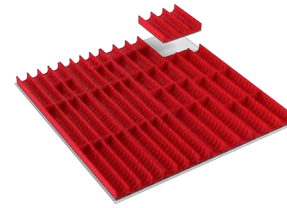

Tool troughs 45 and 70 mm

Name	Code
Drawer 70/50	837 938-00
Drawer 70/75	837 938-00
6 x 45 mm, 4 x 70 mm	

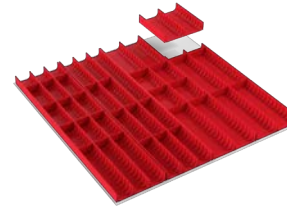

Pick up boxes

Name	Code
Drawer 70/75	851 867-00
Includes 28 pick-up boxes with dividers.	

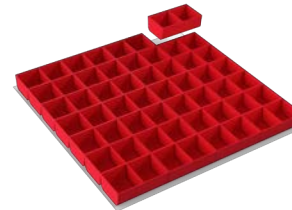

Divider Set 1

Name	Code
70/75	873 011-49
70/100	873 021-49
70/150 & 250	873 031-49
5 dividers, 18 middle plates (18x100)	

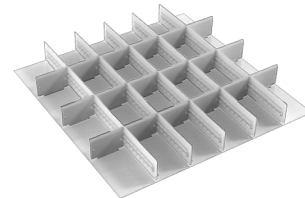

Divider Set 2

Name	Code
70/75	873 012-49
70/100	873 022-49
70/150 & 250	873 032-49
3 dividers, 12 middle plates (12x150)	

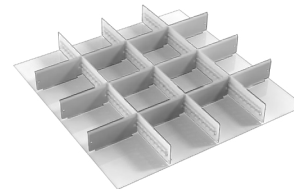

Divider Set 3

Name	Code
70/75	873 013-49
70/100	873 023-49
70/150 & 250	873 033-49
1 divider, 4 middle plates (4x300)	



* One example of interior solutions shown in picture.

Divider Set 4

Name	Code
70/75	873 014-49
70/100	873 024-49
70/150 & 250	873 034-49
4 dividers, 15 middle plates (9x100, 6x150)	

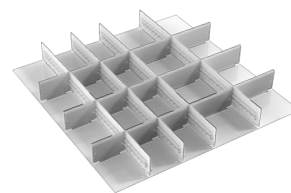
**Divider Set 5**

Name	Code
70/75	873 015-49
70/100	873 025-49
70/150&250	873 035-49
2 dividers, 8 middle plates (6x150, 2x300)	

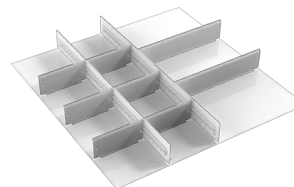
**Divider Set 6**

Name	Code
70/75	873 016-49
70/100	873 026-49
70/150&250	873 036-49
3 dividers, 11 middle plates (9x100, 2x300)	

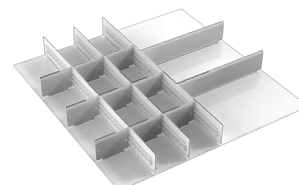
**Rubber mat for the drawer bottom**

Name	Code
Rubber mat 70	852 718-00



For additional divider parts see page 211.

Drawer unit 90



Drawers open 100% and their load capacity is 75 kg or 200 kg.

Internal drawer dimensions mm	
Width 810	Depth 612
Outer height mm	Inner height mm
75	49
100	74
150	124
250	224

1. Drawer unit 90/110-4

Drawers	Code	Code
75 x 2, 100 x 2, 150 x 2, 250 x 1	75 kg 614 07 004	200 kg 614 07 004 H

2. Drawer unit 90/110-4 (grey)

Drawers	Code	Code
75 x 2, 100 x 2, 150 x 2, 250 x 1	75 kg 614 41 004	200 kg 614 41 004 H



3. Drawer unit 90/110-2

Drawers	Code	Code
75 x 2, 100 x 3, 150 x 3	75 kg 614 07 002	200 kg 614 07 002 H

4. Drawer unit 90/110-13

Drawers	Code	Code
100 x 6, 150 x 2	75 kg 614 07 013	200 kg 614 07 013 H



5. Drawer unit 90/110-33

Drawers	Code	Code
100 x 1, 150 x 2, 250 x 2	75 kg 614 07 033	200 kg 614 07 033 H

6. Drawer unit 90/110-34

Drawers	Code	Code
150 x 6	75 kg 614 07 034	200 kg 614 07 034 H



7. Drawer unit 90/140-1

Drawers	Code	Code
	75 kg	200 kg
75 x 2, 100 x 5, 150 x 2, 250 x 1	617 07 001	617 07 001 H

8. Drawer unit 90/140-3

Drawers	Code	Code
	75 kg	200 kg
100 x 4, 150 x 2, 250 x 2	617 07 003	617 07 003 H

9. Drawer unit 90/140-4

Drawers	Code	Code
	75 kg	200 kg
75 x 4, 100 x 2, 150 x 3, 250 x 1	617 07 004	617 07 004 H

10. Drawer unit 90/140-19

Drawers	Code	Code
	75 kg	200 kg
75 x 16	617 07 019	617 07 019 H



Additional drawer units 90/110

	90/110-1	90/110-3	90/110-20	90/110-21	90/110-43	90/110-44	90/110-45	90/110-46
Code (75 kg)	614 07 001	614 07 003	614 07 020	614 07 021	614 07 043	614 07 044	614 07 045	614 07 046
Code (200 kg)	614 07 001 H	614 07 003 H	614 07 020 H	614 07 021 H	614 07 043 H	614 07 044 H	614 07 045 H	614 07 046 H
75	-	-	x 8	-	x 2	-	-	x 8
100	x 2	x 9	x 3	-	-	x 3	x 4	-
150	x 3	-	-	x 1	-	x 4	-	x 2
250	x 1	-	-	x 3	x 3	-	x 2	-

Additional drawer units 90/140

	90/140-2	90/140-14	90/140-23	90/140-24	90/140-26	90/140-28	90/140-31	90/140-34
Code (75 kg)	617 07 002	617 07 014	617 07 023	617 07 024	617 07 026	617 07 028	617 07 031	617 07 034
Code (200 kg)	617 07 002 H	617 07 014 H	617 07 023 H	617 07 024 H	617 07 026 H	617 07 028 H	617 07 031 H	617 07 034 H
75	x 2	-	-	-	x 10	x 6	-	-
100	x 6	x 6	x 8	x 12	x 3	x 3	x 9	-
150	x 3	x 4	x 1	-	x 1	x 3	x 2	x 8
250	-	-	x 1	-	-	-	-	-



More drawer units in our website

Kindly visit Treston website for additional drawer unit 90 models:
treston.com/drawers/drawer-unit-90

Drawer interiors

Tool troughs 33 and 45 mm

Name	Code
Drawer 90/75	837 913-00
8 x 33 mm, 9 x 45 mm	
Tool troughs leave 50 mm free space on one side of the drawer.	

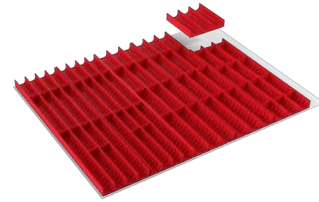

Tool troughs 45 and 70 mm

Name	Code
Drawer 90/75	837 914-00
9 x 45 mm, 4 x 70 mm	
Tool troughs leave 50 mm free space on one side of the drawer.	

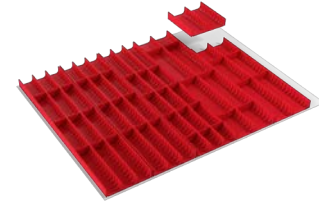

Pick up boxes

Name	Code
Drawer 90/75	851 870-00
Includes 35 pick-up boxes with dividers.	

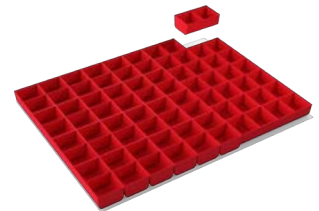

Divider Set 1

Name	Code
90/75	873 041-49
90/100	873 051-49
90/150 & 250	873 061-49
7 dividers, 24 middle plates (24x100)	

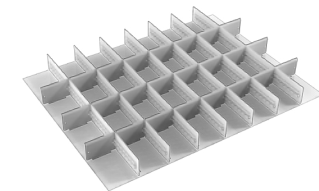

Divider Set 2

Name	Code
90/75	873 042-49
90/100	873 052-49
90/150 & 250	873 062-49
6 dividers, 21 middle plates (15x100, 6x150)	

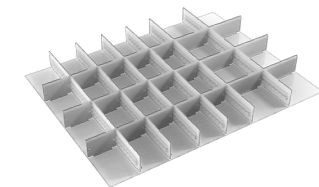

Divider Set 3

Name	Code
90/75	873 043-49
90/100	873 053-49
90/150 & 250	873 063-49
5 dividers, 17 middle plates (15x100, 2x300)	

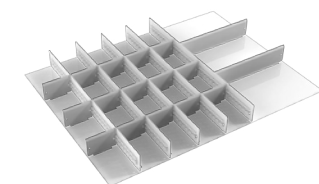

Divider Set 4

Name	Code
90/75	873 044-49
90/100	873 054-49
90/150 & 250	873 064-49
4 dividers, 14 middle plates (6x100, 6x150, 2x300)	

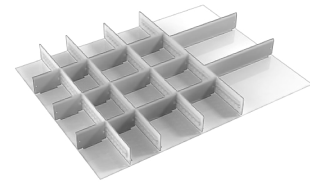
**Divider Set 5**

Name	Code
90/75	873 045-49
90/100	873 055-49
90/150 & 250	873 065-49
3 dividers, 10 middle plates (6x100, 4x300)	

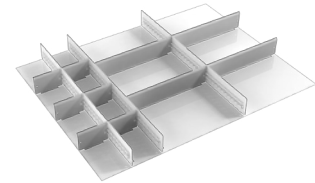
**Divider Set 6**

Name	Code
90/75	873 046-49
90/100	873 056-49
90/150 & 250	873 066-49
5 dividers, 18 middle plates (6x100, 12x150)	

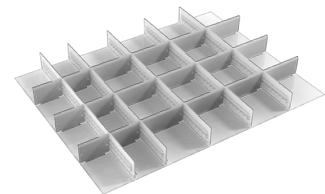
**Divider Set 7**

Name	Code
90/75	873 047-49
90/100	873 057-49
90/150 & 250	873 067-49
4 middle plates (4x800)	

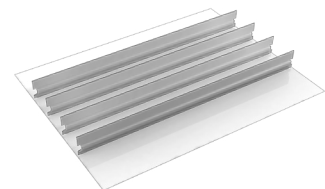
**Rubber mat for the drawer bottom**

Name	Code
Rubber mat 90	854 080-00



For additional divider parts see page 211.

Drawer unit 130

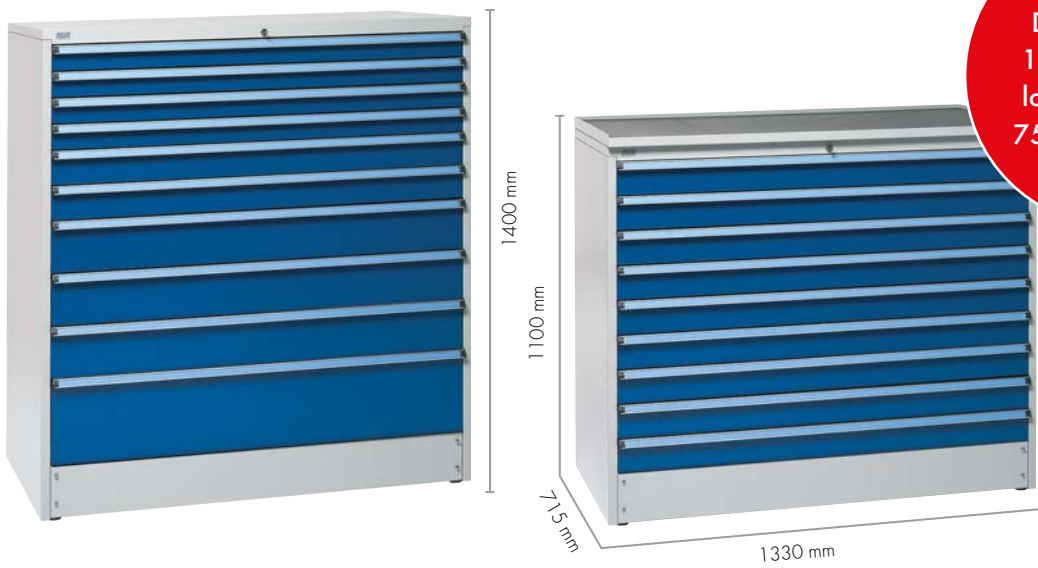

Drawers open 100% and their load capacity is 75 kg or 200 kg.

Internal drawer dimensions mm	
Width 1226	Depth 612
Outer height mm	Inner height mm
75	49
100	74
150	124
250	224

1. Drawer unit 130/110-1

Drawers	Code	Code
	75 kg	200 kg
100 x 2, 150 x 3, 250 x 1	615 07 001	615 07 001 H



2. Drawer unit 130/110-3

Drawers	Code	Code
	75 kg	200 kg
100 x 9	615 07 003	615 07 003 H

3. Drawer unit 130/110-4

Drawers	Code	Code
	75 kg	200 kg
75 x 2, 100 x 2, 150 x 2, 250 x 1	615 07 004	615 07 004 H



4. Drawer unit 130/110-4 (grey)

Drawers	Code	Code
	75 kg	200 kg
75 x 2, 100 x 2, 150 x 2, 250 x 1	615 41 004	615 41 004 H

5. Drawer unit 130/110-34

Drawers	Code	Code
	75 kg	200 kg
150 x 6	615 07 034	615 07 034 H



6. Drawer unit 130/140-1

Drawers	Code	Code
	75 kg	200 kg
75 x 2, 100 x 5, 150 x 2, 250 x 1	618 07 001	618 07 001 H

7. Drawer unit 130/140-19

Drawers	Code 75 kg	Code 200 kg
75 x 16	618 07 019	618 07 019 H

8. Drawer unit 130/140-31

Drawers	Code 75 kg	Code 200 kg
100 x 9, 150 x 2	618 07 031	618 07 031 H

9. Drawer unit 130/140-34

Drawers	Code 75 kg	Code 200 kg
150 x 8	618 07 034	618 07 034 H

10. Drawer unit 130/140-42

Drawers	Code 75 kg	Code 200 kg
100 x 1, 150 x 4, 250 x 2	618 07 042	618 07 042 H



Additional drawer units 130/110

	130/110-2	130/110-13	130/110-20	130/110-21	130/110-33	130/110-43	130/110-44	130/110-45
Code (75 kg)	615 07 002	615 07 013	615 07 020	615 07 021	615 07 033	615 07 043	615 07 044	615 07 045
Code (200 kg)	615 07 002 H	615 07 013 H	615 07 020 H	615 07 021 H	615 07 033 H	615 07 043 H	615 07 044 H	615 07 045 H
75	x 2	-	x 8	-	-	x 2	-	-
100	x 3	x 6	x 3	-	x 1	-	x 3	x 4
150	x 3	x 2	-	x 1	x 2	-	x 4	-
250	-	-	-	x 3	x 2	x 3	-	x 2

Additional drawer units 130/140

	130/140-2	130/140-3	130/140-4	130/140-23	130/140-24	130/140-26	130/140-28	130/140-35
Code (75 kg)	618 07 002	618 07 003	618 07 004	618 07 023	618 07 024	618 07 026	618 07 028	618 07 035
Code (200 kg)	618 07 002 H	618 07 003 H	618 07 004 H	618 07 023 H	618 07 024 H	618 07 026 H	618 07 028 H	618 07 035 H
75	x 2	-	x 4	-	-	x 10	x 6	x 8
100	x 6	x 4	x 2	x 8	x 12	x 3	x 3	x 6
150	x 3	x 2	x 3	x 1	-	x 1	x 3	-
250	-	x 2	x 1	x 1	-	-	-	-



More drawer unit in our website

Kindly visit Treston website for additional drawer unit 130 models:
treston.com/drawers/drawer-unit-130

Drawer interiors

Divider Set 1

Name	Code
130/75	873 071-49
130/100	873 081-49
130/150 & 250	873 091-49
11 dividers, 36 middle plates (36x100)	

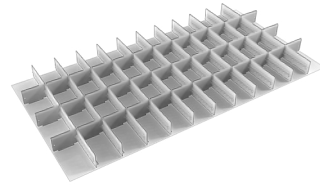

Divider Set 2

Name	Code
130/75	873 072-49
130/100	873 082-49
130/150 & 250	873 092-49
9 dividers, 30 middle plates (18x100, 12x150)	

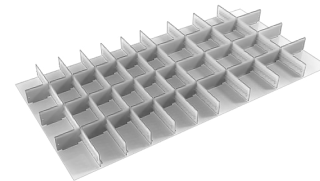

Divider Set 3

Name	Code
130/75	873 073-49
130/100	873 083-49
130/150 & 250	873 093-49
7 dividers, 22 middle plates (18x100, 4x300)	

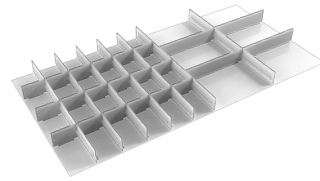

Divider Set 4

Name	Code
130/75	873 074-49
130/100	873 084-49
130/150 & 250	873 094-49
7 dividers, 23 middle plates (9x100, 12x150, 2x300)	

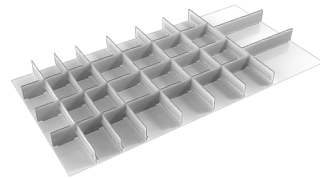

Divider Set 5

Name	Code
130/75	873 075-49
130/100	873 085-49
130/150 & 250	873 095-49
7 dividers, 16 middle plates (16x150)	

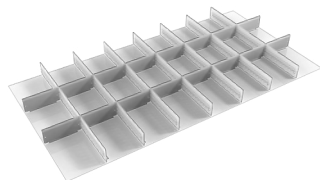

Divider Set 6

Name	Code
130/75	873 076-49
130/100	873 086-49
130/150 & 250	873 096-49
5 dividers, 16 middle plates (12x150, 4x300)	

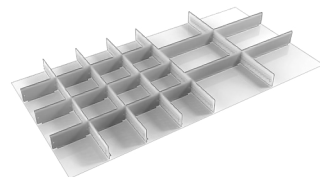

* One example of interior solutions shown in picture.

Divider Set 7

Name	Code
130/75	873 077-49
130/100	873 087-49
130/150 & 250	873 097-49
3 dividers, 12 middle plates (12x300)	

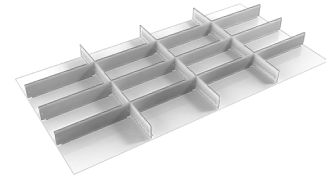
**Divider Set 8**

Name	Code
130/75	873 078-49
130/100	873 088-49
130/150 & 250	873 098-49
4 middle plates (4x1200)	

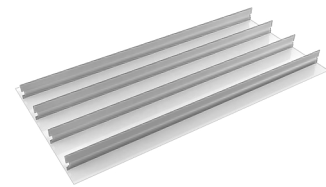
**Tool troughs 33 and 45 mm**

Name	Code
Drawer 130/75	837 912-00
16 x 33 mm, 12 x 45 mm	

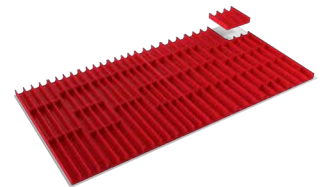
**Tool troughs 45 and 70 mm**

Name	Code
Drawer 130/75	837 939-00
12 x 45 mm, 8 x 70 mm	

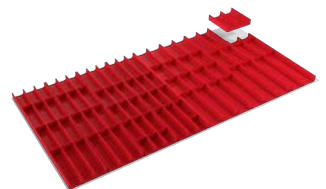
**Pick up boxes**

Name	Code
Drawer 130/75	851 872-00
Includes 56 pick-up boxes with dividers.	

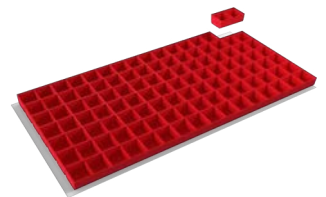
**Rubber mat for the drawer bottom**

Name	Code
Rubber mat 130	854 082-00



For additional divider parts see page 211.



7. Storage systems

FiFo Flow Rack



Treston FiFo Flow Rack is a flexible shelving, storage and picking solution. It brings the items from the warehouse nearby the production, assembly or packing station. Ensures the needed parts are at hand and no time is wasted searching for items, supporting LEAN operations. FiFo (First in First out) flow ensures the oldest components are available first and the inventory is at a good level. Reduce errors and allow personnel to concentrate on the work at hand improving quality.



No tools needed to easily modify for different size bins and items.



Quick and easy to assemble and adjust. Only an allen key needed to assemble. An included magnetic spirit level helps when levelling the feet with a wrench.



Easy to accessorize, wide selection of accessories. Can be turned into a workstation with an additional shelf.



FiFo Flow Rack

Name	Suitability of bins	Module	Size W x D x H mm	Max load kg	Code ESD
1 FiFo Flow Rack	24 pcs Treston stacking bins 1940 or similar.	M900	933 x 805 x 1860	700	TFR900-49
	24 pcs Treston stacking bins 3040, 24 pcs 300 x 400 euroboxes or similar.	M1350	1385 x 805 x 1860	700	TFR1350-49
2 FiFo Flow Rack, rear extension	24 pcs Treston stacking bins 1940 or similar.	M900	933 x 735 x 1860	700	TFR900RE-49
	24 pcs Treston stacking bins 3040, 12 pcs 300 x 400 euroboxes or similar.	M1350	1385 x 735 x 1860	700	TFR1350RE-49
3 FiFo Flow Rack, side extension	24 pcs Treston stacking bins 1940 or similar	M900	933 x 805 x 1860	700	TFR900SE-49
	24 pcs Treston stacking bins 3040, 24 pcs 300 x 400 euroboxes or similar.	M1350	1385 x 805 x 1860	700	TFR1350SE-49
4 FiFo Flow Rack, side-rear extension	24 pcs Treston stacking bins 1940 or similar.	M900	933 x 735 x 1860	700	TFR900SRE-49
	24 pcs Treston stacking bins 3040, 12 pcs 300 x 400 euroboxes or similar.	M1350	1385 x 735 x 1860	700	TFR1350SRE-49

Rack includes 3 roller tops which are adjustable without any tools. Each roller top includes 8 pcs roller profiles and 3 pcs guide plates.

Many other bin size options are suitable by adding or removing roller profiles and guide plates.

FiFo Flow Rack with steel shelves

Name	Suitability of bins	Module	Size W x D x H mm	Max load kg	Code ESD
FiFo Flow Rack, steel shelves	24 pcs Treston stacking bins 1940 or similar.	M900	933 x 805 x 1860	700	TFR900SS-49
	32 pcs Treston stacking bins 3040, 300 x 400 euroboxes or similar. Alternatively 48 pcs Treston stacking bins 1940 or similar.	M1350	1385 x 805 x 1860	700	TFR1350SS-49

The rack includes 4 steel shelves which are adjustable.



Extendable with rear and side modules – with as many modules as needed.



FiFo Flow Rack accessories

Name	Description	Module	Size W x D x H mm	Max load kg	Code ESD
1 Roller top	An extra roller top increases the space for the bins in the FiFo flow rack. Includes fixing brackets.	M900 M1350	852 x 766 x 105 1279 x 766 x 105	220 220	TFRRT900-49 TFRRT1350-49
2 Roller top, rear extension	An extra roller top of rear extension increases the space for the bins in rear extension FiFo flow rack. Includes fixing brackets.	M900 M1350	852 x 766 x 105 1279 x 766 x 105	220 220	TFRRT900RE-49 TFRRT1350RE-49
3 Additional shelf for FiFo Flow Rack with steel shelves	An extra steel shelf increases the space for the bins in steel shelves version of FiFo flow rack. Includes fixing brackets.	M900 M1350	852 x 789 x 53 1310 x 789 x 52	220 220	TFRAS900-49 TFRAS1350-49
4 Roller profile set, 4 pcs Guide plate set, 3 pcs	Extra roller profiles and guide plates allow you to increase storage space by using smaller bins in your FiFo flow rack.		29 x 734 x 37 2 x 718 x 70		TFRRS-49 TFRGP-49
5 Perforated panel set, 2 pcs (left, right)	With perforated panels you can cover both side of FiFo flow rack. With the panel hooks you can use the side panels easily as tool storage as well.		15 x 736 x 812		TFRPP-49
6 Castor set ESD*	Castor set for Treston FiFo Flow Rack M900 ESD Castor set for Treston FiFo Flow Rack M1350 ESD				TFR900CS-49 TFR1350CS-49

* Also non-ESD castors available, use code TFR900CS-41 / TFR1350CS-41.

All Treston accessories available for upright tubes are suitable for FiFo Flow Rack.



Watch the 2 min animation showcasing the features:
<https://vimeo.com/427987809>



Shelves and cabinets



Shelves and cabinets help keep the workplace in good order. During selection the space available and load capacity required must be taken into account. Shelving units are also excellent as room dividers. ESD protection is also available.

Extended tool life

The service life and condition of tools can be significantly improved through their appropriate storage. They can be stored in their own places, protected from dust and dirt, in a locked cabinet.

A versatile storage solution is created by using suitable accessories

An open shelf is not always the best way to store things. Tools, expensive equipment, and small items need another type of solution. Through using lockable drawers or adding doors and panels, an open shelving system is turned into a versatile storage solution. Drawers can be fitted with a variety of interior combinations, to suit the tools stored in them.

Storage system is modifiable

A storage system is built around the basic component: extension parts, doors, screens, and other accessories can be added to create an efficient overall solution. In addition the shelf heights can easily be adjusted as needed. Even the load capacity can be increased by adding additional supports.

Heavy storage system is designed for heavy items

When the items are heavy, shelves need to be very strong as well. Computer servers or large measurement instruments can be surprisingly heavy. A heavy storage system is designed for load capacities of up to 400 kg/shelf.



Industrial cabinets allow for a tidy, efficient working environment

No unnecessary time should be spent looking for tools and materials. This interrupts work and causes stress. In a well-equipped cabinet, everything is where it should be. A ready-assembled cabinet is easy to move to the most convenient location. There are levelling screws under the cabinet. This makes it easy to adjust the cabinet so that it stands straight on uneven surfaces. Most module-750 and -500 accessories, such as shelves, drawer units, perforated panels, and pull-out shelves, can be used in selecting accessories for the cabinet.

Shelving system

Shelving system can be built as a combination of cabinets and shelves and you can use it as a space divider. The storage system is available in two standard heights: 200 cm and 240 cm and two widths: 80 cm and 100 cm.

Standard bays

Name	Size W x D mm	Code
Standard bay 80/30/200	824 x 300 x 2000	C 313 49 001P
Standard bay 80/40/200	824 x 400 x 2000	C 314 49 001P
Standard bay 100/30/200	1024 x 300 x 2000	C 313 49 002P
Standard bay 100/40/200	1024 x 400 x 2000	C 314 49 003P
Standard bay 100/50/200	1024 x 500 x 2000	C 315 49 001P
Standard bay 100/60/200	1024 x 600 x 2000	C 316 49 001P
Standard bay 80/40/240	824 x 400 x 2400	C 314 49 002P
Standard bay 100/40/240	1024 x 400 x 2400	C 314 49 004P
Standard bay 100/50/240	1024 x 500 x 2400	C 315 49 002P
Standard bay 100/60/240	1024 x 600 x 2400	C 316 49 002P

Extension bays

Name	Size W x D mm	Code
Extension bay 80/30/200	804 x 300 x 2000	C 323 49 001P
Extension bay 80/40/200	804 x 400 x 2000	C 324 49 001P
Extension bay 100/30/200	1004 x 300 x 2000	C 323 49 002P
Extension bay 100/40/200	1004 x 400 x 2000	C 324 49 003P
Extension bay 100/50/200	1004 x 500 x 2000	C 325 49 001P
Extension bay 100/60/200	1004 x 600 x 2000	C 326 49 001P
Extension bay 80/40/240	804 x 400 x 2400	C 324 49 002P
Extension bay 100/40/240	1004 x 400 x 2400	C 324 49 004P
Extension bay 100/50/240	1004 x 500 x 2400	C 325 49 002P
Extension bay 100/60/240	1004 x 600 x 2400	C 326 49 002P

All standard and extension bays include 6 shelves. For additional shelves see page 166.



The W x D x H rule

All our dimensions follow a WDH rule, where the first dimension is the width (W), the middle the depth (D), and the last the height (H).

Combination name

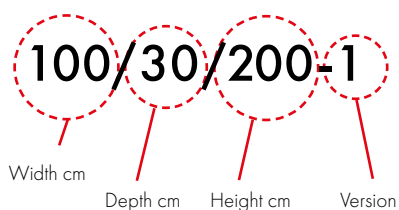

Load capacity

1000 kg/bay

width 824 mm

150 kg/shelf

width 1024 mm

150 kg/shelf

Shelving system combinations

100/30/200-8 C 340 07 108

Qty	Name	Size mm	Code
3	End frame/open	300 x 2000	830 615-49
8	Shelf+brackets	1000 x 300	852 175-49
4	Perforated panel	983 x 500	852 145-07
2	Cross support pair 1000		852 176-49



100/40/200-1 C 344 07 001

Qty	Name	Size mm	Code
1	Cabinet 100/40/200	1030 x 430 x 2010	C 344 07 000
4	Shelf	1000 x 400	852 231-49



100/40/200-4 C 344 07 004

Qty	Name	Size mm	Code
1	Cabinet 100/40/200	1030 x 430 x 2010	C 344 07 000
2	Shelf	1000 x 400	852 231-49
2	Perforated panel	983 x 500	852 145-07
3	Drawer 400	920 x 345 x 107	834 513-49



100/40/200-9 C 340 07 109

Qty	Name	Size mm	Code
2	End frame/open	400 x 2000	830 895-49
14	Shelf+brackets	1000 x 400	852 231-49
2	Cross support pair 1000		852 176-49
2	Perforated panel	983 x 500	852 145-07
1	Cabinet 100/40/200	1030 x 430 x 2010	C 344 07 000



Move with a pallet truck

The cabinet can be moved with a pallet truck or a forklift when the plinth front panel has been removed. Cabinets are equipped with adjustment screws.

Shelving system includes a wide range of different parts which can be used to create a fully tailor-made solution.

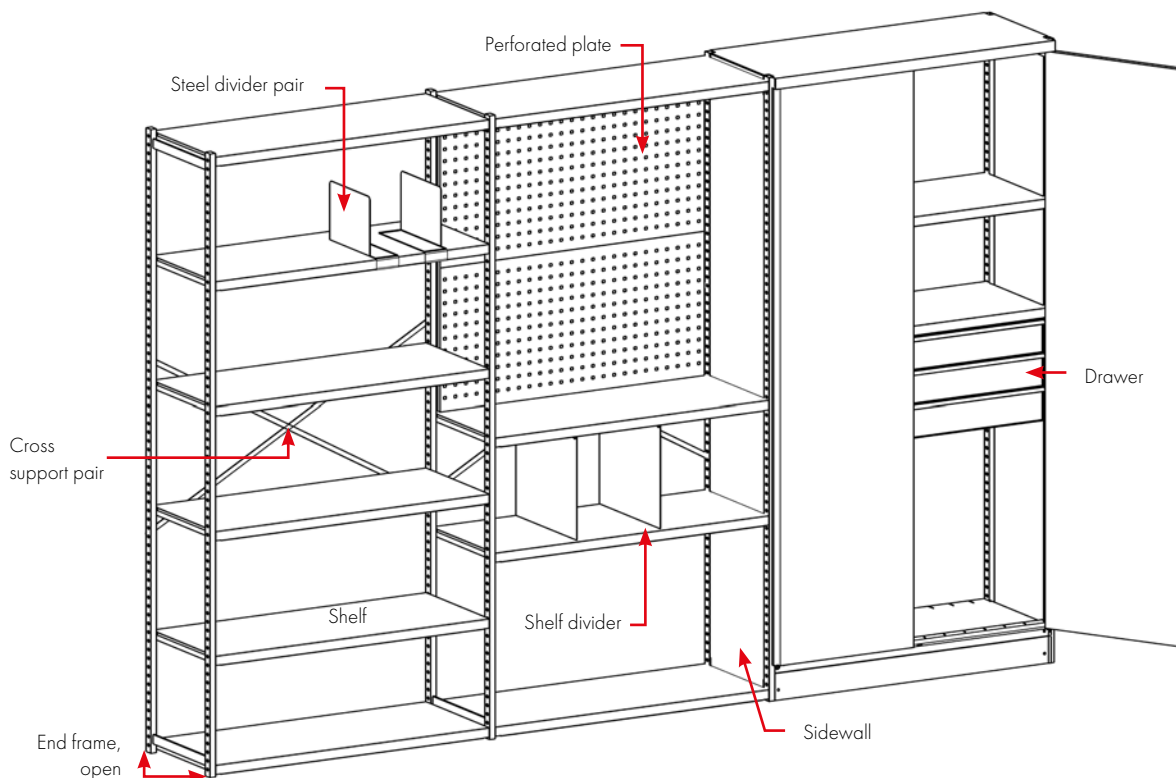

Shelving system components

Name	Size D x H mm	Code
End frame, open	300 x 2000	830 615-49
End frame, open	400 x 2000	830 895-49
Sidewall	400 x 2000	859 440-49
End frame, open	500 x 2000	851 719-49
Sidewall	500 x 2000	859 450-49
End frame, open	600 x 2000	851 725-49
Sidewall	600 x 2000	859 460-49
End frame, open	400 x 2400	851 717-49
End frame, open	500 x 2400	851 721-49
End frame, open	600 x 2400	851 724-49
Cross support pair 1000		852 176-49
Cabinet 100/40/200	1030 x 430 x 2010	C 344 07 000
Cabinet 100/50/200	1030 x 530 x 2010	C 345 07 000
Cabinet 100/60/200	1030 x 630 x 2010	C 346 07 000
Back wall 1000	1000 x 2000	859 447-49
Perforated end plate 400*	340 x 2000	830 917-07
Screw set (fixing back to back)		838 440-51
Perforated panel 1000	983 x 500	852 145-07
Additional support for shelf 1000		852 267-49

* suitable for End frame open 400 x 2000.

Cabinets supplied in parts.

Shelves

Name	Size W x D mm	Max load kg	Code
Shelf	800 x 300	150	852 235-49
Shelf	800 x 400	150	852 234-49
Shelf	1000 x 300	150	852 175-49
Shelf	1000 x 400	150	852 231-49
Shelf	1000 x 500	150	852 185-49
Shelf	1000 x 600	150	852 187-49

Brackets included.

Shelf dividers

Name	Size D x H mm	Code
Steel divider pair	285 x 190	861 116-49
Steel divider pair	385 x 190	861 118-49

Drawers and interior combinations

Name	Size W x D x H mm	Max load kg	Code
Drawer 100/100, for 400 deep cabinet	920 x 345 x 107	30	834 513-49
Drawer 100/100, for 500 deep cabinet	920 x 345 x 107	30	834 514-49
1 Middle divider and middle plates			834 507-49
2 Middle divider and middle plates			834 508-49
3 Middle divider and middle plates			834 509-49
4 Pick up boxes			834 512-00

Drawers also suitable for shelving cabinets on page 170.

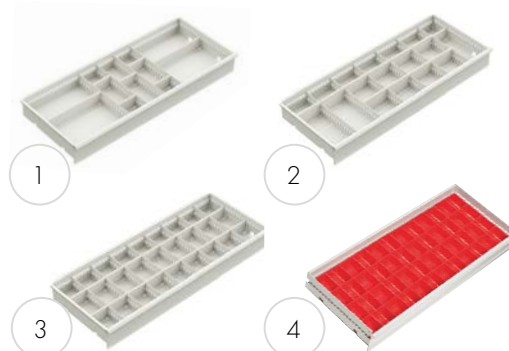

Heavy shelving system

Heavy shelving system is suitable for large and heavy items. The shelf load capacity is 400 kg and the shelf depth is 70 cm. It can be built as a combination of cabinets, drawers and shelves. The heavy storage system comes in one standard height of 200 cm and two widths: 75 cm and 95 cm.

1. Standard bays

Name	Size W x D x H mm	Code
Standard bay, open	750 x 714 x 2000	C 375 49 001
Standard bay, closed*	750 x 714 x 2000	C 376 49 001
Standard bay, open	950 x 714 x 2000	C 395 49 001
Standard bay, closed*	950 x 714 x 2000	C 396 49 001

*The standard bay, closed, includes back sheet and closed ends.

2. Extension bays

Name	Size W x D x H mm	Code
Extension bay, open	705 x 714 x 2000	C 377 49 001
Extension bay, closed*	705 x 714 x 2000	C 378 49 001
Extension bay, open	905 x 714 x 2000	C 397 49 001
Extension bay, closed*	905 x 714 x 2000	C 398 49 001

*The extension bay, closed, includes back sheet and closed end.



All standard and extension bays include 6 shelves.



The W x D x H rule

All our dimensions follow a WDH rule, where the first dimension is the width (W), the middle the depth (D), and the last the height (H).

Load capacity

2000 kg/bay

width 750 mm



400 kg/shelf

width 950 mm



350 kg/shelf

Heavy shelving system combinations

95/200-1 C 395 49 001

Qty	Name	Size mm	Code
2	End frame/open	714 x 2000	852 002-49
6	Shelf 90	860 x 714	852 012-49
1	Cross support pair		851 671-49

75/200-2 C 377 07 002

Qty	Name	Size mm	Code
2	Base/top 70	660 x 714	852 004-49
1	Back sheet 70	740 x 1990	852 009-49
2	End frame/closed	714 x 2000	852 001-49
5	Shelf 70	660 x 714	852 003-49
1	Door pair	700 x 2000	852 000-07

75/200-28

Qty	Name	Size mm	Code
1	Locking shelf	660 x 714	852 007-49
1	End frame/open	714 x 2000	852 002-49
4	Base/top 70	660 x 714	852 004-49
7	Shelf 70	660 x 714	852 003-49
1	Locking element		851 675-49
2	End frame/closed	714 x 2000	852 001-49
3	Drawer 70/50	612 x 612 x 50	833 967-07
2	Drawer 70/100	612 x 612 x 100	833 975-07
2	Drawer 70/150	612 x 612 x 150	833 983-07
1	Drawer 70/250	612 x 612 x 250	833 991-07
1	Back sheet 70	740 x 1990	852 009-49

75/200-9

Qty	Name	Size mm	Code
1	Locking shelf	660 x 714	852 007-49
4	Base/top 70	660 x 714	852 004-49
7	Shelf 70	660 x 714	852 003-49
3	End frame/closed	714 x 2000	852 001-49
3	Drawer 70/50	612 x 612 x 50	833 967-07
2	Drawer 70/100	612 x 612 x 100	833 975-07
2	Drawer 70/150	612 x 612 x 150	833 983-07
1	Drawer 70/250	612 x 612 x 250	833 991-07
2	Back sheet 70	740 x 1990	852 009-49
1	Door pair	700 x 2000	852 000-07
1	Locking element		851 675-49



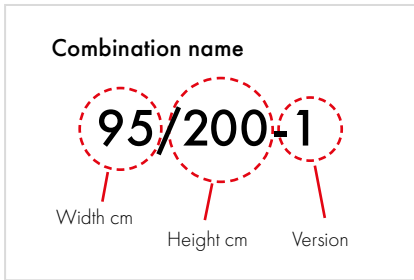

Heavy shelving system includes a wide range of different parts which can be used to create a fully tailor-made solution.

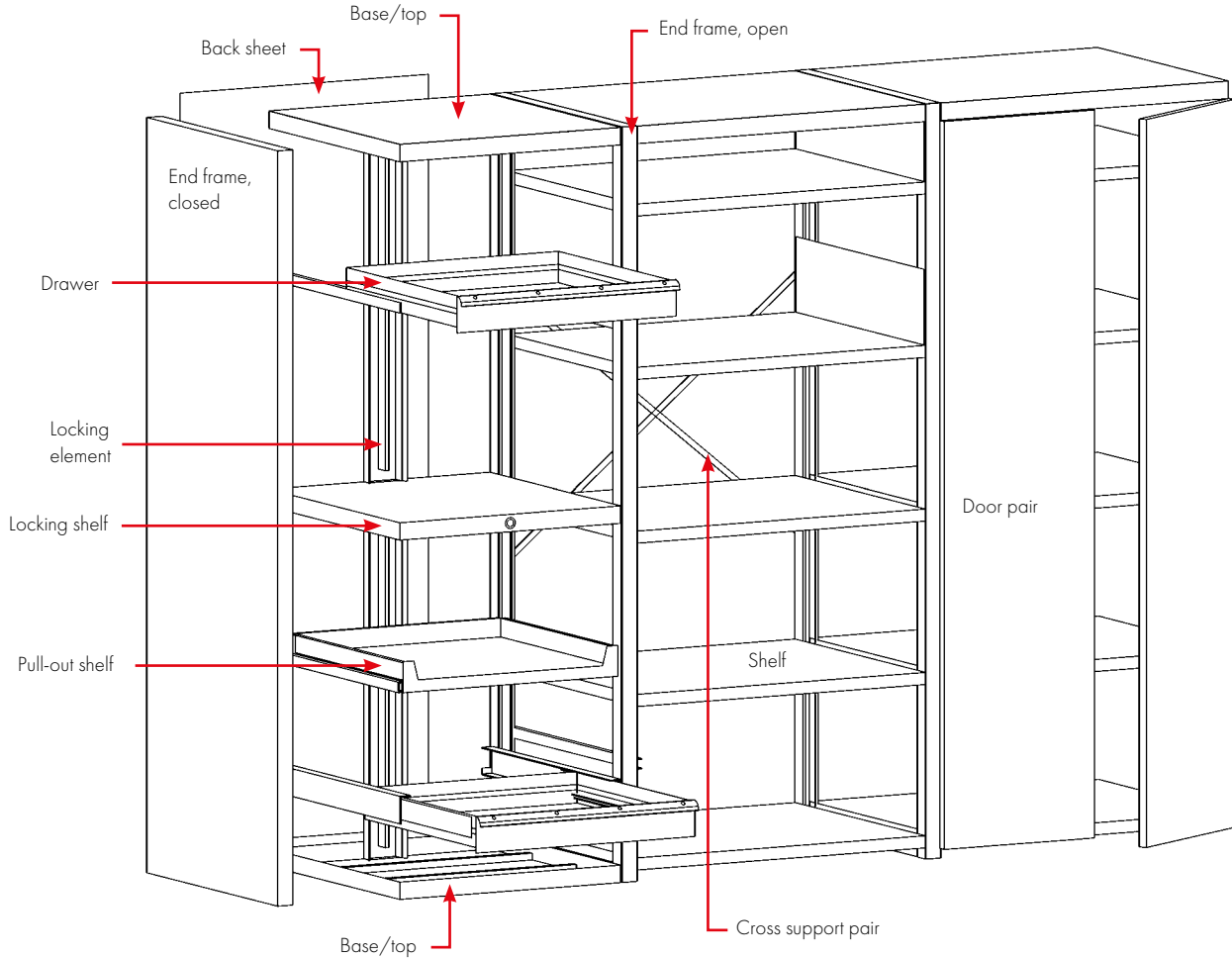

Heavy shelving system components

Name	Size W x D mm	Max load kg	Code
End frame/open	714 x 2000		852 002-49
End frame/closed	714 x 2000		852 001-49
Base/top 70	660 x 714		852 004-49
Base/top 90	860 x 714		852 013-49
Cross support pair			851 671-49
Back sheet 70	740 x 1990		852 009-49
Back sheet 90	940 x 1990		852 016-49
Shelf 70	660 x 714	400	852 003-49
Shelf 90	860 x 714	350	852 012-49
Door pair*	700 x 2000		852 000-07
Door pair*	900 x 2000		852 011-07
Locking shelf 70*	660 x 714		852 007-49
Locking shelf 90*	860 x 714		852 015-49
Locking element	1000		851 675-49

*Door/locking shelf equipped with lock

Heavy shelving system drawers

Name	Size W x D mm	Effective height mm	Max load kg	Opens %	Code
Drawer 70/75	612 x 612 x 75	60	75	100	833 401-07
Drawer 70/100	612 x 612 x 100	85	75	100	833 975-07
Drawer 70/150	612 x 612 x 150	135	75	100	833 983-07
Drawer 70/250	612 x 612 x 250	235	75	100	833 991-07
Pull-out shelf 70	612 x 612 x 85		75	100	852 017-07
Pull-out shelf 90	860 x 612 x 85		75	100	852 019-07
Drawer 90/75	860 x 612 x 75	49	75	100	854 262-07
Drawer 90/100	860 x 612 x 100	74	75	100	854 246-07
Drawer 90/150	860 x 612 x 150	124	75	100	854 248-07
Drawer 90/250	860 x 612 x 250	224	75	100	854 249-07

! For 200 kg loading capacity on drawers and pull-out shelves add H to the end of code.

Shelving cabinets

The shelving cabinets are pre-assembled. The cabinet has sturdy double leaf-doors, flush fitting handle with two keys. Shelving cabinet can be moved with fork lift. There are leveling screws under the cabinet for adjusting the cabinet straight. Loading capacity 150 kg/shelf, 600 kg/cabinet.

Shelving cabinets are made of epoxy powder coated steel. The frames are painted with light grey RAL 7035 and doors either with blue RAL5007 or with light grey RAL7035.



Move with a pallet truck

The cabinet can be moved with a pallet truck or a forklift when it is empty. Cabinets are equipped with leveling screws.

Shelving cabinets (includes 2 or 4 shelves)

Name	Size W x D x H mm	Max load kg	Code blue	Code grey
Shelving cabinet 100/40/200	1030 x 430 x 2010	600	SC10040200-07	SC10040200-49
Shelving cabinet 100/50/200	1030 x 530 x 2010	600	SC10050200-07	SC10050200-49
Shelving cabinet 100/60/200	1030 x 630 x 2010	600	SC10060200-07	SC10060200-49
Shelving cabinet 100/40/100	1030 x 430 x 1040	300	SC10040100-07	SC10040100-49
Shelving cabinet 100/50/100	1030 x 530 x 1040	300	SC10050100-07	SC10050100-49

For additional drawers, shelves and perforated panel see page 166.



Load capacity

150 kg/shelf



600 kg/cabinet



Drawer and perforated panel available for the cabinet.

Shelving cabinets with plexiglass doors

Name	Size W x D x H mm	Code blue
Shelving cabinet 100/40/200	1030 x 430 x 2010	SC10040200-07-TD
Shelving cabinet 100/50/200	1030 x 530 x 2010	SC10050200-07-TD
Shelving cabinet 100/60/200	1030 x 630 x 2010	SC10060200-07-TD

Includes 4 shelves. For additional shelves and perforated panel see page 166.

Shelving cabinets with plexiglass doors

Name	Size W x D x H mm	Code grey
Shelving cabinet 100/40/200	1030 x 430 x 2010	SC10040200-41-TD
Shelving cabinet 100/50/200	1030 x 530 x 2010	SC10050200-41-TD
Shelving cabinet 100/60/200	1030 x 630 x 2010	SC10060200-41-TD

Includes 4 shelves. For additional shelves and perforated panel see page 166.



Our 400, 500 and 600 mm deep shelf and stacking bins are ideal to use with shelving cabinets.

Industrial cabinets

High-quality industrial cabinets are made of epoxy powder coated steel. The cabinet frames have a lock with two keys, sturdy double leaf-doors and adjustable feet, and with a wide range of accessories it can be easily customized into versatile storage solutions, e.g. for tool storage or shelving. The industrial cabinets are pre-assembled. The frames are painted with light grey RAL 7035 and doors either with blue RAL 5007 or with light grey RAL 7035.



All cabinets are also available with flush fitting handle lock or digital code lock.

Alternate locking method can be ordered by adding a T or E in the end of the product code (e.g. C309 07 000 T).



T= for flush fitting handle



E = for digital code lock

Both locks are also available to the shelving system cabinets.

Industrial cabinet combinations

55/100-1 C 301 07 001

Qty	Name	Size W x D x H mm	Code
1	Cabinet frame 55/100	550 x 425 x 1000	C 301 07 000
2	Steel shelf 55	545 x 391 x 32	854 349-49

(Flush fitting handle not suitable)

80/100-1 C 305 07 001

Qty	Name	Size W x D x H mm	Code
1	Cabinet frame 80/100	800 x 425 x 1000	C 305 07 000
2	Steel shelf 80	730 x 396 x 32	854 345-49



Combination name

55/100-1

Width cm

Height cm

Version

Depth of cabinet: 425 mm



Practical!

100 cm high cabinet tops have a back stop and rubber mat to be used as an additional work top.



80/100-2 C 305 07 002

Qty	Name	Size W x D x H mm	Code
1	Cabinet frame 80/100	800 x 425 x 1000	C 305 07 000
2	Steel shelf 80	730 x 396 x 32	854 345-49
1	Drawer 80	730 x 362 x 90	854 346-49

**55/160-1 C 303 07 001**

Qty	Name	Size W x D x H mm	Code
1	Cabinet frame 55/160	550 x 425 x 1600	C 303 07 000
3	Steel shelf 55	545 x 391 x 32	854 349-49

(Flush fitting handle not suitable)

**80/160-1 C 307 07 001**

Qty	Name	Size W x D x H mm	Code
1	Cabinet frame 80/160	800 x 425 x 1600	C 307 07 000
3	Steel shelf 80	730 x 396 x 32	854 345-49

**Move with a pallet truck**

The cabinet can be moved with a pallet truck or a forklift when the plinth front panel has been removed. Cabinets are equipped with leveling screws.

80/160-2 C 307 07 102

Qty	Name	Size W x D x H mm	Code
1	Cabinet frame 80/160	800 x 425 x 1600	C 307 07 000
2	Steel shelf 80	730 x 396 x 32	854 345-49
4	Bin rail, M750	742 x 100	859 151-49
21	Stacking bin	105 x 165 x 75	1015-5
5	Stacking bin	149 x 250 x 130	1525-5



ESD versions also available!

All industrial cabinets can be ordered as ESD versions by replacing the colour code 07 (blue) with 49 (ESD light grey). This means that in addition to the cabinet frame, the doors will also be painted with light grey ESD paint, RAL 7035. Please remember to use only ESD bins and mats with these ESD industrial cabinets.



80/200 C 309 49 001

Qty	Name	Size W x D x H mm	Code
1	Cabinet frame 80/200	800 x 425 x 2000	C 309 49 000
4	Steel shelf 80	730 x 396 x 32	854 345-49

80/100 C 305 49 001

Qty	Name	Size W x D x H mm	Code
1	Cabinet frame 80/100	800 x 425 x 1000	C 305 49 000
2	Steel shelf 80	730 x 396 x 32	854 345-49



80/200-1 C 309 07 001

Qty	Name	Size W x D x H mm	Code
1	Cabinet frame 80/200	800 x 425 x 2000	C 309 07 000
4	Steel shelf 80	730 x 396 x 32	854 345-49

80/200-2 C 309 07 102

Qty	Name	Size W x D x H mm	Code
1	Cabinet frame 80/200	800 x 425 x 2000	C 309 07 000
2	Drawer 80	730 x 362 x 90	854 346-49
2	Steel shelf 80	730 x 396 x 32	854 345-49
5	Stacking bin	149 x 250 x 130	1525-5
1	Bin rail, M750	742 x 100	859 151-49
1	Extendable shelf 80	730 x 362 x 42	854 347-49
1	Perforated panel M750	736 x 640	835 633-07
2	Perforated panel	290 x 740	854 353-07
1	Pair of support feet	40 x 220	864 730-49



80/200-3 C 309 07 103

Qty	Name	Size W x D x H mm	Code
1	Cabinet frame 80/200	800 x 425 x 2000	C 309 07 000
2	Drawer 80	730 x 362 x 90	854 346-49
2	Steel shelf 80	730 x 396 x 32	854 345-49
3	Shelf divider	H 370/400	832 855-49
1	Perforated panel M750	736 x 640	835 633-07
1	Extendable shelf 80	730 x 362 x 42	854 347-49
1	Pair of support feet	40 x 220	864 730-49
1	Pair of steel dividers	285 x 190	861 116-49
1	Drawer for suspension folders	724 x 350 x 240	854 348-49



When the cabinet is used for storing folders, a separate pull-out shelf is a good idea. This shelf makes it easy to browse through the folders.

Industrial cabinet with plexiglass doors

Name	Size W x D x H mm	Max load kg	Code
Cabinet frame 80/200, blue doors	800 x 425 x 2000	1000	C 309 07 000-TD
Cabinet frame 80/200, grey doors	800 x 425 x 2000	1000	C 309 41 000-TD
Cabinet 80/200 with 4 shelves, blue doors	800 x 425 x 2000	1000*	C 309 07 001-TD
Cabinet 80/200 with 4 shelves, grey doors	800 x 425 x 2000	1000*	C 309 41 001-TD

* 100 kg / shelf



Computer cabinet

Computer cabinet protects equipment from dust and dirt, even in the most demanding conditions. The computer cabinet is pressurised and equipped with an air filter that keeps the dust out. A screen up to a maximum size of 26" will fit in the computer cabinet.

Name	Size mm	Code
Computer cabinet	800 x 500 x 1600	854 358-49
Computer cabinet (without the energy rail)	800 x 500 x 1600	854 364-49

Flush fitting handle not suitable.



Industrial cabinet accessories

Most of the M750 accessories fit the cabinet 80 and can be easily installed inside.

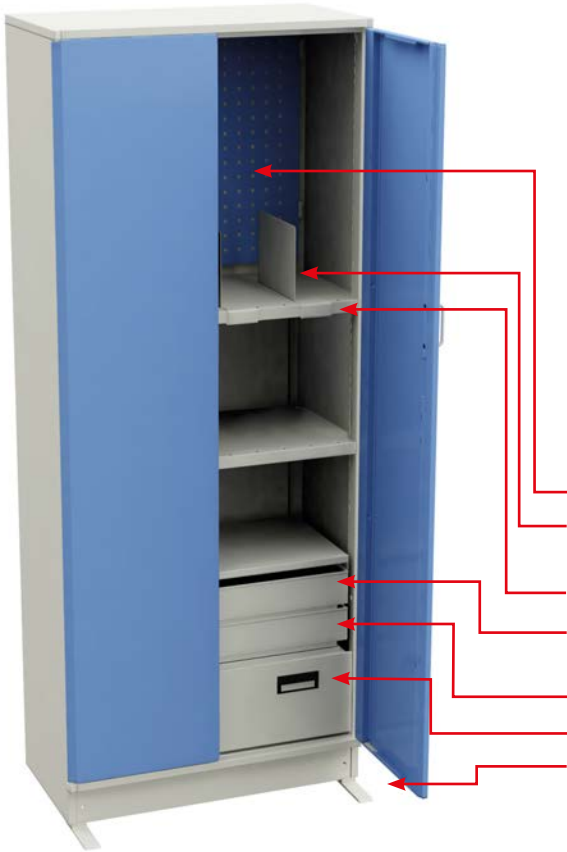

Cabinet frames

Name	Size W x D x H mm	Code
Cabinet frame 55/100	550 x 425 x 1000	C 301 07 000
Cabinet frame 80/100	800 x 425 x 1000	C 305 07 000
Cabinet frame 55/160	550 x 425 x 1600	C 303 07 000
Cabinet frame 80/160	800 x 425 x 1600	C 307 07 000
Cabinet frame 80/160, half doors	800 x 425 x 1600	C 307 07 004
Cabinet frame 80/200	800 x 425 x 2000	C 309 07 000

Cabinet frames can be ordered with a turning handle with integrated key lock by adding a T in the end of the product code (e.g. C309 07 000 T). Not suitable for 55/100 and 55/160.

Cabinet accessories

Name	Size W x D x H mm	Max load kg	Code
Perforated panel for the door or side wall	290 x 740		854 353-07
Perforated panel for the back wall M500	468 x 389		860 951-49
Perforated panel for the back wall M750	736 x 640		835 633-07/-49
Perforated panel for the back wall M750	736 x 1003		835 641-07/-49
Pair of steel dividers	1 x 285 x 190		861 116-49
Steel shelf 55	545 x 391 x 32	100	854 349-49
Steel shelf 80	730 x 396 x 32	100	854 345-49
Extendable shelf 80	730 x 362 x 42	30	854 347-49
Drawer 55	480 x 362 x 90	30	854 344-49
Drawer 80	730 x 362 x 90	30	854 346-49
Drawer for suspension folders	724 x 350 x 240	30	854 348-49
Pair of support feet	40 x 220 x 6		864 730-49
Bin rail		50	859 151-49

Cone rack M750

Name	Size W x D mm	Max load kg	Code
Cone rack M750	742 x 206 x 95	50	890 729-49

Can be mounted to uprights, Fitter's trolley, Basic trolley, industrial screen, Treston Tower and industrial cabinet.

Tool holders

Name	Cone rack M750 can hold pcs	Width mm	Code
Tool holder, HSK A40-B53	11	64	854 213-00
Tool holder, HSK A63-B83	8	82	854 212-00
Tool holder, HSK A100-B128	6	106	854 211-00
Tool holder, CAPTO C4	8	82	854 210-00
Tool holder, CAPTO C5	8	82	854 209-00
Tool holder, CAPTO C6	8	82	854 208-00
Tool holder, CAPTO C8	6	106	854 207-00
Tool holder, ISO 30	11	65	854 205-00
Tool holder, ISO 40	11	65	854 204-00
Tool holder, ISO 45	8	83	854 206-00
Tool holder, ISO 50	7	101	854 200-00



Cone rack M750

Perforated panels



Perforated panels are efficient dividers of space and, at the same time, practical storage facilities for tools and equipment. An industrial screen can be used as a sound-insulating space divider by equipping it with back panel elements with fireproof insulation.

Order and tidiness are appreciated

Order and tidiness cannot be achieved and maintained without there being a place for each tool. Perforated panels and hooks offer a practical and versatile solution for storing tools and equipment. Perforated panel products are available for direct fastening to the wall or for fastening to upright profiles or tubes.

Perforated back and wall panels

The perforated back panels are fastened either to the upright tubes (with Concept, TED, TP benches and Workshop benches) or accessory frame AKK (with WB bench). The size of the perforation is 9 x 9 mm, center to center 38 mm.

1. Perforated panels for upright tubes

Name	Module	Size W x H mm	Code
Perforated back panel	M500	468 x 389	861 501-07/-49
Perforated back panel	M750	718 x 194	861 510-07/-49
Perforated back panel	M750	718 x 389	861 511-07/-49
Perforated back panel	M750	718 x 612	861 512-07/-49
Perforated back panel, insulated	M750	718 x 612	861 701-07/-49
Perforated back panel	M750	718 x 1003	861 514-07/-49
Perforated back panel	M900	871 x 389	861 516-07/-49
Perforated back panel	M900	871 x 612	861 517-07/-49
Perforated back panel	M900	871 x 1003	861 519-07/-49
Perforated back panel	M1000	968 x 389	861 532-07/-49
Perforated back panel	M1000	968 x 612	861 538-07/-49
Perforated back panel	M1000	968 x 1003	861 535-07/-49
Perforated back panel	M1200	1168 x 389	861 533-07/-49
Perforated back panel	M1350	1318 x 389	861 521-07/-49
Perforated back panel	M1500	1474 x 389	861 526-07/-49
Perforated back panel	M1800	1774 x 389	861 531-07/-49

Fastened to the upright tubes (see page 57).

2. Back panels for upright tubes

Name	Module	Size W x H mm	Code
Back panel	M500	468 x 389	861 541-49
Back panel	M750	718 x 194	861 550-49
Back panel	M750	718 x 389	861 551-49
Back panel	M750	718 x 612	861 552-49
Back panel	M900	871 x 389	861 556-49

Fastened to the upright tubes (see page 57).

3. Perforated panels for TPH benches

Size W x H mm	Suitable for	Code
1115 x 750	TPH712	RL120
1415 x 750	TPH715/ 915	RL150
1715 x 750	TPH718/ 918	RL180
Panel hooks	TPH	RK1

Mount on TPH benches with panel hooks RK1. Can also be attached to a wall with screws (included).

4. Perforated panels for WB benches

Size W x H mm	Suitable for	Code
668 x 500	AKK70, AKK150	ARL70
968 x 500	AKK180	ARL100

Mount on accessory frame AKK (see page 74).

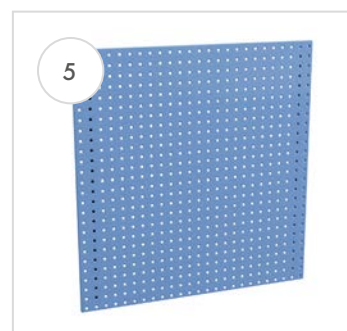
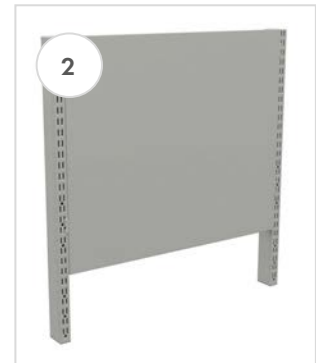
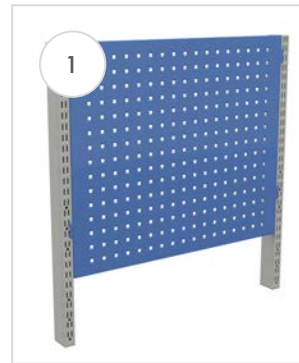

5. Perforated wall panels fastened to the wall

Name	Size W x H mm	Code
Perforated wall panel	454 x 988	837 369-07
Perforated wall panel	949 x 988	837 334-07
Perforated wall panel	949 x 1444	837 342-07
Perforated wall panel	949 x 1976	837 350-07

Fastened directly to the wall using screws.

Perforated industrial screens

These industrial screens are modular, and they can be equipped with all M750 accessories. Industrial screens can be used as space dividers. They can also provide noise insulation; the combinations available have perforated back panels on both sides and one side is insulated.

Industrial screens

Name	Size W x D x H mm	Code
Standard part, T-foot	780 x 560 x 1850	C 520 07 101
Extension part, T-foot	750 x 560 x 1850	C 520 07 102
Extension part, L-foot	750 x 310 x 1850	C 520 07 103
Extension part, I-foot	750 x 60 x 1850	C 520 07 104

Includes 6 perforated back panels, 3 pcs./side.

The standard part includes two feet.

The extension part includes one foot.

Parts

Name	Size W x D x H mm	Code
T-foot	1850	836 516-49
L-foot	1850	836 532-49
I-foot	1850	836 597-49
Spacer bar	750	835 838-49
Corner joint pair*		847 615-51
Perforated back panel M750	718 x 17 x 612	861 512-07/-49
Perforated back panel M750, insulated**	718 x 17 x 612	861 701-07/-49
Upper list	718 x 65	851 907-07

The wall module requires two spacer bars.

* For fixing two wall modules at 90° angle

** The insulation material used is polyether foam.

Most M750 accessories are suitable for the industrial screen.

Examples of industrial screen accessories

Name	Size W x D mm	Max load kg	Code
Steel shelf M750	740 x 300	50	836 028-49
Steel shelf M750	740 x 400	50	852 770-49
Bin rail M750	742 x 100	50	859 151-49
Auxiliary steel shelf for perforated panel	159 x 243 x 56		ASSA5PP

+

More accessories starting from page 57.

M750 accessories suit these industrial screens.



The colour code is included in those product codes that are formed with numbers.

It is either at the end, following the hyphen (e.g. 860 804-49), or in the middle (e.g. C 334-07 000).



Standard part, T-foot



Extension part, T-foot

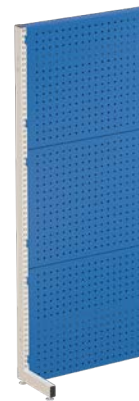

Extension part, L-foot



Extension part, I-foot



Steel shelf



Bin rail M750 with brackets and stacking bins.



Auxiliary steel shelf for perforated panel

Tool storage systems

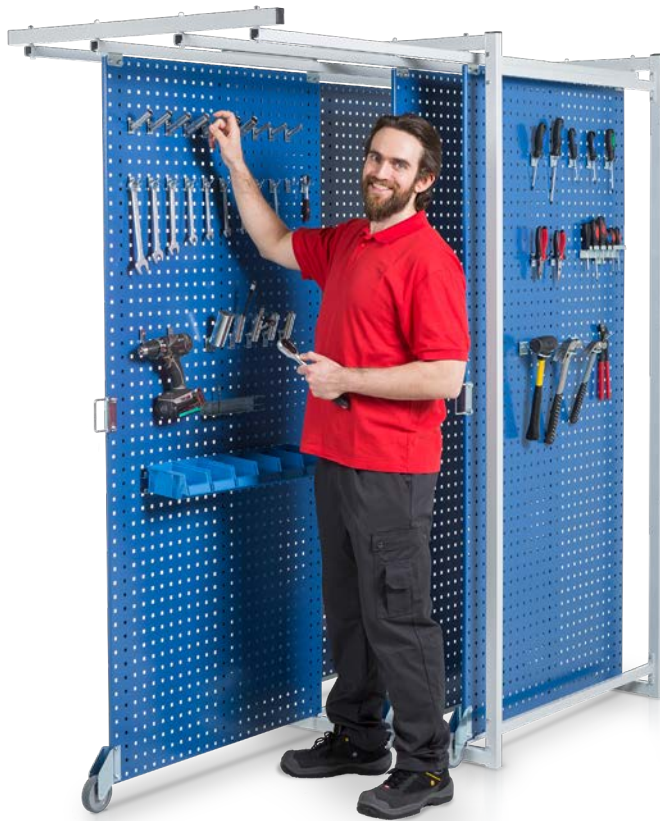

These two little giants provide efficiency and order to the storage of tools and components. Their capacity is sufficient even for extremely heavy loads, and thanks to the versatile selection of accessories, you can customise them to meet your needs.

The tool storage system is a handy storage solution comprising a sturdy frame and perforated panels. Treston Tower is a 4-sided, movable little giant for efficient storage and work.

+

Treston Industrial Multi Trolley with perforated panels on page 114.



Tool storage system

Tool storage system requires only 2 m² of floor space and provides 16 m² of storage space. There is no need to fasten it to the floor, as it stands firmly on its own. There is a castor on the lower edge of the panels which makes them easy to move.

The load capacity is 100 kg/panel. Includes 4 panels; additional panels are available (ordered separately). A maximum of 10 panels can be fastened to the tool storage system.

Tool storage system

Name	Size W x H mm	Code
Tool storage system, 4 panels	1025 x 1035 x 2125	830 518-07P/-49P
Additional panel	15 x 949 x 1976	830 682-07P/-49P



Cabinet style tool storage



Watch this animation showcasing the versatile usage options of our technical furniture: <https://vimeo.com/213996808>



Treston Tower storage and workstation unit

Being versatile and easily customisable for different environments and tasks, the Treston Tower storage and workstation unit is ideal for, for example, vehicle and machinery assembly lines, service and maintenance departments, and for any work that requires plenty of mobile storage and workspace near the product under work.

When the storage and/or load capacity of a wheeled service trolley or drawer unit is not enough and you need a unit that is easier to move than a fixed workstation and can be equipped in many ways, the Treston Tower storage and workstation unit is the correct choice.

The frame is made of powder-coated steel (grey, RAL7045). Accessories and add-on products are available in light grey (RAL7035).

Treston Tower storage and workstation unit

Name	Size W x D x H mm	Max load kg	Code
Treston Tower frame	860 x 880 x 1960	1000	890 700-45
Treston Tower frame with castors	860 x 880 x 2105	600	890 701-45





Examples of accessories and add-on products

Name	Size W x D x H mm	Max load kg	Code
1 Flow-through shelf + brackets M750*	718 x 830	150	890 710-49
2 Spacer bar, M750**			851 483-49
3 Perforated back panel M750, max 3 pcs/side	718 x 612		861 512-49
4 Hook set 3 (69 pcs)			855 003-51
5 Steel shelf M750	740 x 400	50	852 770-49
6 Bin rail M750	742 x 100	50	859 151-49
7 LCD monitor holder for perforated panel		10	890 715-49
8 Treston NaturLite Led Wing 500	430 x 120 x 50 (+ bracket 95/120 mm)		TNL500W

* A flow-through shelf can fit two 400-mm deep shelf bins successively.

** Recommended to be used with flow-through shelving.



Wide range of accessories and add-on products

Because the frame is equipped with the M750 upright frame module, almost all modular size M750 accessories are compatible with the Treston Tower storage and workstation unit. Also remember the tool hooks (R hooks) and stacking and shelf bins.



Watch this animation showcasing the versatile usage options of our technical furniture: <https://vimeo.com/360212786>



Panel hooks



Our selection includes more than 50 different kinds of hooks and brackets for the efficient storage and organisation of tools. All the panel hooks and tool holders are easy to attach to the perforated panels and wall panels. The perforated panels are an efficient way to integrate the tool holders and panel hooks to Treston workbenches, trolleys and cabinets. You can also create a tool storage on the wall by using the perforated wall panels.

Hooks also for heavy loads

The hooks can withstand loads of up to 10 kg.



Panel hooks

Hook R1

Name	L	Ø	Max load kg	Code
Hook R1	30	3	10	853 207-51
Hook R1	50	4	10	853 208-51
Hook R1	50	6	10	853 241-51
Hook R1	80	6	10	853 209-51
Hook R1	100	4	8	853 210-51
Hook R1	100	6	10	853 211-51
Hook R1	150	4	4	853 212-51
Hook R1	150	6	10	853 213-51
Hook R1	200	4	2	853 214-51
Hook R1	200	6	6	853 215-51
Hook R1	300	6	3	853 216-51
Hook R1	300	8	8	853 217-51

L = hook length mm

All order numbers include 5 pcs.

Hook R2

Name	L	Ø	A	Max load kg	Code
Hook R2	33	3	17	10	853 218-51
Hook R2	43	4	25	10	853 219-51
Hook R2	43	4	40	10	853 220-51
Hook R2	100	6	25	10	853 221-51
Hook R2	150	4	16,5	6	853 222-51
Hook R2	150	6	25	10	853 223-51
Hook R2	200	6	25	10	853 224-51

L = hook length mm

A = free gap mm

All order numbers include 5 pcs.

Hook R3

Name	L	Ø	Max load kg	Code
Hook R3	10	6	10	853 225-51
Hook R3	50	6	10	853 226-51

L = hook length mm

All order numbers include 5 pcs.

Hook R10

Name	L	A	Max load kg	Code
Hook R10	28	9	10	853 227-51
Hook R10	33	17	10	853 228-51

L = hook length mm

A = free gap mm

All order numbers include 5 pcs.

Hook R13

Name	L	Ø	Max load kg	Code
Hook R13	157	3	1	853 229-51

L = hook length mm

The order number includes 5 pcs.

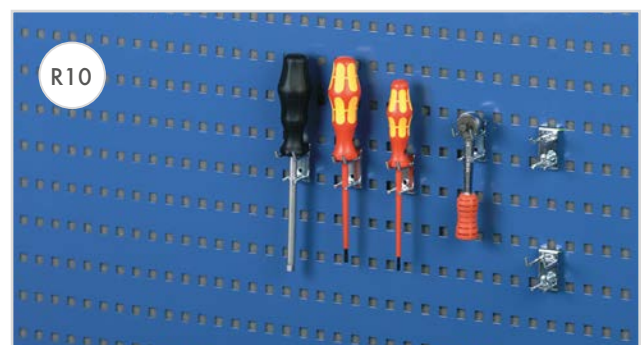

Hook R16

Name	L	Max load kg	Code
Hook R16	20	10	831 514-51
Hook R16	46	10	831 506-51

L = hook length mm

All order numbers include 1 pc.

Hook R19

Name	Ø	Code
Hook R19	13	853 231-51
Hook R19	19	853 232-51
Hook R19	22	853 233-51

All order numbers include 5 pc.

Hook R24

Name	L	Ø	Code
Hook R24	65	17	831 700-51
Hook R24	80	26	831 719-51
Hook R24	100	42	852 167-51

L = hook length mm

All order numbers include 1 pc.

Hook R26

Name	L	Ø	Code
Hook R26	160	10	838 896-51

L = hook length mm

The order number includes 1 pc.

Hook R29

Name	L	Max load kg	Code
Hook R29	40	5	853 234-51
Hook R29	60	5	853 235-51
Hook R29	80	10	853 236-51

L = hook length mm

All order numbers include 5 pcs.

Hook R30

Name	L	Ø	Max load kg	Code
Hook R30	35	4	10	853 237-51
Hook R30	85	6	10	853 238-51

L = hook length mm

All order numbers include 5 pcs.

Hook R33

Name	H	Ø	Code
Hook R33	30	90	832 162-51

H = hook height mm

The order number includes 1 pc.

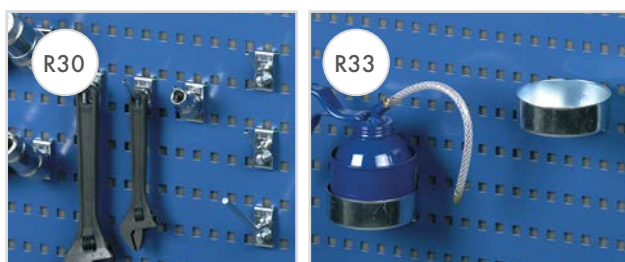
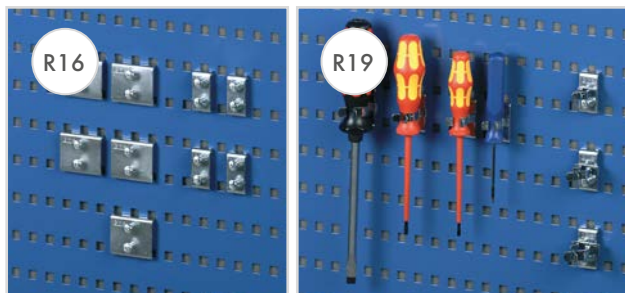

Hook R35

Name	L	A	Max load kg	Code
Hook R35	17	35	5	853 239-51
Hook R35	17	55	5	853 240-51

L = hook length mm

A = free gap mm

All order numbers include 5 pcs.

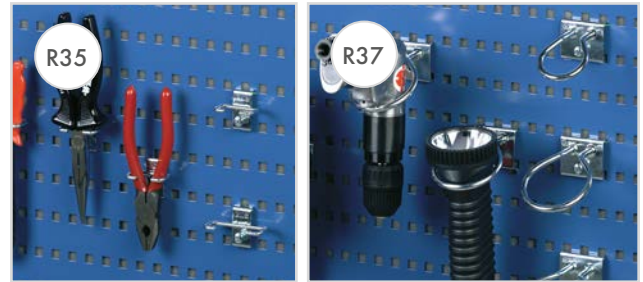
**Hook R37**

Name	Ø	Max load kg	Code
Hook R37	40	10	831 433-51
Hook R37	60	10	831 441-51
Hook R37	80	10	831 603-51

All order numbers include 1 pc.

**Hook R41**

Name	L	Code
Hook R41	556	838 357-51

L = hook length mm

The order number includes 1 pc.

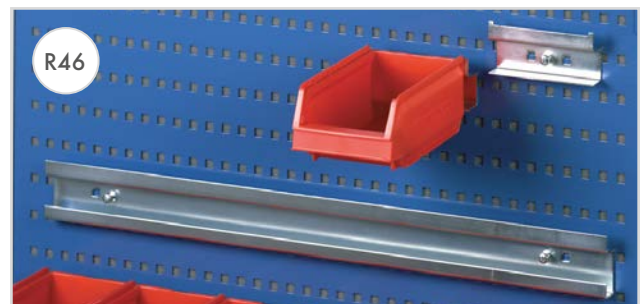
**Hook R46**

Name	L		Code
Hook R46	112	for stacking bins 1015 and 30-1L	831 794-51
Hook R46	634	bin rail for six stacking bins 1015 and 30-1L	839 086-51

L = hook length mm

All order numbers include 1 pc.

**Hook R47**

Name	W x D	Max load kg	Code
Hook R47	350 x 120	4	831 654-49

The order number includes 1 pc.

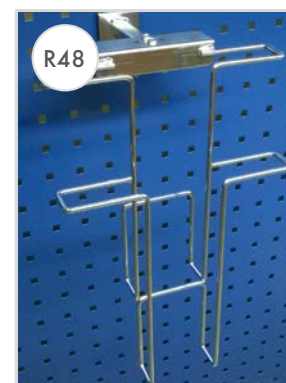
**Hook R48**

Name	W x D x H	Code
Hook R48	235 x 200 x 370	838 380-51

The order number includes 1 pc.

Hook R49

Name	W x D x H	Code
Hook R49	300 x 70 x 40	838 381-51

The order number includes 1 pc.



Hook R50

Name	W x D x H	Code
Drill bit holder	238 x 43x 60/80	838 382-51
The order number includes 1 pc.		



Other supplies

Name	Size W x D x H mm	Max load kg	Code
Paper roll holder	max roll width 300 mm		854 043-49
Box holder for four pick up boxes	456 x 165 x 48	5	854 042-49
Pick up box	149 x 85 x 48		851 843-00
Utility box	410 x 155 x 90	4	854 041-49
Folder compartment	466 x 90 x 240	4	854 040-49
LCD monitor holder for perforated panel	120 x 38 x 150	10	890 715-49
Auxiliary steel shelf for perforated panel	159 x 243 x 56		ASSA5PP
Bracket for fixing small plastic storage cabinet to perforated panel	274 x 12 x 46		890 535-51



Paper roll holder



Box holder



Utility box



Folder compartment



LCD monitor holder for perforated panel



Auxiliary steel shelf for perforated panel



Bracket for fixing small plastic storage cabinet to perforated panel

Hook sets

Ready-made hook sets help you to get started. Choose the most suitable hook set for your needs from the following possibilities:



Hook set 1: Basic light hook set



Hook set 2: Basic hook set for hand tools



Hook set 3: Hook set for perforated tool cabinet



Hook set 4: All inclusive set for hand tools



Hook set 5: Hook set for heavy tools in perforated tool cabinet

Hooks included in the sets (Code)	Hooks sets							
	L mm	Ø mm	A mm	Set 1 855 001-51	Set 2 855 002-51	Set 3 855 003-51	Set 4 855 004-51	Set 5 855 005-51
R1 (853 207-51)	30	3			5	15	10	10
R1 (853 208-51)	50	4		5	5		10	10
R1 (853 211-51)	100	6						10
R2 (853 218-51)	33	3	17	5	5	5	5	5
R2 (853 219-51)	43	4	25				5	5
R2 (853 220-51)	43	4	40					5
R10 (853 227-51)	28		9					5
R10 (853 228-51)	33		17					5
R19 (853 231-51)		13					5	5
R19 (853 232-51)		19		5	5	5	5	5
R19 (853 233-51)		22			5			5
R24 (831 719-51)	80	26			1	5	7	3
R24 (852 167-51)	100	42				1	2	3
R29 (853 235-51)	60				5			5
R30 (853 237-51)	35	4		5	5	35	40	10
R33 (832 162-51)	30	90			1	1	2	1
R35 (853 239-51)	17		35		5		5	5
R35 (853 240-51)	17		55					5
R37 (831 441-51)		60			1		3	3
R43 (838 373-51)	42		238			1		
R49 (838 381-51)	300				2	1	1	2
Pieces				20	45	69	100	107

L = hook length mm
A = free gap mm

Bins and cabinets



Storage bins and drawer storage units are the essence of small-parts storage and parts picking. The wide selection of Treston products includes solutions for the sorting, storage, and use of items and parts of various shapes and sizes. Also suitable for EPAs. Durable and functional storage – now and in the future.

Small-parts storage cabinets

These cabinets can be wall hung or mounted on bench top turntables, or stood on the work top. Two frames of different heights are available, 290 and 550 mm. A storage cabinet consists of a frame, shelves, small drawers and labels. The back of the cabinets feature ready-made holes for wall mounting. Cross and length dividers are available as an accessory.

+

Small drawers on page 206.



Series 290 (Size W x D x H mm: 310 x 180 x 290)

Code	290-3	291-3	292-3	294-3	296-3	297-3	290C-3
Includes drawers of type (quantity/drawer)	L-00 (30 pcs)	L-01 (24 pcs)	L-02 (12 pcs)	L-04 (12 pcs)	L-06 (4 pcs)	L-07 (6 pcs)	L-01 (12 pcs) L-04 (3 pcs) L-06 (1 pcs)
Cross dividers, ordered separately (quantity/drawer)	V-00 (5 pcs)	V-01 (5 pcs)	V-02 (5 pcs)	V-04 (5 pcs)	V-06 (5 pcs)	V-07 (5 pcs)	V-01 (5 pcs) V-04 (5 pcs) V-06 (5 pcs)
Length dividers, ordered separately (quantity/drawer)	-	V-012 (1 pcs)	V-012 (3 pcs)	V-0456 (1 pcs)	V-0456 (5 pcs)	V-078 (3 pcs)	V-012 (1 pcs) V-0456 (1 pcs) V-0456 (5 pcs)

Grey frame (RAL7016), crystal clear drawers and self-adhesive labels. Strong polypropylene (PP) frame, shelves made of galvanised steel and drawers made of clear polystyrene (PS).



Series 290 ESD (Size W x D x H mm: 310 x 180 x 290)

Code ESD	291-4ESD	294-4ESD
Includes drawers of type (quantity/drawer)	L-61-4ESD (24 pcs)	L-64-4ESD (12 pcs)
Cross dividers, ordered separately (quantity/drawer)	V-1-4ESD (5 pcs)	V-4-4ESD (5 pcs)

The frame is made of semiconductive polypropylene (PP), the drawers of semiconductive polystyrene (PS), and the shelves of galvanised steel.





Series 550 (Size W x D x H mm: 310 x 180 x 550)

Code	550-3	551-3	552-3	554-3	556-3	557-3	550C-3
Includes drawers of type (quantity/drawer)	L-00 (60 pcs)	L-01 (48 pcs)	L-02 (24 pcs)	L-04 (24 pcs)	L-06 (8 pcs)	L-07 (12 pcs)	L-01 (24 pcs) L-04 (6 pcs) L-06 (2 pcs)
Cross dividers, ordered separately (quantity/drawer)	V-00 (5 pcs)	V-01 (5 pcs)	V-02 (5 pcs)	V-04 (5 pcs)	V-06 (5 pcs)	V-07 (5 pcs)	V-01 (5 pcs) V-04 (5 pcs) V-06 (5 pcs)
Length dividers, ordered separately (quantity/drawer)	-	V-012 (1 pcs)	V-012 (3 pcs)	V-0456 (1 pcs)	V-0456 (5 pcs)	V-078 (3 pcs)	V-012 (1 pcs) V-0456 (1 pcs) V-0456 (5 pcs)

Grey frame (RAL7016), crystal clear drawers and self-adhesive labels. Strong polypropylene (PP) frame, shelves made of galvanised steel and drawers made of clear polystyrene (PS).



Series 550 ESD (Size W x D x H mm: 310 x 180 x 550)

Code	551-4ESD	554-4ESD
Includes drawers of type (quantity/drawer)	L-61-4ESD (48 pcs)	L-64-4ESD (24 pcs)
Cross dividers, ordered separately (quantity/drawer)	V-1-4ESD (5 pcs)	V-4-4ESD (5 pcs)

The frame is made of semiconductive polypropylene (PP), the drawers of semiconductive polystyrene (PS), and the shelves of galvanised steel.



+ **Cabinet trolley on page 129.**
This assembly holds 8 cabinets, which must be ordered separately.



Spacemisers for small-parts storage cabinets

Perfect for storage and identification of thousands of small components in retail, manufacturing, workshops and warehousing. A storage spacemiser holds 12 small-parts storage cabinets from series 550, which must be ordered separately (cabinets on page 192). Owing to its robust base and divider shelf system, the spacemiser retains its cabinets firmly in place and has a load capacity of 400 kg.

Mounted on a ball-bearing base, the unit can be effortlessly rotated for ease of use. This assembly offers storage for up to 4320 different items on a floor area of only 0.25 sqm. The unit is easy to assemble.

Spacemiser

Size W x D x H mm	Max load kg	Code	Code ESD
500 x 500 x 1730*	400	12-550	12-550 ESD

*The overall dimensions of a completely assembled unit.

Bench top spacemiser PTP-5

The product holds 2 small-parts storage cabinets from series 550 or 290 which must be ordered separately (cabinets on pages 183-184). The unit includes a ball bearing base.

Bench top spacemiser

Size W x D x H mm*	Max load kg	Code	Code ESD
360 x 310 x 300 mm (series 290)*	50	PTP-5	PTP-5 ESD
360 x 310 x 560 mm (series 550) *			

*The overall dimensions of a completely assembled unit.



Spacemiser



ESD bench top spacemiser

Storage bin cabinets

These cabinets can be wall hung or mounted on turntables, or stood on a work top. This product is available in two depths, 300 and 400 mm.

This product includes a frame, bins and labels with protective shields. Backstops hold the bins when fully extended. The sturdy steel frame has been given a durable powder-coat finish in grey (RAL 7035), and the back of the cabinet includes holes for wall mounting. The bins are of clear polystyrene (PS), coloured polypropylene (PP) or recycled polypropylene (PP). The bins are detailed on page 197.



Storage bin cabinets

Colour	Code	Code	Code	Code
Crystal clear	0830-1	1630-1	0840-1	1640-1
Grey	0830-3	1630-3	0840-3	1640-3
Red	0830-5	1630-5	0840-5	1640-5
Blue	0830-6	1630-6	0840-6	1640-6
ESD	0830 ESD	1630 ESD	0840 ESD	1640 ESD
Includes drawers (type/quantity)	3020 (8 pcs)	3010 (16 pcs)	4020 (8 pcs)	4010 (16 pcs)
Frame width (mm)	400	400	400	400
depth mm	300	300	400	400
height (mm)	395	395	395	395
Cross dividers, ordered separately (quantity/drawer)	D-20 / D-20-4ESD (max. 4 pcs)	D-10 / D-10-4ESD (max. 4 pcs)	D-20 / D-20-4ESD (max. 6 pcs)	D-10 / D-10-4ESD (max. 6 pcs)



Treston ReBOX storage bin cabinets

	Code	Code	Code	Code
Recycled plastic	6083-30R	6163-30R	6084-30R	6164-30R
Includes drawers (type/quantity)	6320-30R (8 pcs)	6310-30R (16 pcs)	6420-30R (8 pcs)	6410-30R (16 pcs)
Frame width (mm)	400	400	400	400
depth mm	300	300	400	400
height (mm)	395	395	395	395
Cross dividers, ordered separately (quantity/drawer)	620 (max. 4 pcs)	610 (max. 4 pcs)	620 (max. 6 pcs)	610 (max. 6 pcs)

The Treston ReBOX bins are detailed on page 201.

Spacemisers for storage bin cabinets

1

1 x spacemiser 16-300
8 x storage bin cabinets 0830
8 x storage bin cabinets 1630

2

1 x spacemiser 16-400
8 x storage bin cabinets 1640
8 x storage bin cabinets 0840



A free-standing spacemiser storage system for stores, production facilities, workshops and warehouses. This assembly holds 16 storage bin cabinets, which must be ordered separately (cabinets on page 192). The sturdy, ball-bearing base has a load capacity of 800 kg. These assemblies offer storage for up to 1792 different items on a floor area of only 0.64 sqm. Easy to assemble – no tools required. The unit includes a ball-bearing base and shelves in four layers. The assembly is made of grey powder-coated steel (RAL 7035).

Spacemiser

Size W x D x H mm	Max load kg	Storage bin depth mm	Code	Code ESD
700 x 700 x 1680*	800	300	16-300	16-300 ESD
800 x 800 x 1680*	800	400	16-400	16-400 ESD

*The overall dimensions of a completely assembled unit.



Retaining bars

Storage bin cabinets are also suitable for use in maintenance vehicles. Retaining bars, to be ordered separately as an accessory, keep the bins in place in a moving vehicle. Retaining bars are suitable for all models.

Retaining bars

Name	Code
Retaining bar set, 4 pcs	A 400



High density storage cabinets

High density storage cabinets are suitable for the organisation and sorting of large item quantities at production facilities, warehouses, stores and workshops. One cabinet can offer storage for 336 separate items on a floor area of only 0.25 m². If necessary, the cabinets can be equipped with castors or retaining bars.

This product includes a frame, bins and labels with protective shields. Backstops hold the bins when fully extended. Adjustable feet are provided for fine levelling of the cabinet on uneven surfaces. The load capacity of a cabinet is 240 kg, and that of a single shelf is 30 kg. The frame is made of grey powder-coated steel (RAL 7035). Profiled ends and a welded steel construction contribute to the general robustness of the frame. Details on the shelf bins can be found on page 197.



High density storage cabinets

Colour	Code	Code
Grey	2440-3	4840-3
Red	2440-5	4840-5
Blue	2440-6	4840-6
ESD	2440 ESD	4840 ESD
Includes drawers (type/quantity)	4020 (24 pcs)	4010 (48 pcs)
Frame depth	410	410
width	605	605
height	870	870
Cross dividers, ordered separately (quantity/drawer)	D-20 / D-20-4ESD (6 pcs)	D-10 / D-10-4ESD (6 pcs)

Castor set

Name	Size mm	Max load kg	Code	Code ESD
Castor set, 4 pcs	Ø 100	150	PS-LH	PS-LH ESD

Retaining bars

Name	Code
Retaining bar set, 8 pcs	A-605

Note! High density storage bin cabinets have no ready-made mounting holes on the back.



High density storage cabinet 2440-6 with castor set and retaining bars.

Shelf bins



Shelf bins are also ideal with shelving cabinets, see page 170.



A series of durable, quality bins. The bin types to choose from are classic plastic (Treston Classic), sustainable wood-based bioplastic (Treston BiOX) and 100% recycled plastic (Treston ReBOX). Shelf bins are designed to fit all standard metric shelves, cabinets, paternosters and industrial workstations.

Treston Classic shelf bins

The shelf bin product family includes 11 different bin sizes to choose from. Bins of the same width stack securely, even if they are of different lengths. The depth dimensions are 300, 400, 500 and 600 mm, three different widths. Straight sides ensure an efficient use of space, and the bins are available in several bright colours to facilitate product identification. You can see the contents clearly through the transparent bins. Each bin comes with a label and protective cover.



A label with a protective shield is easy to clean and change when necessary. The shield and label is included.



Corrugated base stops items from sliding on the surface and makes picking up small items easy.



Shelf bins are designed to fit all metric shelving systems.



Individual bins can be sub-divided internally using dividers. Dividers are ordered separately.



Space is reserved for labels on the rear surface of drawers and on dividers. Labels are ordered separately.



Crystal clear

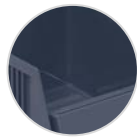

Grey,
RAL 7016



Red,
RAL 3020



Blue,
RAL 5015



Black, ESD

Treston Classic shelf bins

Accessories

	Material	External dimensions W x D x H mm	Internal dimensions W x D x H mm	Capacity, litres	Quantity/ package	Colour	Code	Cross divider	Max. amount/ bin	Label + cover
	PS	92 x 300 x 82	75 x 257 x 70	1.3	30	Crystal clear	3010-1	D-10	4 pcs.	S-10M
	PP					Grey	3010-3			
	PP					Red	3010-5			
	PP					Blue	3010-6			
	PP					ESD	3010-4ESD			
	PS	92 x 400 x 82	75 x 357 x 70	1.9	30	Crystal clear	4010-1	D-10	6 pcs.	S-10M
	PP					Grey	4010-3			
	PP					Red	4010-5			
	PP					Blue	4010-6			
	PP					ESD	4010-4ESD			
	PS	92 x 500 x 82	75 x 457 x 70	2.4	30	Crystal clear	5010-1	D-10	8 pcs.	S-10M
	PP					Grey	5010-3			
	PP					Red	5010-5			
	PP					Blue	5010-6			
	PP					ESD	5010-4ESD			
	PS	132 x 300 x 100	110 x 257 x 90	2.5	30	Crystal clear	3015-1	D-15	4 pcs.	S-15M
	PP					Grey	3015-3			
	PP					Red	3015-5			
	PP					Blue	3015-6			
	PP					ESD	-			
	PS	132 x 400 x 100	110 x 357 x 90	3.2	20	Crystal clear	4015-1	D-15	6 pcs.	S-15M
	PP					Grey	4015-3			
	PP					Red	4015-5			
	PP					Blue	4015-6			
	PP					ESD	4015-4ESD			
	PP	132 x 500 x 100	110 x 457 x 90	4.5	20	Grey	5015-3	D-15	8 pcs.	S-15M
	PP					Red	5015-5			
	PP					Blue	5015-6			
	PP					ESD	5015-4ESD			
	PP					ESD	5015-4ESD			
	PP	132 x 600 x 100	110 x 557 x 90	5.5	15	Grey	6015-3	D-15	10 pcs.	S-15M
	PP					Red	6015-5			
	PP					Blue	6015-6			
	PP					ESD	6015-4ESD			
	PP					ESD	6015-4ESD			
	PS	186 x 300 x 82	167 x 257 x 70	3.0	15	Crystal clear	3020-1	D-20	4 pcs.	S-20M
	PP					Grey	3020-3			
	PP					Red	3020-5			
	PP					Blue	3020-6			
	PP					ESD	3020-4ESD			
	PS	186 x 400 x 82	167 x 357 x 70	4.2	15	Crystal clear	4020-1	D-20	6 pcs.	S-20M
	PP					Grey	4020-3			
	PP					Red	4020-5			
	PP					Blue	4020-6			
	PP					ESD	4020-4ESD			
	PS	186 x 500 x 82	167 x 457 x 70	5.3	15	Crystal clear	5020-1	D-20	8 pcs.	S-20M
	PP					Grey	5020-3			
	PP					Red	5020-5			
	PP					Blue	5020-6			
	PP					ESD	5020-4ESD			
	PS	186 x 600 x 82	167 x 557 x 70	6.5	15	Crystal clear	6020-1	D-20	10 pcs.	S-20M
	PP					Grey	6020-3			
	PP					Red	6020-5			
	PP					Blue	6020-6			
	PP					ESD	6020-4ESD			

PS = Crystal clear polystyrene: temperature tolerance -40 ...+55°C.

PP = Coloured polypropylene: temperature tolerance -20 ... +75°C, withstands the effects of most oils, acids and solvents.

Treston BiOX shelf bins



Treston BiOX is the first wood-based bioplastic storage solution for industrial use. The carbon-neutral material of Treston BiOX bins is over 90% wood-based renewable material, residue from pulp production process, and cellulose fibres from sustainably managed forests. The quality as well as the look and feel of the bins, remains the same as with traditional plastic bins.



Looks like plastic, acts like plastic, but it is made of wood-based material.



Corrugated base stops items from sliding on the surface and makes picking up small items easy.



A label with a protective shield is easy to clean and change when necessary. The shield and label is included.



Withstands the effects of oils, most acids and solvents.



Individual bins can be sub-divided internally using dividers. Dividers are ordered separately.









Space is reserved for labels on the rear surface of drawers and on dividers. Labels are ordered separately.



All Treston bins and storage solutions gradually becoming available in bioplastic alternatives.

Treston BiOX shelf bins

Accessories

	External dimensions W x D x H mm	Internal dimensions W x D x H mm	Capacity, litres	Quantity/ package	Code	Cross divider	Max. amount/bin	Label + cover
	92 x 300 x 82	75 x 257 x 70	1,3	30	3010-7 BIOX	D-10 BIOX	4 pcs	S-10M BIOX
	92 x 400 x 82	75 x 357 x 70	1,9	30	4010-7 BIOX	D-10 BIOX	6 pcs	S-10M BIOX
	92 x 500 x 82	75 x 457 x 70	2,4	30	5010-7 BIOX	D-10 BIOX	8 pcs	S-10M BIOX
	186 x 300 x 82	167 x 257 x 70	3,0	15	3020-7 BIOX	D-20 BIOX	4 pcs	S-20M BIOX
	186 x 400 x 82	167 x 357 x 70	4,2	15	4020-7 BIOX	D-20 BIOX	6 pcs	S-20M BIOX
	186 x 500 x 82	167 x 457 x 70	5,3	15	5020-7 BIOX	D-20 BIOX	8 pcs	S-20M BIOX

Bin material: Coloured bioplastic with fiber reinforcement. Temperature tolerance -20 ... +75°C, withstands the effects of oils, most acids and solvents. Forest green colour. Due to the wood-based bioplastic material the surface of the bin may show fibers which is completely normal.

Divider material: Transparent wood-based plastic (Woody). Temperature tolerance -20...+50°C, good resistance against oils, moderate or limited resistance against polar solvents and highly acidic or alkaline media. Due to the wood-based bioplastic material the dividers may be slightly blurred.



Treston ReBOX shelf bins

Made from 100% recycled plastic, an environmentally friendly and economical range of bins that offer versatile storage. The product family includes 9 different bin sizes to choose from. The depth alternatives are 300, 400 and 500 mm, 3 different widths. Large, white labels come as standard.



Treston ReBOX was formerly named Kennoset.



Treston ReBOX shelf bins

Accessories

	Material	External dimensions W x D x H mm	Internal dimensions W x D x H mm	Capacity, litres	Quantity/ package	Code	Cross divider	Max. amount/ bin	Label
	PP	94 x 300 x 80	77 x 260 x 75	1,5	40	6310-30R	610	4 pcs	1778
	PP	94 x 400 x 80	77 x 360 x 75	2,1	40	6410-30R	610	6 pcs	1778
	PP	94 x 500 x 80	77 x 460 x 75	2,7	40	6510-30R	610	8 pcs	1778
	PP	186 x 300 x 80	173 x 260 x 75	3,4	20	6320-30R	620	4 pcs	1778
	PP	186 x 400 x 80	173 x 360 x 75	4,7	20	6420-30R	620	6 pcs	1778
	PP	186 x 500 x 80	173 x 460 x 75	6,0	20	6520-30R	620	8 pcs	1778

PP = Recycled polypropylene: temperature tolerance -20 ... +75°C, withstands the effects of most oils, acids and solvents. Grey, contains small traces of ink residues and the colour tint may vary.

Treston ReBOX shelf bins, stackable

Accessories

	Material	External dimensions W x D x H mm	Internal dimensions W x D x H mm	Capacity, litres	Quantity/ package	Code	Cross divider	Max. amount/ bin	Label
	PP	160 x 300 x 85	145 x 240 x 81	2,8	20	6316-30R	616	2 pcs	3190
	PP	160 x 400 x 85	145 x 340 x 81	4,0	20	6416-30R	616	3 pcs	3190
	PP	160 x 500 x 85	145 x 440 x 81	5,2	20	6516-30R	616	4 pcs	3190

PP = Recycled polypropylene: temperature tolerance -20 ... +75°C, withstands the effects of most oils, acids and solvents. Grey, contains small traces of ink residues and the colour tint may vary.



Stacking bins



Our stacking bins have been designed for daily use in stores, production facilities and warehouses. The bin types to choose from are classic plastic (Treston Classic) and 100% recycled plastic (Treston ReBOX). These bins have been designed to fit all standard metric shelves, paternosters and industrial workstations. Bins of the same width stack securely, even if they are of different lengths. Straight sides ensure an efficient use of space.

Treston Classic stacking bins

Our product range includes 8 bins of different sizes. The design, with a half-open front, allows excellent visibility and easy access to the bin's contents, making it easy to pick from. The colour options allow a storage system to be designed to meet the customer's requirements. The crystal clear bins are transparent, allowing easy visual identification. Bright colours make finding the right item easy.



The design, with a half-open front, allows excellent visibility and easy access to the bin's contents, making it easy to pick from.



A corrugated base stops items from sliding around on the surface and makes picking them up easier.



Bin rail 700 for stacking and picking bins. Includes screws for wall mounting. The load capacity is 50 kg. Length 700 mm. Made of grey epoxy enamelled steel profile. Stacking bins 1015 - 1930 are all suitable. Ordered separately.



A label with a self-adhesive protective shield is affixed to the front plate of the bin. Such labels are easy to change when necessary. Labels must be ordered separately.



Individual bins can be sub-divided internally using dividers. Steel dividers are powder-coated in a grey finish (RAL 7035). Dividers are ordered separately.



Self-adhesive barcodes can be affixed to the front plate and dividers of a bin.



Crystal clear

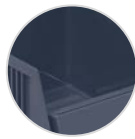

Grey,
RAL 7016



Red,
RAL 3020



Blue,
RAL 5015



Black, ESD

Treston Classic stacking bins

Accessories

	Material	External dimensions W x D x H mm	Internal dimensions W x D x H mm	Capacity, litres	Quantity/ package	Colour	Code.	Cross divider	Max. amount/ bin	Label + cover
	PS	105 x 165 x 75	90 x 105 x 65	0.6	60	Crystal clear	1015-1	-	-	E-10
	PP					Grey	1015-3			
	PP					Red	1015-5			
	PP					Blue	1015-6			
	PP					ESD	1015-4ESD			
	PS	149 x 192 x 105	125 x 130 x 90	1.5	45	Crystal clear	1520-1	-	-	E-15
	PP					Grey	1520-3			
	PP					Red	1520-5			
	PP					Blue	1520-6			
	PP					ESD	1520-4ESD			
	PS	149 x 250 x 130	125 x 185 x 115	2.7	30	Crystal clear	1525-1	V-14	1 pc.	E-15
	PP					Grey	1525-3			
	PP					Red	1525-5			
	PP					Blue	1525-6			
	PP					ESD	1525-4ESD			
	PS	186 x 300 x 156	155 x 230 x 140	5.0	24	Crystal clear	1930-1	V-19	1 pcs	E-20
	PP					Grey	1930-3			
	PP					Red	1930-5			
	PP					Blue	1930-6			
	PP					ESD	1930-4ESD			
	PS	186 x 400 x 156	155 x 330 x 140	7.2	24	Crystal clear	1940-1	V-19	3 pcs	E-20
	PP					Grey	1940-3			
	PP					Red	1940-5			
	PP					Blue	1940-6			
	PP					ESD	1940-4ESD			
	PS	186 x 500 x 182	145 x 400 x 165	9.6	12	Crystal clear	1950-1	V-195	3 pcs.	E-20
	PP					Grey	1950-3			
	PP					Red	1950-5			
	PP					Blue	1950-6			
	PP					ESD	1950-4ESD*			
	PP	310 x 400 x 156	270 x 315 x 140	11.9	12	Grey	3040-3	V-30	3 pcs.	E-20
	PP					Red	3040-5			
	PP					Blue	3040-6			
	PP					ESD	3040-4ESD*			
	PP					ESD	3040-4ESD*			
	PP	310 x 500 x 182	270 x 400 x 165	17.8	8	Grey	3050-3	V-30	3 pcs.	E-20
	PP					Red	3050-5			
	PP					Blue	3050-6			
	PP					ESD	3050-4ESD*			
	PP					ESD	3050-4ESD*			

PS = Crystal clear polystyrene: temperature tolerance -40 ... +55°C.

*) Made to order. Request a quotation.

PP = Coloured polypropylene: temperature tolerance -20 ... +75°C, withstands the effects of most oils, acids and solvents.



Stacking bin trolley on page 128.

Up to 112 stacking bins can be attached to one trolley, must be ordered separately





Treston ReBOX stacking bins

Made from 100% recycled plastic, an environmentally friendly and economical range of bins that offer versatile storage. The product family includes 7 different bin sizes to choose from. An open front makes picking easier, length dividers available for some bin models.



Treston ReBOX was formerly named Kennoset.



Treston ReBOX stacking bins

	Material	External dimensions W x D x H mm	Internal dimensions W x D x H mm	Capacity, litres	Quantity/ package	Code	Divider	Label
	PP	103 x 160 x 73*	87 x 120 x 65	0,7	20	6547-30R	-	1790
	PP	146 x 250 x 12*	123 x 180 x 120	2,7	20	6546-30R	-	1790
	PP	205 x 340 x 153*	180 x 285 x 140	7,2	12	6545-30R	-	1790
	PP	310 x 500 x 180	270 x 410 x 170	18,8	8	6544-30R	-	1790

* Bin can be hung on wall-mounted bin rails.

PP = Recycled polypropylene: temperature tolerance -20 ... +75°C, withstands the effects of most oils, acids and solvents. Grey, contains small traces of ink residues and the colour tint may vary.

Treston ReBOX stacking bins, longitudinally dividable

	Material	External dimensions W x D x H mm	Internal dimensions W x D x H mm	Capacity, litres	Quantity/ package	Code	Length divider	Max. amount/ bin	Label
	PP	230 x 300 x 120	205 x 225 x 110	5,1	12	6323-30R	630-30R	1 pc	3189
	PP	230 x 400 x 150	205 x 325 x 140	9,3	12	6423-30R	640-30R	1 pc	3189
	PP	230 x 500 x 150	205 x 425 x 140	12,2	12	6523-30R	650-30R	1 pc	3189

PP = Recycled polypropylene: temperature tolerance -20 ... +75°C, withstands the effects of most oils, acids and solvents. Grey, contains small traces of ink residues and the colour tint may vary.



Storage and picking bins

Treston ReBOX storage bins

Particularly suitable for in-house material flows within factories and warehouses. Material: recycled polypropylene (PP) or semiconductive polypropylene (PP). Standard colour: grey.

External dimensions W x D x H mm	Capacity, litres	Quantity/ package	Code	Code ESD
185 x 490 x 250	12.1	12	1949-30R	1949-4ESD*
310 x 490 x 250	22.6	12	3149-30R	3149-4ESD*

* Made to order. Request a quotation.



Picking bins

All of the inner faces are rounded and the front has a distinctive sloping design which facilitates picking. Bins can be hung on the wall on bin rails, or mounted on workbench bin rails. Material: polystyrene (PS). Standard colour: blue RAL 5015.

External dimensions W x D x H mm	Capacity, litres	Quantity/ package	Code blue	Code ESD
99 x 160 x 70	1.1	60	30-1L-6	30-1L-4ESD
198 x 160 x 70	2.2	30	30-2L-6	30-2L-4ESD
198 x 160 x 70*	2.2	30	30-23L-6	30-23L-4ESD

* includes 2 fixed dividers

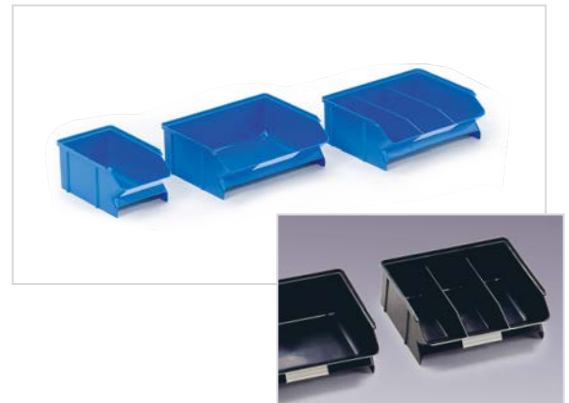

Bin rail

A wall mounting rail for stacking and picking bins. With fixing screws. Made of grey powder coated steel profile.

Length mm	Max load kg	Code
700	50	700



Small drawers

Crystal clear drawers come as standard with self-adhesive labels. Cross and length dividers are available as an accessory. The drawers and their dividers are made of crystal clear polystyrene (PS).

Small drawers

Accessories

	Material	External dimensions W x D x H mm	Internal dimensions W x D x H mm	Capacity, litres	Quantity/ package	Code	Cross divider	Max. amount/bin	Length divider	Max. amount/ bin
	PS	55 x 175 x 37	47 x 146 x 32	0.2	120	L-00	V-00	5 pcs	-	-
	PS	69 x 175 x 37	61 x 146 x 32	0.3	96	L-01	V-01	5 pcs	V-012	1 pcs
	PS	138 x 175 x 37	128 x 146 x 32	0.6	48	L-02	V-02	5 pcs	V-012	3 pcs
	PS	92 x 175 x 59	82 x 146 x 55	0.7	45	L-04	V-04	5 pcs	V-0456	1 pcs
	PS	277 x 175 x 59	266 x 146 x 55	2.1	15	L06	V-06	5 pcs	V-0456	5 pcs
	PS	138 x 175 x 81	128 x 146 x 74	1.4	24	L-07	V-07	5 pcs	V-078	3 pcs

PS = crystal clear polystyrene

Small drawers ESD

Accessories

	Material	External dimensions W x D x H mm	Capacity, litres	Quantity /package	Code ESD	Cross divider	Max. amount/bin
	PS	69 x 170 x 40	0.2	96	L-61-4ESD	V-1-4ESD	5 pcs
	PS	92 x 170 x 62	0.7	45	L-64-4ESD	V-4-4ESD	5 pcs

PS = semiconductive polystyrene

Stacking bin racks

On BR racks, stacking bins are inclined at a 20-degree angle, enabling the excellent presentation of products. They offer an efficient storage system for daily use when small components are required frequently. This product includes a grey steel frame in an epoxy powder-coated finish and seven fixed, forward-sloping storage levels, 930 mm in width. Stacking bins must be ordered separately.

Bin rack

Size W x D x H mm	Max load kg	Code
990 x 500 x 1540	350*	BR-2530
990 x 600 x 1670	350*	BR-4050

*Load capacity 50 kg per level.

Suitable stacking bins

	Bin code	Quantity/ rail pair	Max. quantity/ rack
Bin rack BR-2530	1525	6 pcs	42 pcs
	1930	5 pcs	35 pcs
Bin rack BR-4050	1940	5 pcs	30 pcs
	1950	5 pcs	30 pcs
	3040	3 pcs	18 pcs
	3050	3 pcs	18 pcs

Details of stacking bins can be found on page 202.



1 x stacking bin rack BR-2530
35 x red stacking bin 1930-5



1 x stacking bin rack BR-4050
30 x grey stacking bin 1940-3

TRESTON

BiOX



GS max. 50 kg

GS max. 300 kg

