

ADAPTIVE
DIRECT
FASTENING

DEPRAG

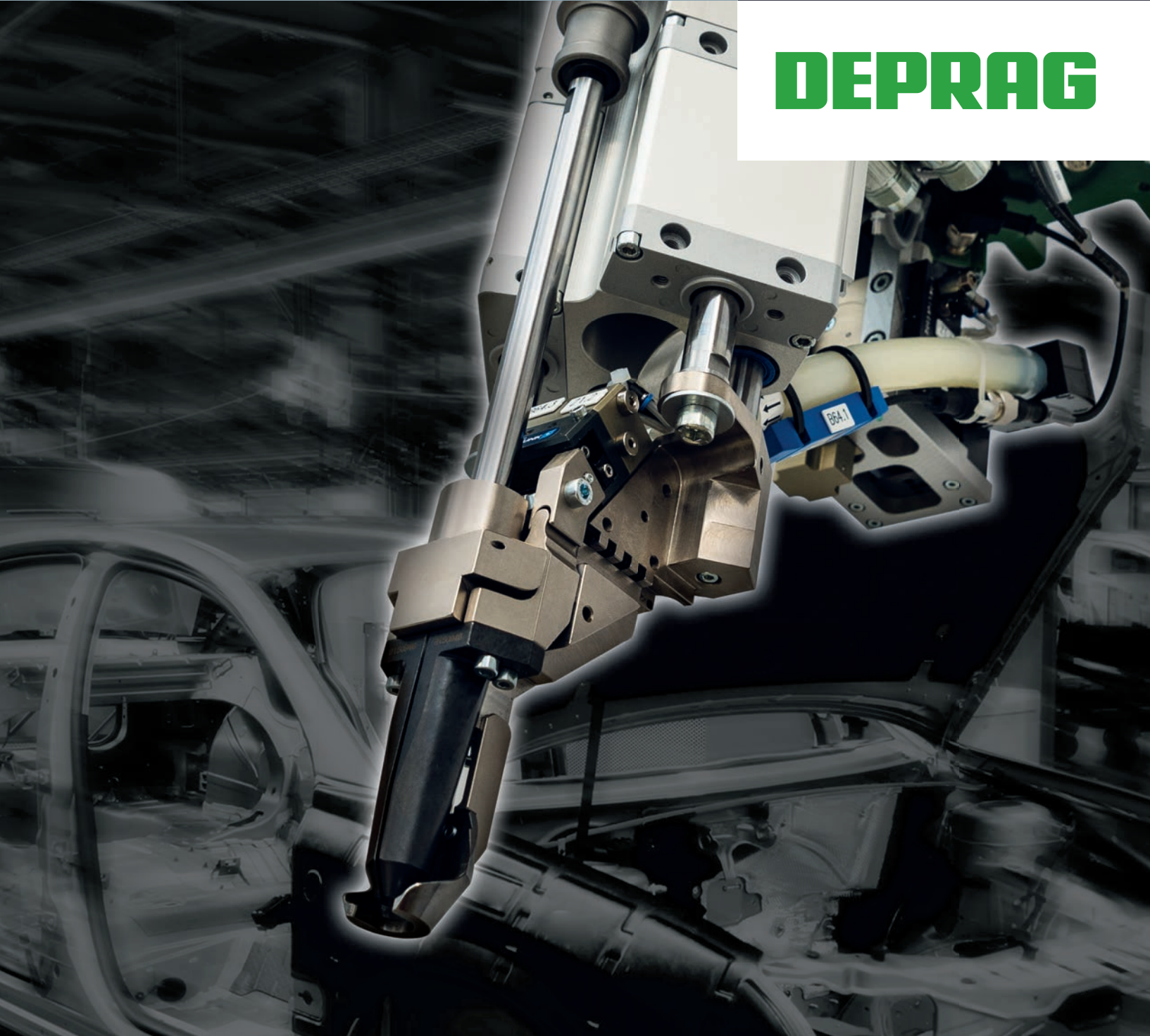

ADAPTIVE DFS
DEPRAG FASTENING SYSTEM

Closed Loop

EC-Servo
screwdriving technology



EC-Servo
stroke technology



ADAPTIVE

The recognition of penetration is independent from tolerances in the fasteners and products. The process parameters will automatically adjust thus resulting in an optimized process.

Advantages:

- Highest process reliability
- Shortest possible cycle time
- Optimized funnel forming
- Avoids thread damages
- Less stress on fastener and product
- Reduces set-up time
- Designed for new materials, fasteners and joining methods

ADAPTIVE DFS

DEPRAG FASTENING SYSTEM

The new adaptive assembly unit **ADAPTIVE DFS** combines **EC-Servo screwdriving technology** with **EC-Servo stroke technology**

The constant data recorded by the control modules enable the precise- and automatic recognition of all relevant penetration points.

Time-critical- and essential parameter changes are autonomously performed by the fastening system. The system ensures the ideal processing parameter, independently from the tolerances of the product or fastener. It significantly reduces the effort of preliminary analysis and parameterization. Costly and extensive repair procedures that are caused by inaccurately formed holes, jammed screws or ruined threads are kept to a minimum.

The best possible processing-parameter that have been automatically adapted to suit any situation, guarantee that the parts to be connected (fastener and product), are subjected to the least amount of strain. The additionally captured processing-data allow an increased process documentation.

Separate electronic controls for the EC-Servo screwdriver and the EC-Servo stroke technology, in combination with the extensive parameterization possibilities, ensure the highest flexibility during the processing of multiple materials. The implementation of special tightening sequences for new fasteners and materials is possible. Especially for the assembly of future materials such as carbon-fiber and CFRP, the controlled feed stroke allows that exact positioning and trigger-points are clearly defined.

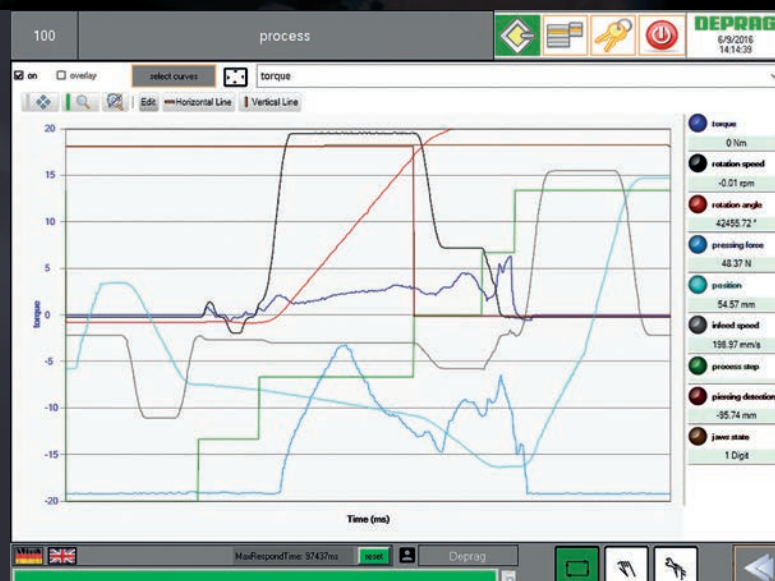

ADAPTIVE DFS Software

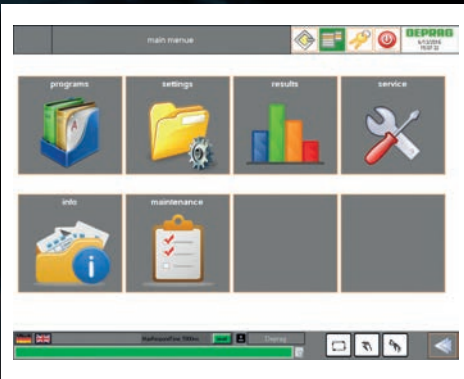

HMI main menu

- Intuitive operator guidance
- Extensive functions

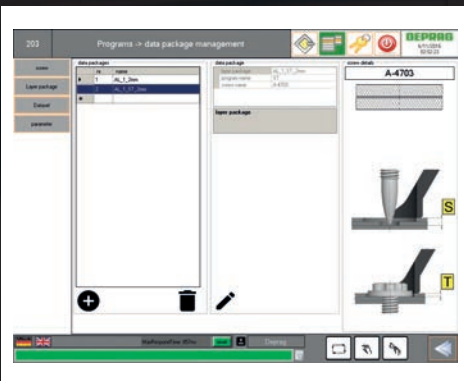

Programs

- Unlimited parameterization of assembly sequences, fasteners and materials
- Archiving of assembly sequences
- Unlimited data storage

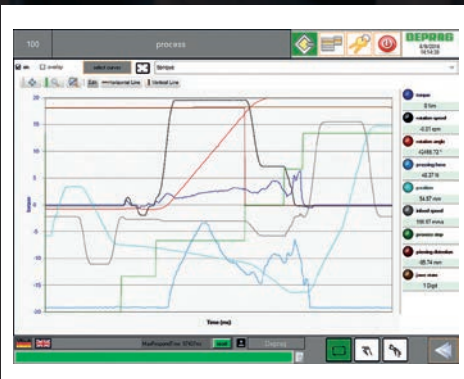

Results and data management

- Graph overlaying for trend analysis
- Archiving of parameters and results

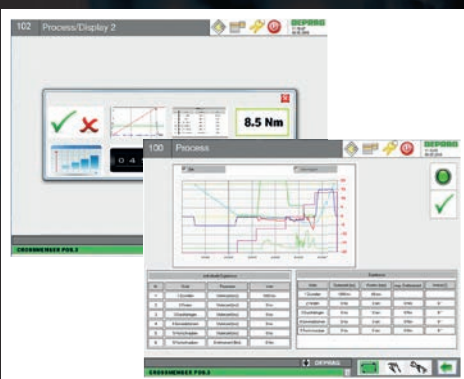

Customized results display

- Generate your very own results data screen

ADAPTIVE DFS

DEPRAG FASTENING SYSTEM

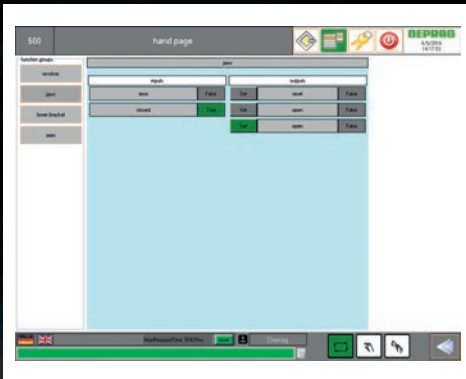

Service

- Test of function modules
- Test of system status
- I/O test

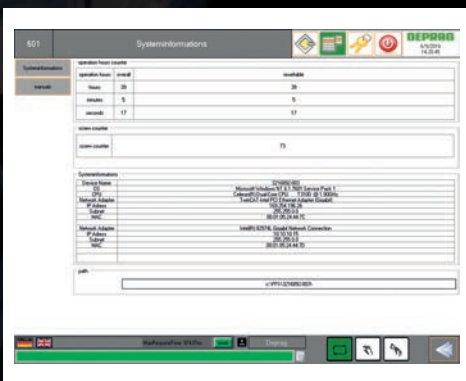

Info

- System data
- Manuals

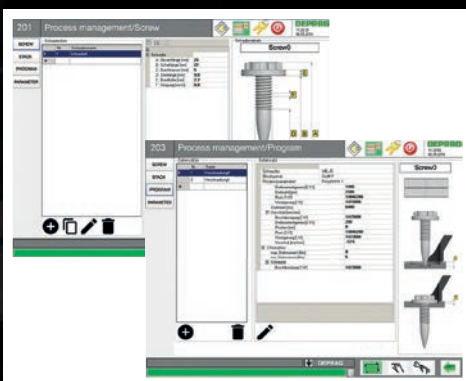

Settings

- User administration
- 13 languages
- System settings



Attention: Preset cycles reached
▶ Check socket for wear,
exchange if needed



Attention: Preset cycles reached
▶ Clean mouthpiece and
nosepiece jaws



Attention: Preset cycles reached
▶ Inspect timing belt,
exchange if wear is visible

Maintenance

- Preset preventive maintenance operations
- Generate your own preventive maintenance operations



ADAPTIVE DFS Features

**EC-Servo
screwdriving technology**



**EC-Servo
stroke technology**



Adaptive fastening

- Automated adjustment of parameters
- Highest process security
- Shortest possible cycle time

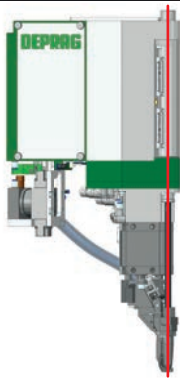

Thrust applied to the center of the assembly axis

- Direct transfer of thrust into the assembly axis
- No lateral forces on guide mechanism, etc.
- Lightweight design
- Less wear and tear

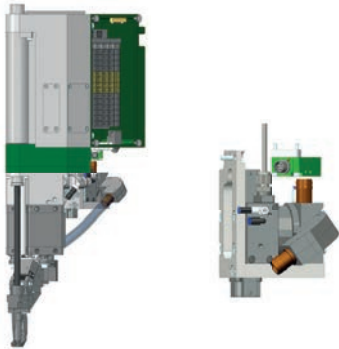

„Head first“ feeding principle

- No damage to the screws' tip and threads
- Screw preload function (buffer) optimizes the cycle time

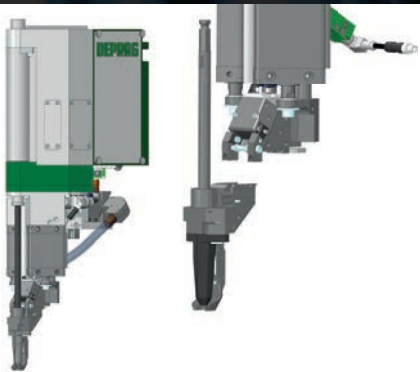

Interchangeable mouthpiece without tools

- No need to disconnect any cables or hoses
- 1. Push release button
- 2. Pull off mouthpiece

ADAPTIVE DFS

DEPRAG FASTENING SYSTEM

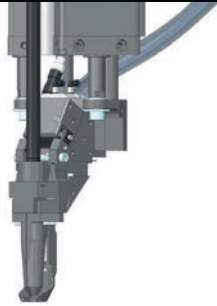

Actively controlled jaws

Cylinder activated jaws

- Perfect alignment of screw
- Less wear and tear



Lock stroke for underneath applications

- Socket automatically moves behind the fastener and keeps it in position



Connection to robot

- From top
- From backside



Feeding technology

- Blow feeding
- On-board magazine

ADAPTIVE DFS Features



Support tools to assist during commissioning

- Tripod, adjustable: support manual alignment procedures, i.e. on curved surfaces
- Mounts to quick-change chuck
- Documentation of assembly space and position possible through camera

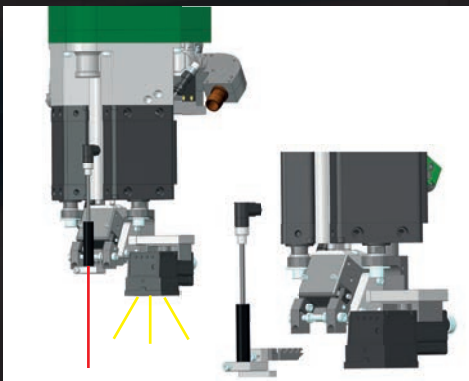

Support tools to assist during commissioning

- Laser pointer for fast and precise teach in process, laser mounts to quick-change chuck
- Vision system with cross lines
- Documentation of assembly space and position possible through camera

Technical data

- Speed: max. 8000 rpm
- Torque: max. 15 Nm
- Feed stroke force: max. 3500 N, freely programmable
- Feed stroke freely programmable: Speed, distance and force monitoring and controlling
- Downholder force: max. 1200 N, freely programmable
- Weight: 35 kg
- Assembly directions: any (from above, underneath, at any angle)



ADAPTIVE DFS

DEPRAG FASTENING SYSTEM

Housing with feed stroke module



Controls module

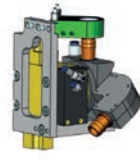
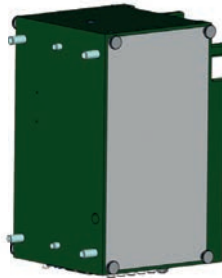

Separator

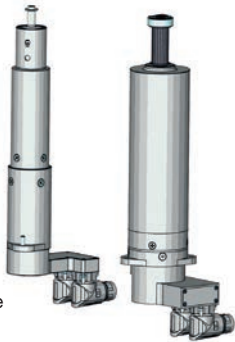

Feed stroke motor

Screwdriving motor

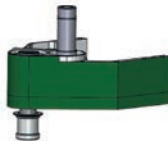

Belt drive

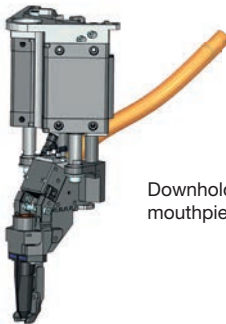

Downholder incl. mouthpiece



Socket

Maintenance friendly

- Modular design
- Trending information at the HMI
- Recording, analyzing and displaying of load results and data
- Quick-change connectors for all media
- Quick-change adapters for many robot brands and models

ADAPTIVE DFS Integration

Interface ADAPTIVE DFS ↔ Robot

PLC - Input / Robot - Output		PLC - Output / Robot - Input	
Signal	Description	Signal	Description
0.01	Start process feed System on	0.01	Start process feed System on
0.02	Start process feed System off	0.02	Start process feed System off
0.03	Start process feed System error	0.03	Start process feed System error
0.04	Start process feed System stop	0.04	Start process feed System stop
0.05	Start process feed System ready	0.05	Start process feed System ready
0.06	Start process feed System alarm	0.06	Start process feed System alarm
0.07	Start process feed System emergency	0.07	Start process feed System emergency
0.08	Start process feed System maintenance	0.08	Start process feed System maintenance
0.09	Start process feed System stop	0.09	Start process feed System stop
0.10	Start process feed System ready	0.10	Start process feed System ready
0.11	Start process feed System alarm	0.11	Start process feed System alarm
0.12	Start process feed System emergency	0.12	Start process feed System emergency
0.13	Start process feed System maintenance	0.13	Start process feed System maintenance
0.14	Start process feed System stop	0.14	Start process feed System stop
0.15	Start process feed System ready	0.15	Start process feed System ready
0.16	Start process feed System alarm	0.16	Start process feed System alarm
0.17	Start process feed System emergency	0.17	Start process feed System emergency
0.18	Start process feed System maintenance	0.18	Start process feed System maintenance
0.19	Start process feed System stop	0.19	Start process feed System stop
0.20	Start process feed System ready	0.20	Start process feed System ready
0.21	Start process feed System alarm	0.21	Start process feed System alarm
0.22	Start process feed System emergency	0.22	Start process feed System emergency
0.23	Start process feed System maintenance	0.23	Start process feed System maintenance
0.24	Start process feed System stop	0.24	Start process feed System stop
0.25	Start process feed System ready	0.25	Start process feed System ready
0.26	Start process feed System alarm	0.26	Start process feed System alarm
0.27	Start process feed System emergency	0.27	Start process feed System emergency
0.28	Start process feed System maintenance	0.28	Start process feed System maintenance
0.29	Start process feed System stop	0.29	Start process feed System stop
0.30	Start process feed System ready	0.30	Start process feed System ready
0.31	Start process feed System alarm	0.31	Start process feed System alarm
0.32	Start process feed System emergency	0.32	Start process feed System emergency
0.33	Start process feed System maintenance	0.33	Start process feed System maintenance
0.34	Start process feed System stop	0.34	Start process feed System stop
0.35	Start process feed System ready	0.35	Start process feed System ready
0.36	Start process feed System alarm	0.36	Start process feed System alarm
0.37	Start process feed System emergency	0.37	Start process feed System emergency
0.38	Start process feed System maintenance	0.38	Start process feed System maintenance
0.39	Start process feed System stop	0.39	Start process feed System stop
0.40	Start process feed System ready	0.40	Start process feed System ready
0.41	Start process feed System alarm	0.41	Start process feed System alarm
0.42	Start process feed System emergency	0.42	Start process feed System emergency
0.43	Start process feed System maintenance	0.43	Start process feed System maintenance
0.44	Start process feed System stop	0.44	Start process feed System stop
0.45	Start process feed System ready	0.45	Start process feed System ready
0.46	Start process feed System alarm	0.46	Start process feed System alarm
0.47	Start process feed System emergency	0.47	Start process feed System emergency
0.48	Start process feed System maintenance	0.48	Start process feed System maintenance
0.49	Start process feed System stop	0.49	Start process feed System stop
0.50	Start process feed System ready	0.50	Start process feed System ready
0.51	Start process feed System alarm	0.51	Start process feed System alarm
0.52	Start process feed System emergency	0.52	Start process feed System emergency
0.53	Start process feed System maintenance	0.53	Start process feed System maintenance
0.54	Start process feed System stop	0.54	Start process feed System stop
0.55	Start process feed System ready	0.55	Start process feed System ready
0.56	Start process feed System alarm	0.56	Start process feed System alarm
0.57	Start process feed System emergency	0.57	Start process feed System emergency
0.58	Start process feed System maintenance	0.58	Start process feed System maintenance
0.59	Start process feed System stop	0.59	Start process feed System stop
0.60	Start process feed System ready	0.60	Start process feed System ready
0.61	Start process feed System alarm	0.61	Start process feed System alarm
0.62	Start process feed System emergency	0.62	Start process feed System emergency
0.63	Start process feed System maintenance	0.63	Start process feed System maintenance
0.64	Start process feed System stop	0.64	Start process feed System stop
0.65	Start process feed System ready	0.65	Start process feed System ready
0.66	Start process feed System alarm	0.66	Start process feed System alarm
0.67	Start process feed System emergency	0.67	Start process feed System emergency
0.68	Start process feed System maintenance	0.68	Start process feed System maintenance
0.69	Start process feed System stop	0.69	Start process feed System stop
0.70	Start process feed System ready	0.70	Start process feed System ready
0.71	Start process feed System alarm	0.71	Start process feed System alarm
0.72	Start process feed System emergency	0.72	Start process feed System emergency
0.73	Start process feed System maintenance	0.73	Start process feed System maintenance
0.74	Start process feed System stop	0.74	Start process feed System stop
0.75	Start process feed System ready	0.75	Start process feed System ready
0.76	Start process feed System alarm	0.76	Start process feed System alarm
0.77	Start process feed System emergency	0.77	Start process feed System emergency
0.78	Start process feed System maintenance	0.78	Start process feed System maintenance
0.79	Start process feed System stop	0.79	Start process feed System stop
0.80	Start process feed System ready	0.80	Start process feed System ready
0.81	Start process feed System alarm	0.81	Start process feed System alarm
0.82	Start process feed System emergency	0.82	Start process feed System emergency
0.83	Start process feed System maintenance	0.83	Start process feed System maintenance
0.84	Start process feed System stop	0.84	Start process feed System stop
0.85	Start process feed System ready	0.85	Start process feed System ready
0.86	Start process feed System alarm	0.86	Start process feed System alarm
0.87	Start process feed System emergency	0.87	Start process feed System emergency
0.88	Start process feed System maintenance	0.88	Start process feed System maintenance
0.89	Start process feed System stop	0.89	Start process feed System stop
0.90	Start process feed System ready	0.90	Start process feed System ready
0.91	Start process feed System alarm	0.91	Start process feed System alarm
0.92	Start process feed System emergency	0.92	Start process feed System emergency
0.93	Start process feed System maintenance	0.93	Start process feed System maintenance
0.94	Start process feed System stop	0.94	Start process feed System stop
0.95	Start process feed System ready	0.95	Start process feed System ready
0.96	Start process feed System alarm	0.96	Start process feed System alarm
0.97	Start process feed System emergency	0.97	Start process feed System emergency
0.98	Start process feed System maintenance	0.98	Start process feed System maintenance
0.99	Start process feed System stop	0.99	Start process feed System stop
1.00	Start process feed System ready	1.00	Start process feed System ready

Hand shake with robot

- Communication via bus or I/O
- External access to individual process steps, i.e. the screw feeding process
- Extensive data exchange available



Media management

- Quick-change connectors on the ADAPTIVE DFS
- Customized cable configuration



Feeding technology

- Sword feeder
- Vibration bowl feeder of the new generation eacy feed
Both options operate independent of power supply (110-240V, 50-60Hz) for international use without adjustment.
- Belt hopper with up to 20l fill capacity



DPU200

The DPU200 is the most efficient controller of the DPU series. The controller has a 15" display with XGA resolution (1024 x 768 pixels) for optimized image visualization.

- Industrial PC
Operating system: Windows 7 Ultimate



Control cabinet

- Operating voltage: 3/(N)/PE 400-480V, 50-60Hz



DEPRAG

Your worldwide partner for
screwdriving technology and
automation

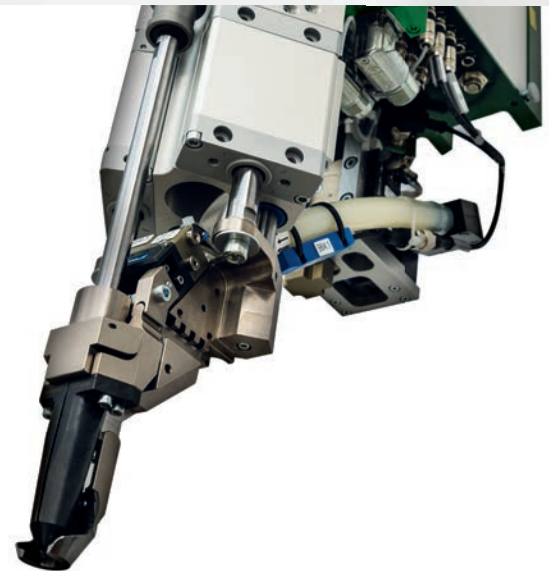

More information:
www.deprag.com