



ASSORTIMENT INDUSTRIËLE STOELLEN

 **Screwdriving technology**

 **Workspace Organisation**

 **Safety & Ergonomics**



Your Assembly Workspace Partner

Correct posture for employees of industrial companies and laboratories

Our complete catalogue „Work chairs for industrial companies and laboratories“ is more than just a product overview. We act as a partner to our customers and wish to share our knowledge of seating in production, ESD, laboratory, clean room and standing workstations. This catalogue should therefore be a valuable tool for planning your working environment. We show you what is important in the different areas and provide you with solutions to a large number of application-specific, ergonomic and design challenges in the workplace.

Our main goal is to help you provide your employees with productive, healthy and pleasant seating at every workstation.

Contents

To make it easier to use and in the interests of clarity our catalogue uses a colour-coding system for the various application areas covered.

Useful facts

Useful facts about Bimos and what makes a good workplace chair

We are Bimos	6-7
We have the perfect solution	8-9
Five sustainability guidelines	10-11
A good workplace chair	12-15
Functions and ergonomics	16-17
Everything you need to know about chairs	148
Options guide	149
Guide to finishes	150-151
Dimensions	152-154







Production

Perfect seating solutions for production facilities 18-21

	Neon	22-29	New generation workplace chairs
	Sintec	30-35	The tried and tested solution for custom seating
	Nexxit	36-41	Your perfect partner at work
	All-In-One	42-47	The all-inclusive seating solution
	Isitec	48-51	The practical solution for everyday use
	Unitec	52-55	The low-cost solution for solid performance
	Stools	56-57	Industrious assistants
	Footrests	58-59	Providing support in your everyday work
	Sintec 160	60-61	The workplace chair for people up to 160 kg





ESD area

Reliable electrostatic discharge protection for electronic workstations 62-65

	ESD Neon	66-71	New generation workplace chairs
	ESD Sintec	72-77	The tried and tested solution for custom seating
	ESD Nexxit	78-81	Your perfect partner for ESD areas
	ESD Basic	82-85	The tried and tested all-rounder for use in ESD areas
	ESD Unitec	86-89	The low-cost solution for solid performance
	Stools/footrests for ESD areas	90-91	Industrious assistants



Laboratory

Sophisticated seating solutions for your laboratory 92-95

	Labster	96-99	The world's first real laboratory chair
	Neon Laboratory	100-105	Comfort in your laboratory
	Labsit	106-111	Simple is clever
	Nexxit Laboratory	112-115	Your perfect partner in the laboratory
	Basic Laboratory	116-119	The tried and tested all-rounder for use in laboratories

Cleanroom

Indispensable - top-class certified solutions for the cleanroom 120-123

	Cleanroom Plus	124-127	The comfortable option for great performance in the cleanroom
	Cleanroom Basic	128-131	The tried and tested all-rounder for use in cleanrooms
	Cleanroom stools	132-133	Industrious assistants

Standing work

Relief from stress and strain for people who cannot sit down to work 134-137

	Fin/ESD Fin	138-141	The revolution in standing work
	Labster standing rest for laboratory, cleanroom and ESD	142-143	Standing rest for laboratory - and more
	Industrial standing rest/ESD standing rest	144-145	Support for your everyday work
	Flex	146-147	The best support for sitting, standing and combined workplaces

We are Bimos

Bimos is the leading manufacturer of top-quality industrial and laboratory chairs in Europe. For over 50 years, the specialist knowledge, technical expertise and passion that go into our chairs have ensured that staff are productive, healthy and comfortable in any workplace. No other brand has our level of knowledge on the topic of seating and its practical requirements. We understand our customers' requirements. Bimos combines competent consulting with uncompromising reliability. We are driven by consistent thinking about solutions. This makes us the leader in innovative chairs for industrial companies and laboratories. By maintaining close contact with daily users and ergonomic developments, we are able to quickly develop products that are tailored to meet customers' requirements. Thanks to our extensive product portfolio and flexible options, we are able to produce optimal products at the best possible price.

The ergonomic requirements of work chairs in industrial companies and laboratories are fundamentally different to those in other sectors. We therefore apply our own ergonomic concepts specifically designed for industrial companies and laboratories. Good design is an expression of a modern working environment and a sign of respect and motivation for employees. This is why we think of technology and design as an all-in-one solution. We are also convinced that good products are only truly good if they have been produced in a positive way. We have therefore made it our mission to handle every kind of resource, from ecological to social and economic ones, with extreme care.

Bimos stands for passion, thinking in terms of solutions and life.



We have the perfect solution

for every requirement ...

... and every conceivable workplace

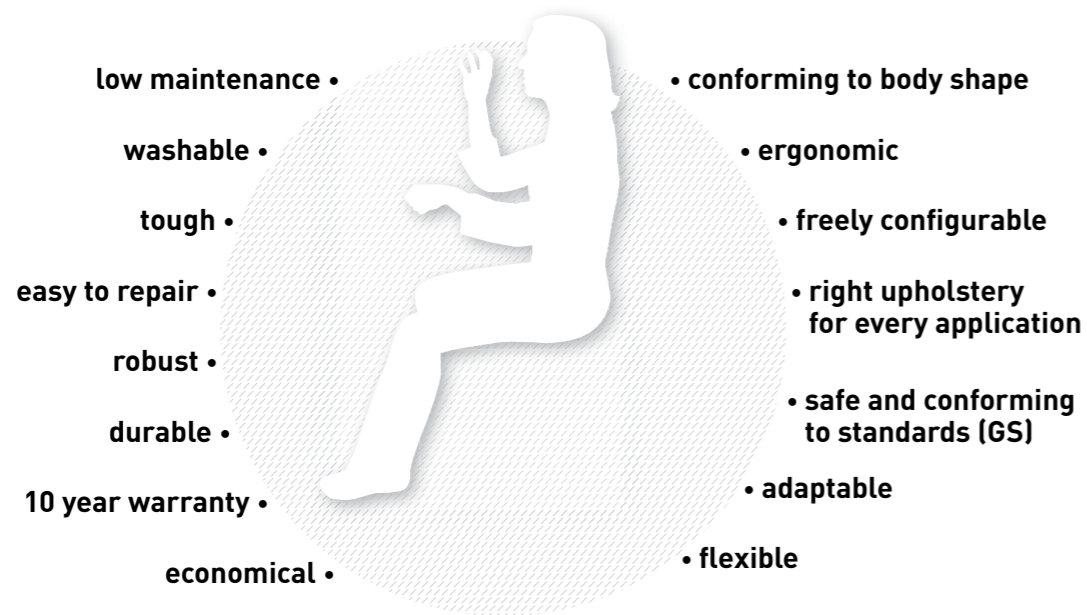

New technical developments constantly make fresh demands of workplace chairs, which is why we invest so much energy in research. This means maintaining close contact with practitioners, and co-operating with various experts, for instance from the Fraunhofer Institute.

Even the best chair can only really be effective when it is completely self-explanatory, and when the user wants to use it. This is why we work with the best product designers in Germany.

Innovation must never be to the detriment of safety, quality or sustainability. Compliance with standard DIN 68 877, the GS tested safety mark, certification in accordance with

DIN EN ISO 9001, environmental management in accordance with DIN EN ISO 14001 and EMAS regulation, and last but not least, our ten year warranty are all clear proof of just how committed we are in this respect.

In addition to the innovation, quality and sustainability of our products, we are also extremely proud of our modular seating concepts. The perfect specialist solution for every working environment is right here.

Just let us know what you need.
We have the solution.



Five guidelines ...

... for sustainability

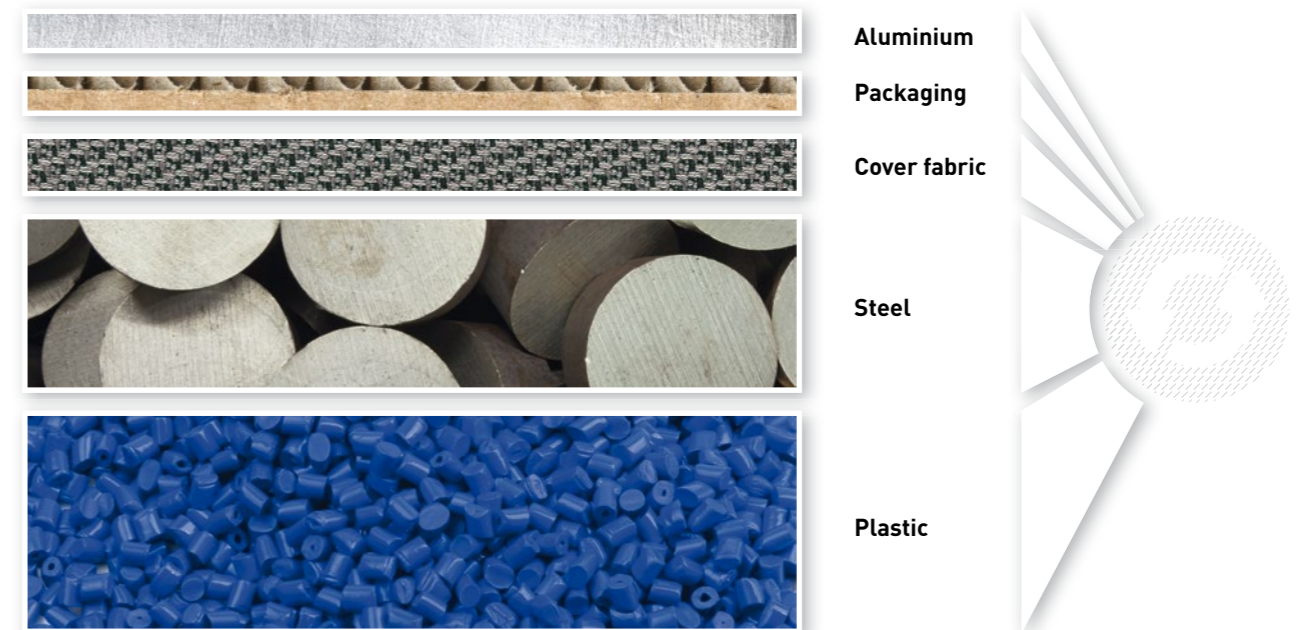

Average usage of materials in a workplace chair

We are committed to responsible use of resources and to the world in which we live. We were one of the first companies in our sector to receive certification according to EMAS, in 1995. Our commitment to sustainability was acknowledged in 2010 with the Environmental Award for Businesses from the State of Baden-Württemberg. Neon is the first workplace chair to have been awarded the Blue Angel eco-label.

The following five guidelines underlie every single new Bimos development:

Recycling starts at the development stage

Our seating solutions are designed in such a way that almost complete material recovery is possible. To ensure this, we avoid – wherever possible – using composite materials. Recycled materials are always preferred in the manufacture of our chairs.

Quality is the best protection for resources

Nothing is better for the environment than a product which does not have to be replaced. When we develop a product, one of our principal aims is to ensure it has a really long life.

Modular design as service-plus

Our chairs are designed so that all components can be simply and quickly replaced at any time, and we ensure that our replacement parts are available for at least 10 years.

Green values in black and white

Every one of our chairs comes with an environmental data sheet. This shows the key environmental parameters of all components: from the humble screw to the upholstery.

Our chairs have a green home

Even in areas not directly related to what we produce, we are continually optimising our processes, and working to ensure that we remain at the forefront of environmental awareness.

A good workplace chair ...

... can increase efficiency at your company

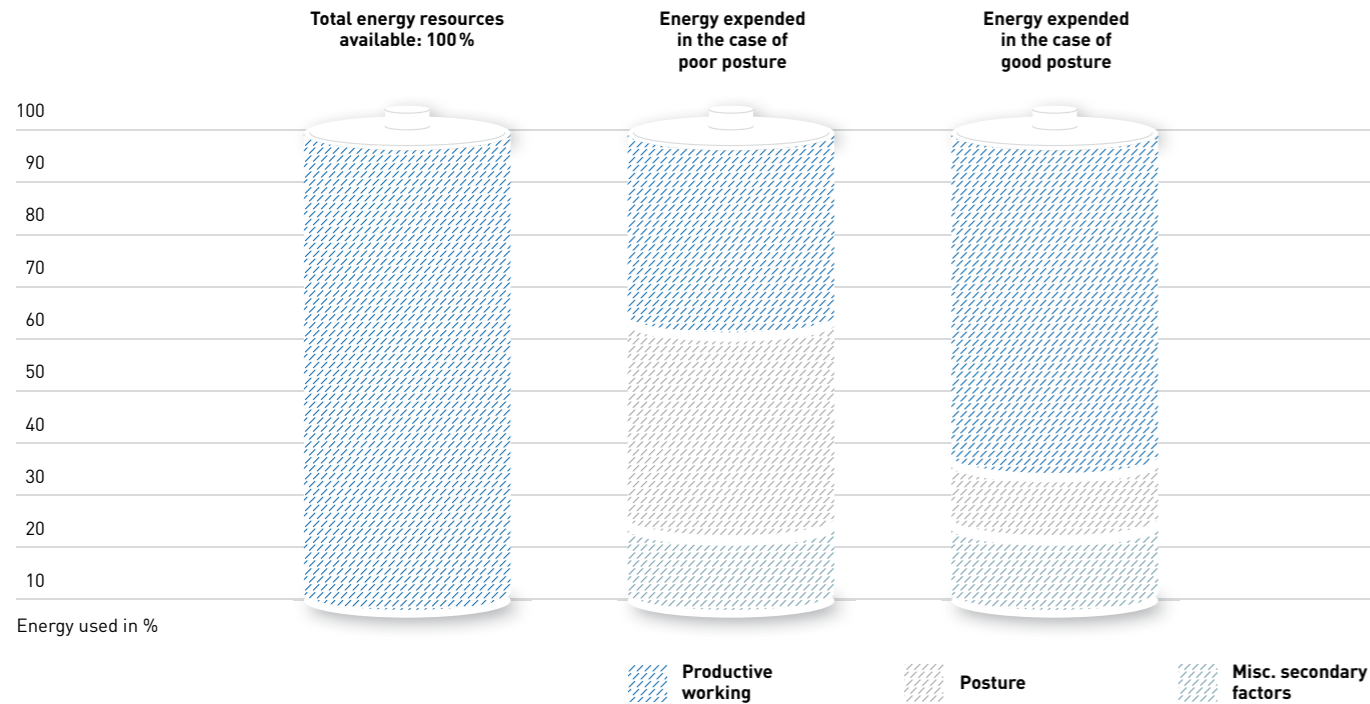

Economy means making the best use of energy

Research shows that up to 40% of people's productivity at work can be lost through poor posture. When the body is under strain, it has to compensate for any deficiencies in the workplace. That requires strength and energy that can be put to better use in working, rather than wasting them on sitting. So the influence of a workplace chair on the productivity of a company is enormous.

A good workplace chair supports the sitter, and prevents a person from getting tired quickly. This improves both performance and concentration. Errors can be reduced by up to 20%.

Economy means when long-term investment pays off

The quality of a good workplace chair is evident in its materials and craftsmanship as much as in its basic concept. Bimos seating solutions are very well aware of this. Long-term durability, replaceable individual parts, and the possibility of purchasing individual components at any time combine to give you maximum flexibility.

Bimos exclusively uses materials that have been subjected to rigorous testing. We were the first German manufacturer of workplace chairs to fulfil all the requirements of the standard DIN ISO 9001. We are so confident of the quality of our products that we give all our chairs a warranty of ten years.

- boost the performance of your staff
- raise the quality of work
- invest in the future

... ensures safety in the workplace

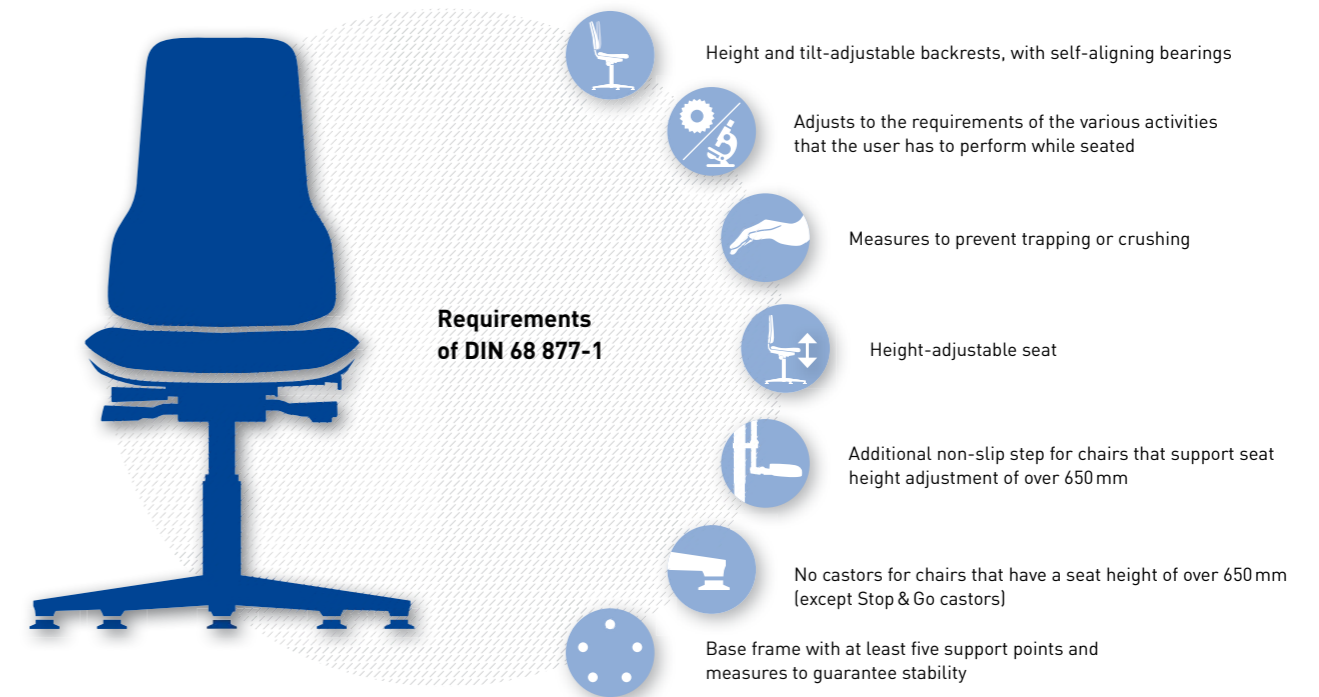

We abide by all safety guidelines ...

A good workplace chair must become an integral part of your company's health and safety arrangements. This applies to the way in which the chair is constructed, but it is just as important that the chair is perfectly suited for the tasks it is required to fulfil in your company. Yet the truth is that you often find chairs in an industrial setting that are not suitable for use there, e. g. office chairs.

Naturally, all Bimos chairs fulfil standard DIN 68 877-1 and all carry the GS safety mark for tested safety. But the safety requirements we demand of our chairs go far beyond those given in the standard.

... and we are still not satisfied.

At Bimos, we anticipate every possible danger of injury, and prevent it from happening. We are in constant contact with experts in the field, and co-operate with well-respected research organisations such as the Fraunhofer Institute.

In addition to our solid construction and safe mechanisms, it is vital in industry that a chair should take account of the human safety factor. If humans cannot work in a relaxed and concentrated manner, then that is when dangerous mistakes can be made. The only chair that promotes safety in your company is a chair that takes the strain.

- safety depends on purpose
- don't cut corners on safety
- prevent accidents before they happen

A good workplace chair ...

... protects the health of your employees

The amount of money lost through a single day's illness



Approx. € 500,-

A single lost working day will actually cost you more than purchasing an ergonomic chair!

The amount of money required to purchase an ergonomic workplace chair

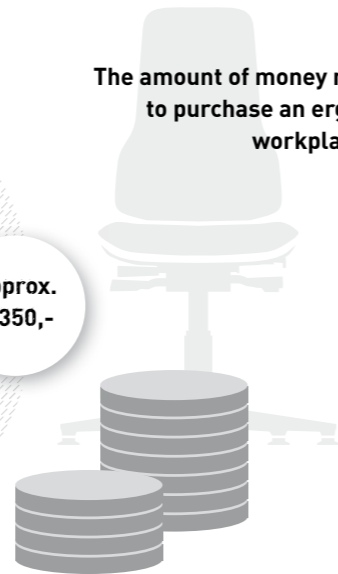

Approx. € 350,-

Protect your most valuable asset

The most valuable asset of any company is its staff. It is becoming more and more apparent that people's health can be affected by their work. Back pain is a frequent problem. Work outside the office environment makes special demands of a workplace chair. This is the point at which we should mention forward-leaning sitting posture. Our chairs support this posture, reducing the likelihood of muscle tension and circulation problems. Back pain in the lumbar region, pain in the neck and shoulders, headache, and swollen legs can also be effectively prevented. Bimos also has perfect solutions for activities that have to be carried out while standing up.

Invest in the health of your staff and save cash

Good workplace chairs relieve stress, help to correct postural problems, and so prevent injury from poor posture. They support the muscular system and are the most effective way of protecting the body against stresses and strains.

Once a person has back pain, it is likely to necessitate a relatively long time off work. With a good workplace chair you will find that costs arising from absence on sick leave will reduce significantly: one single day off sick costs more than an ergonomic chair. In addition to avoiding sick leave, a good workplace chair ensures that staff feel good at work, and promotes concentration and performance.

- protect your human resource
- successful health promotion begins with sitting
- stress-free working is the only healthy working

... is a competitive advantage

bimos



A range designed to bring you pure pleasure: Seating solutions from Bimos

Satisfaction comes from being valued

An employee spends longer on average sitting on a chair every day than lying in bed. So a good workplace chair is a measure of the value you place on the people in your company. Particularly today when development and production workplaces are merging closer together, and such a "war for talent" is raging, good workplaces are becoming an indispensable tool for motivating your staff. In addition to health and practical aspects, comfort plays a huge role too. The touch and feel of a workplace, too, have a great influence on its perceived value.

Nothing shapes a workplace so much as the chair

The chair is the workplace. You feel good sitting on a good chair. Nothing pinches, nothing nips. It is comfortable, it supports you, and it doesn't force you to sit in a fixed position. A good chair adapts perfectly to a person and to a workplace. It supports the body even when a person is doing heavy physical work.

A good chair makes a massive contribution to people's happiness at work. At Bimos, we want to give people this happiness: that's why we develop our chairs from one viewpoint only – that of the human being.

- comfort is not a luxury
- people only work well if they are sitting comfortably
- improve your work environment with good chairs

Functions and ergonomics

Adjust the chair, not the person

Production work makes huge demands on the workplace: people may be using a great deal of energy, they may be precision-working, or making repetitive movements. A workplace chair should not force the user to sit in a constrained position. It must suit its environment perfectly, must be adapted to the work involved, and above all must be adjustable to every person sitting on it. The human body is the measure. A workplace chair must be an equally good fit for anyone and everyone – men and women, small people and large, heavy and light, and young and old – which is why it is essential to have a sufficiently wide range of settings and adjustments.

Important functions for adjustment to individual body size

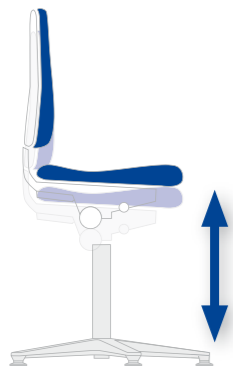

Seat height adjustment

Seat height adjustment allows adjustment to body size and height of workplace. The ideal seat height is when the knees, hips and elbows form an angle of at least 90°, with the feet resting flat on the floor.



Seat tilt adjustment

Many jobs are carried out in slightly raised positions, and require people to bend forward. A correspondingly tilted seat provides a seat angle of at least 90°, while at the same time providing contact with the backrest.



Seat depth adjustment

The seat depth adjustment matches the depth of the seat to the size of the body, giving the best possible contact surface for the thighs. Contact with the backrest, and therefore the support it provides, are maintained.

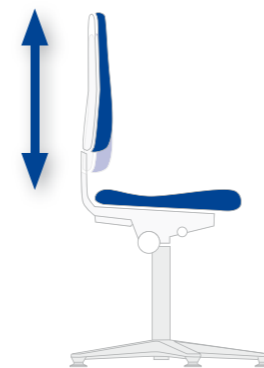

Backrest height adjustment

The backrest height adjustment ensures that a person is ideally supported – especially in the lumbar region – no matter how tall he/she is.



Weight regulation

By individually adjusting the pressure of the backrest, both light and heavy people can sit with the correct posture.

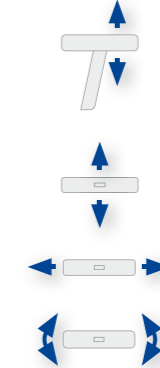

Armrests

Armrests have the important function of reducing the strain on the upper body and arms. The height, breadth and depth of our 4D armrests can be adjusted, and can also be swivelled

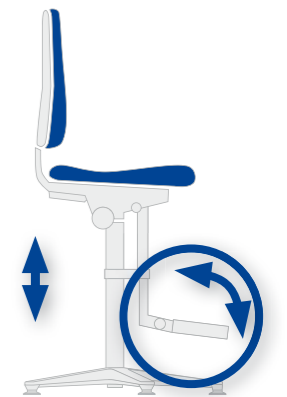

Foot support and mounting aid

The mounting aid is height-adjustable, and can be folded upwards by 90°.

Choice of two mechanisms for active-dynamic sitting

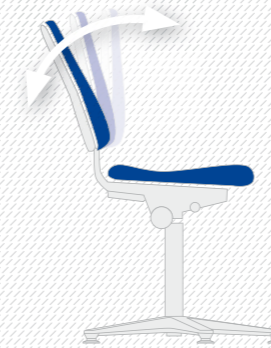

The permanent contact backrest ...

... follows the movements of the upper body, and ensures that the back always remains fully supported. The permanent contact backrest is ideal for people who have to lean forward for long periods of time, with only a small distance between eyes and workpiece (e.g. working in precision engineering or in the laboratory).



Synchronous technology ...

... provides an active-dynamic sitting experience with weight regulation. The seat and backrest accompany the body as it moves. This gives the user a feeling that can best be described as "weightless floating". The synchronous technology comes into its own where users are working at office-type working situations, working at a screen, or constantly changing their sitting position.

Production

“The chair is the most important piece of equipment in the world of production.”

 +32 (0)9 232 06 78

 info@awp.be

 Destelbergen



Production

Perfect seating solutions for production facilities

A workplace chair can only really be described as “good” if it fits in perfectly with the working environment. Each type of activity imposes its own particular requirements. That is why a good office chair will be designed to suit the working conditions found in offices. A chair that is to be used within a production context, on the other hand, will need to meet a completely different set of demands. Bimos workplace chairs are setting new standards in this respect. They manage to combine maximum freedom of movement and adaptability with super sturdiness. From the ergonomic design of the seat and backrest and easily replaceable upholstery right through to the highly durable materials used, our seating solutions are the epitome of good design. As a result, not only do they satisfy the necessary standards, but are always developed in close collaboration with industrial doctors and other specialists in the field.



The activity determines the chair

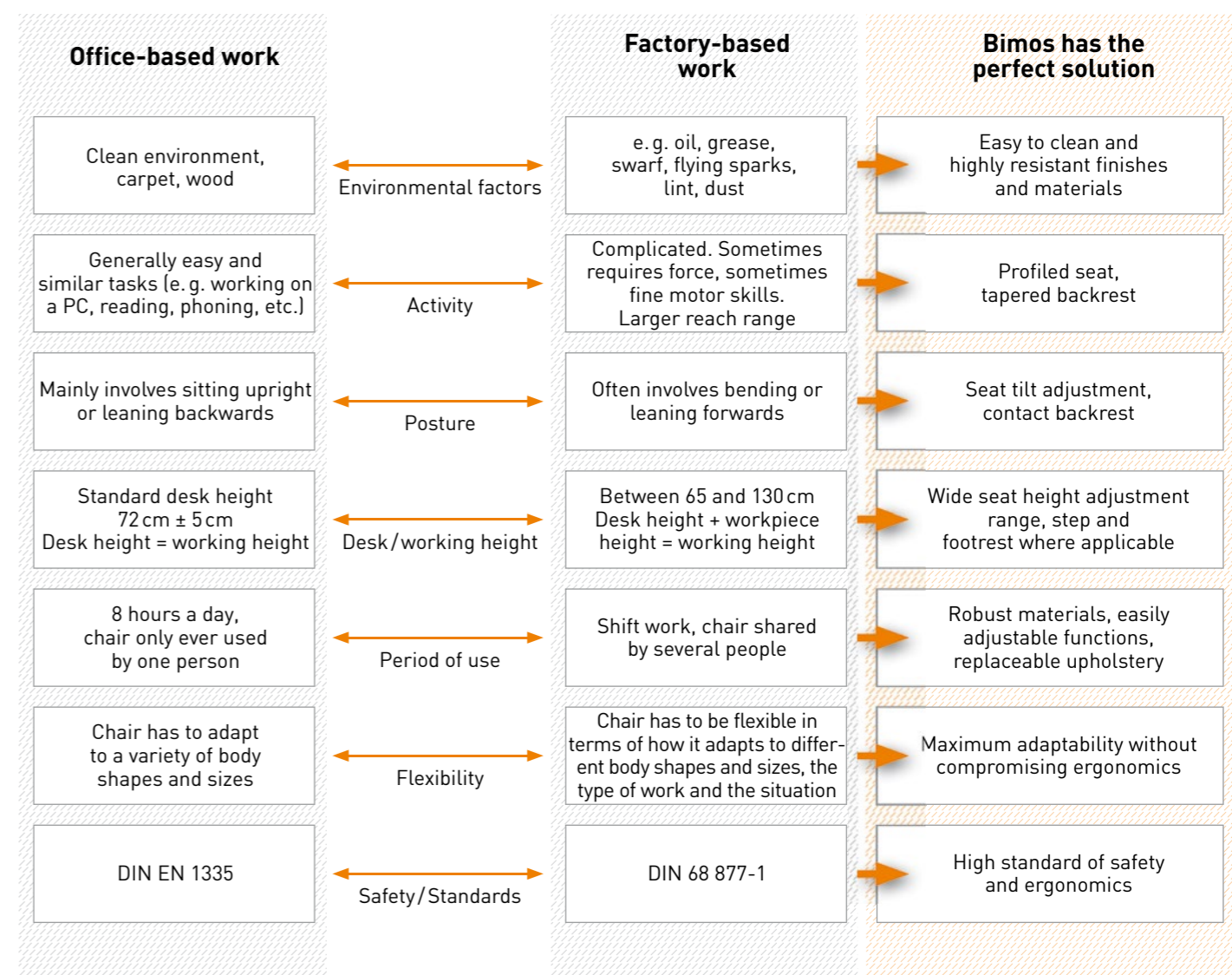

Neon

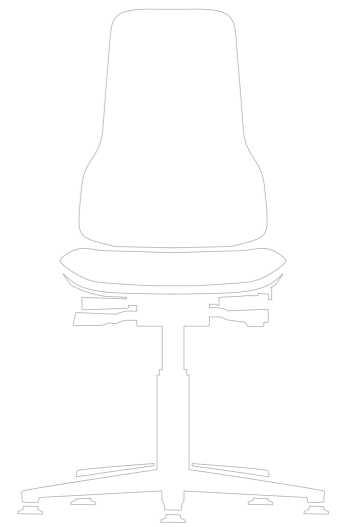

New generation workplace chairs

Neon is the flagship for modern industry. No other chair for use in manufacturing can boast such ergonomic features, such design or such comfort. Neon is based on findings from the Fraunhofer Institute's Arbeitswelt 2015plus research. So Neon is the new generation workplace chair for the new generation of work. Simple production jobs are increasingly being replaced by

more complicated tasks. Similarly, office and manufacturing workplaces are merging closer and closer together, and demands on the workplace are increasing. Neon combines ergonomic and functional characteristics that have until now been unknown in production environments with optimum industrial characteristics. Its innovative 1+1 system of chair and upholstery combination provides flexibility and sustainability, and ensures that it is perfectly adapted to the particular area of work. Both operating Neon and sitting on it are highly comfortable experiences. Neon was designed by Phoenix Design, arguably the best design studio in Germany.

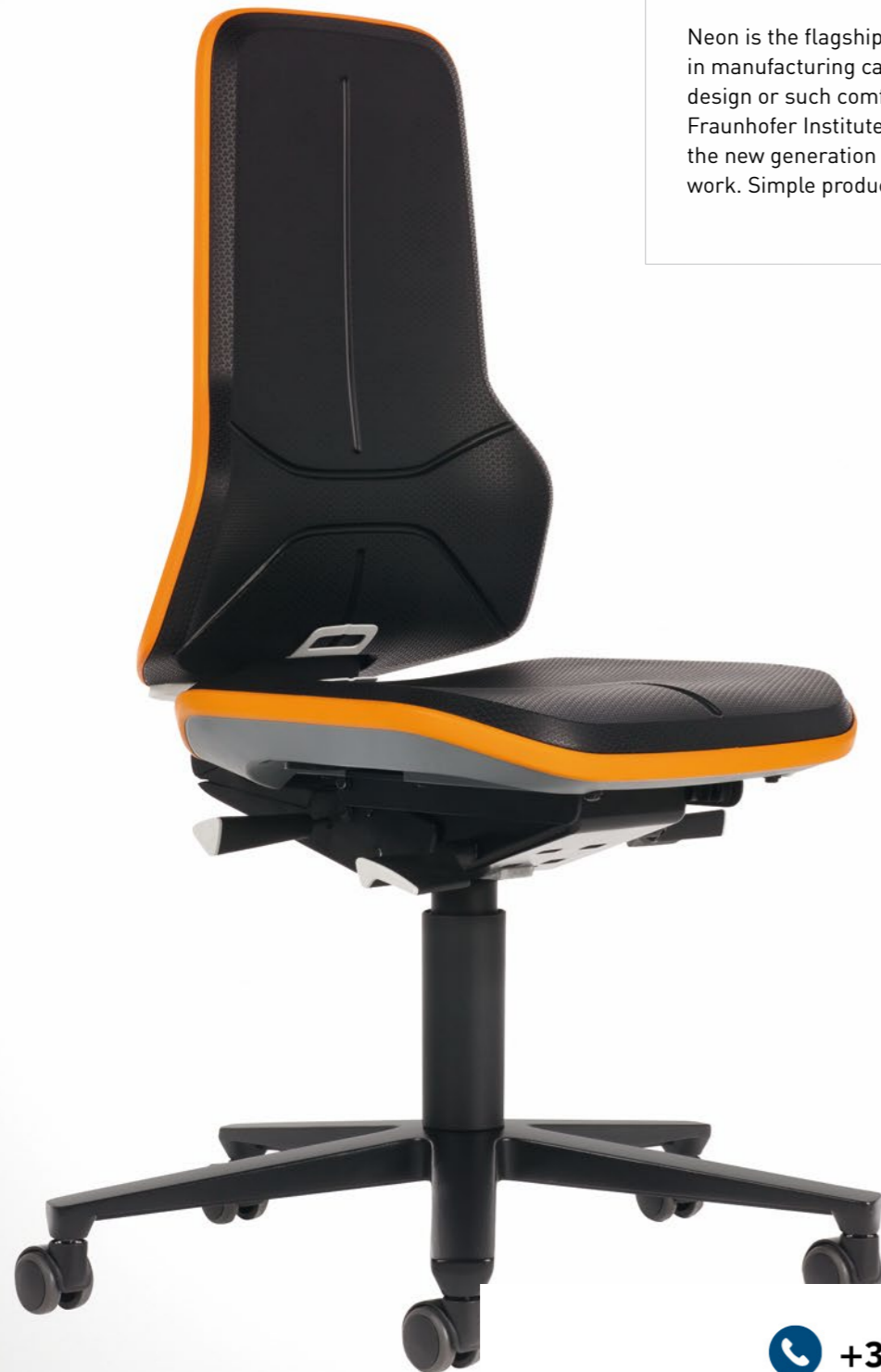

The Neon 1+1 system

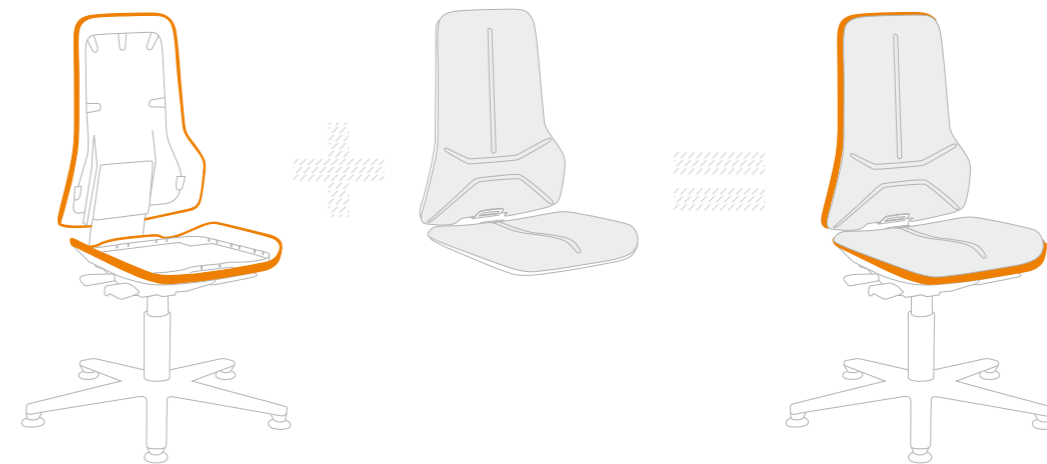

reddot design award
winner 2013



Neon consists of two elements: the chair element with base and mechanism and the upholstery element. This offers many advantages:

- **Sustainability:** When you need new upholstery, you do not need to dispose of the whole chair. You just change the upholstery with a single click.
- **Flexibility:** If Neon is to be used in another work area, it is only the upholstery element that needs to be changed.
- **Economy:** Make a one-off investment in a chair, and then only replace upholstery when necessary. The decision to go for a Neon is a long-term investment.
- **Individuality:** Upholstery determines use: changing upholstery surfaces to suit changing uses.
- **Speed of delivery:** The modular construction means that not every chair has to be individually finished after an order is received. This leads to extremely short delivery times.
- **Changeable upholstery:** Different employees in the same workplace – for instance on multiple shift different upholstery.

+32 (0)9 232 06 78

info@awp.be

Destelbergen



Neon



+32 (0)9 232 06 78

info@awp.be

Destelbergen



Neon

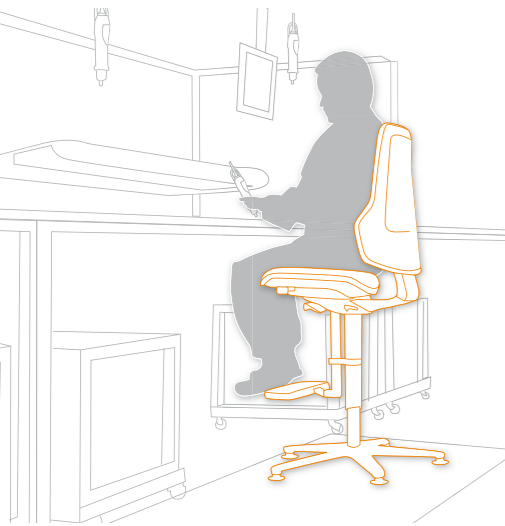

Design and materials

The most striking feature of Neon is its flex strip. It is made of soft plastic and serves to protect the chair and its environment. There is a choice of three colours for the flex strip. The chair itself consists of solid steel with an aluminium base. All the metal parts are black. The tough plastic parts are basalt grey. Neon is available with a choice of castors with load-sensitive brakes for hard floors or with abrasion-resistant glides. In addition, for the high version, there are optional Stop & Go castors available; also a height-adjustable mounting aid that can be folded upwards.

Mechanism (for precise details, see pages 16 – 17)

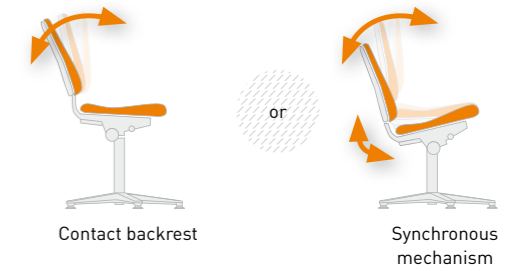

Ergonomic package (for precise details, see pages 16 – 17)

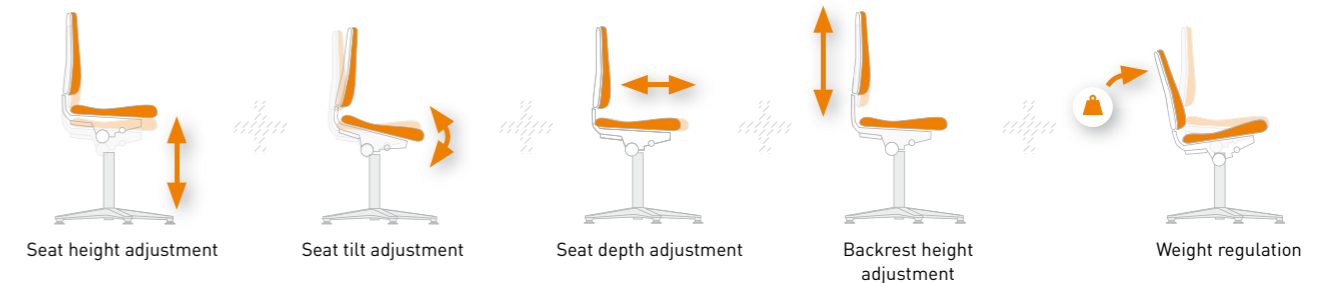

Accessories

(for precise details, see page 149)

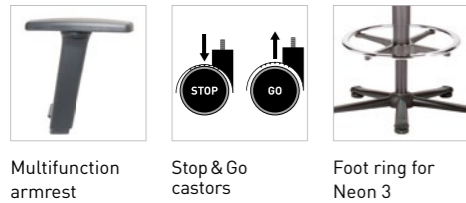

Neon 1 with glides

Seat height adjustment range: 450 to 620 mm.

Design

Permanent contact inc. ergonomic package

Order no.

9560-Flex strip colour



Neon 2 with castors

Seat height adjustment range: 450 to 620 mm.

Design

Permanent contact inc. ergonomic package

Order no.

9563-Flex strip colour



Neon 3 with mounting aid and glides

Seat height adjustment range: 590 to 870 mm.

Design

Permanent contact inc. ergonomic package

ology inc. ergonomic package

Order no.

9561-Flex strip colour

9571-Flex strip colour

Flex strip colour

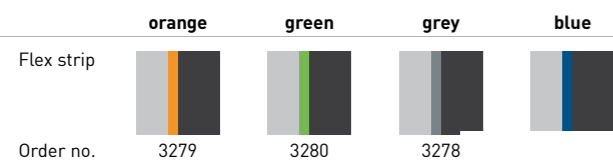

+32 (0)9 232 06 78

info@awp.be

Destelbergen















Neon

Design and materials

Neon's innovative 1+1 system allows you to change the upholstery with a single click, so that it adapts to any particular work environment. With the 1+1 system, you order chair and upholstery elements separately (please note that you can only sit on the chair with an upholstery element). There is an extensive range of upholstery

material available for the most varied uses: there is tough integral foam upholstery, which is able to withstand mechanical damage; easy-care synthetic leather that is soft and washable; robust and breathable fabric upholstery; as well as the world first – "Supertec" – an innovative fabric covering that combines the advantages of fabric and integral foam.

Upholstery finish and colour options

Finish	Black	Blue	Grey
Duotec fabric			
Order no.	6801	6802	6811
Magic synthetic leather			
Order no.	MG01	MG02	MG11
Integral foam			
Order no.	2000	2001	2002
Supertec			
Order no.	SP01	SP02	SP11

„Supertec“ – a world first among cover materials

Neon is not just a trail-blazer in terms of ergonomics, design and comfort. It also sets standards in its choice of materials. Neon is the first workplace chair to make use of the "Supertec" cover material. This consists of a textile substrate covered with micro-studs. This makes Supertec upholstery breathable, soft and comfortable, and at the same time very tough, cut resistant, non slip and easy to clean.

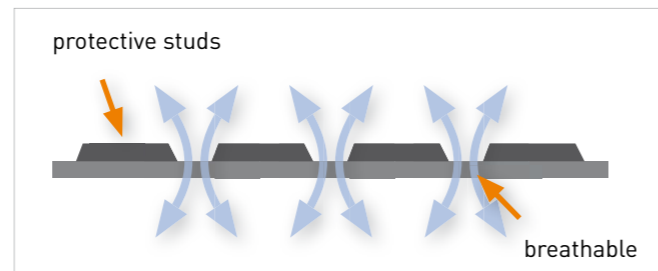

Partly hard, yet overall very soft.



Neon fabric upholstery

breathable, comfortable, soft, hard-wearing

Design	Order no.
Duotec fabric	9588-colour no.



Neon synthetic leather upholstery

washable, low-maintenance, resistant to oil and disinfectants, soft and comfortable

Design	Order no.
Magic synthetic leather	9588-colour no.



Neon integral foam upholstery

extremely tough, durable, washable, capable of withstanding mechanical damage, resistant to flying sparks, resistant to mild acids and alkalines

Design	Order no.



Neon Supertec upholstery

comfortable, soft, breathable, very tough, cut resistant, non slip, easy to clean

Design	Order no.
	9588-colour no.

Sintec



The tried and tested solution for custom seating

Many of our industrial customers swear by Sintec, because it provides users with maximum flexibility and is completely user-friendly. Its superb ergonomic design and individual functions coupled with the wide selection of mechanisms make it the ideal chair for any workplace scenario.

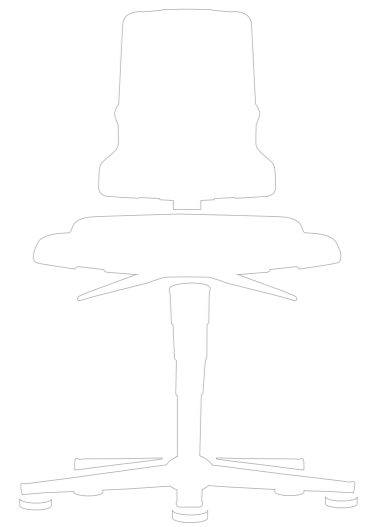

Production

Sintec's replaceable upholstery elements provide maximum flexibility. It is the combination of all these factors that makes Sintec our bestseller. It was precisely with this high standard of economics and functionality in mind that Sintec was developed in conjunction with the Fraunhofer Institute (IAO). The experts were so impressed by the results that they decided to award Sintec the Baden-Württemberg prize for innovation.

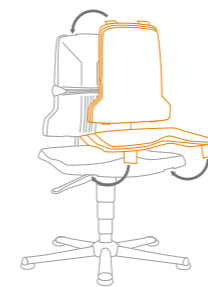

Easily replaceable seat and backrest upholstery

Various seat and backrest upholstery options are available for Sintec, enabling chairs to be perfectly adapted for any working environment. Changing the upholstery couldn't be easier thanks to the quick and convenient hook-on concept. But this does not mean that comfort is left to fall by the wayside: The upholstery provides a real feeling of luxury.



Anatomically designed backrest

The high backrest takes the strain off your spine and muscles. This is achieved by means of its special shape: wide at the bottom and narrow at the top. In this way the backrest provides optimum support for your lumbar region whilst allowing your arms and upper body the space and freedom they need higher up in order to move around.

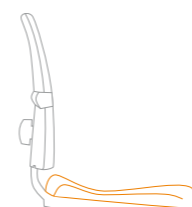

The ergonomic design of the seat increases performance

The anatomically designed seat automatically encourages you to sit correctly. It supports your bottom even when tilted, encourages precise motor function and ensures constant contact with the backrest. The distinctive pelvis support helps keep your pelvis upright and preserves the natural S-shape of your spine. These measures prevent tiredness and im-

+32 (0)9 232 06 78

info@awp.be

Destelbergen



Sintec

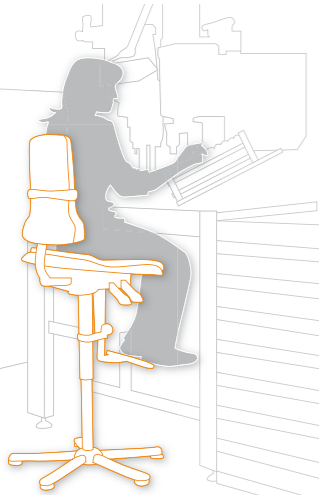

Design and materials

Sintec is equipped with robust plastic seat and backrest shells as standard. Various finish and colour options are available for the high-comfort replaceable upholstery for the seat and backrest (for more information, see pages 34/35). Sintec features a five-legged base frame with flat lines made from sectional steel tubing. The plastic and steel components are painted basalt grey (RAL 7012). Sintec can be supplied with special castors featuring load-sensitive brakes for hard floors or with abrasion-resistant glides as an option.

Mechanisms and functions (for precise details, see pages 16 - 17)

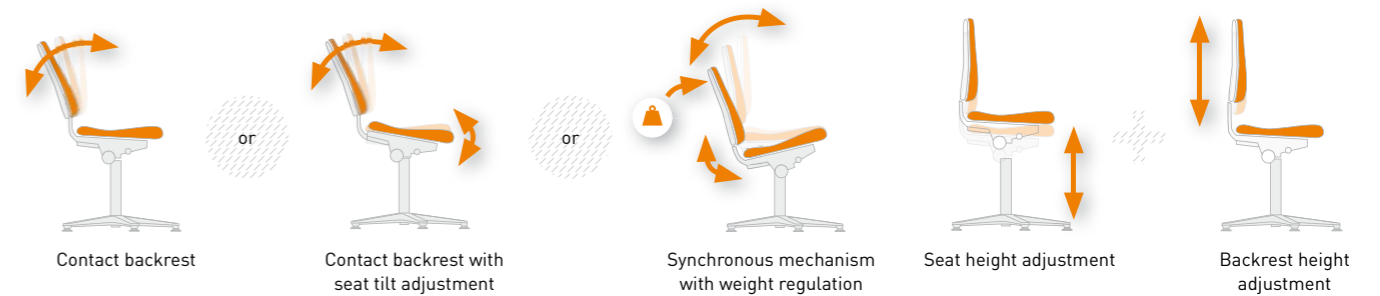

Options



Disc base Polished aluminium base Seat depth adjustment

Accessories (for precise details, see page 149)



Ring-shaped armrest Multifunction armrest Carry handle Swivel lock



Foot ring Stop & Go castors Lap belt Full belt safety harness



Sintec 1 with glides

Seat height adjustment range: 430 to 580 mm.

Design	Order no.
Contact backrest	9800-1000
Contact backrest with tilting seat	9810-1000



Sintec 2 with castors

Seat height adjustment range: 430 to 580 mm.

Design	Order no.
Contact backrest	9803-1000
Contact backrest with tilting seat	9813-1000



Sintec 3 with glides and step

Seat height adjustment range: 580 to 850 mm.

Design	Order no.
Contact backrest	9801-1000
Contact backrest with tilting seat	9811-1000
anism with weight regulation	9821-1000

Sintec

Design and materials

Depending on where they are going to be used, all Sintec workplace chairs can be fitted with fabric, synthetic leather or hard-wearing integral foam upholstery. The upholstery is attached using a simple hook-on system. This innovative, yet straightforward principle means that you can adapt the chair to the individual workplace scenario. All Sintec replaceable upholstery provides a luxurious level of comfort.

Sintec replaceable upholstery

- Quick and easy to attach thanks to the hook-on system
- Can be changed at any time
- Highly economical, as upholstery can simply be swapped
- Improves the workplace's unique appeal and its flexibility
- Increases seat height by 20 mm

Functions



Upholstery with lumbar pad: Provides exceptional support for your lumbar region.

Upholstery finish and colour options

Finish	Black	Blue	Grey	Red
Duotec fabric				
Order no.	6801	6802	6811	6803
Supertec				
Order no.	SP01	SP02	SP11	
Skai synthetic leather				
Order no.	2571	6902	6911	6903
Integral foam				
Order no.	2001			



Sintec integral foam upholstery

Easy-care, washable and robust covering, resistant to mild acids and alkalis and capable of withstanding mechanical influences. Structured surface for optimum climatic comfort.

Design	Order no.
Integral foam upholstery, blue	9865-2001



Sintec fabric upholstery

Soft, breathable upholstery with hard-wearing cover fabric.

Sintec Supertec upholstery

comfortable, soft, breathable, extremely tough, cut-resistant, non-slip, easy to clean

Sintec synthetic leather upholstery

Washable upholstery with Skai covering. Antibacterial, antimicrobial and antifungal.

Design	Order no.
Duotec fabric	9875-Colour no.
Supertec	9875-Colour no.



Sintec fabric upholstery with lumbar pad

Soft, breathable upholstery with hard-wearing cover fabric.

Sintec Supertec upholstery w. lumbar pad

comfortable, soft, breathable, extremely tough, cut-resistant, non-slip, easy to clean

Sintec synthetic leather upholstery with lumbar pad

Washable upholstery with Skai covering.

Design	Order no.
Duotec fabric	9876-Colour no.
Supertec	9876-Colour no.
	9876-Colour no.

Nexxit

Your perfect partner at work

Ergonomically designed, user-friendly and incredibly robust – modern industry places specific demands on the quality of workplace chairs. The Nexxit's unique industrial ergonomics, coupled with a mechanism that allows the user to adjust the

chair easily and intuitively to their individual needs, automatically establish the correct sitting posture. The backrest's range of motion can be preset to one of three different settings, guaranteeing the optimal working range for any task. With impressive comfort and extreme durability, it is ideal for use in industrial environments. This makes the Nexxit your perfect partner for all types of task.

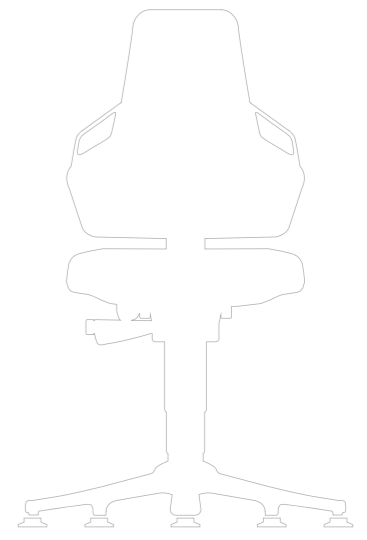

Production



Fraunhofer
IAO

3-level pre-selection

The right working range for every task. In order to meet the different work requirements, the range of motion of the Nexxit's backrest can be adjusted to one of three different settings:

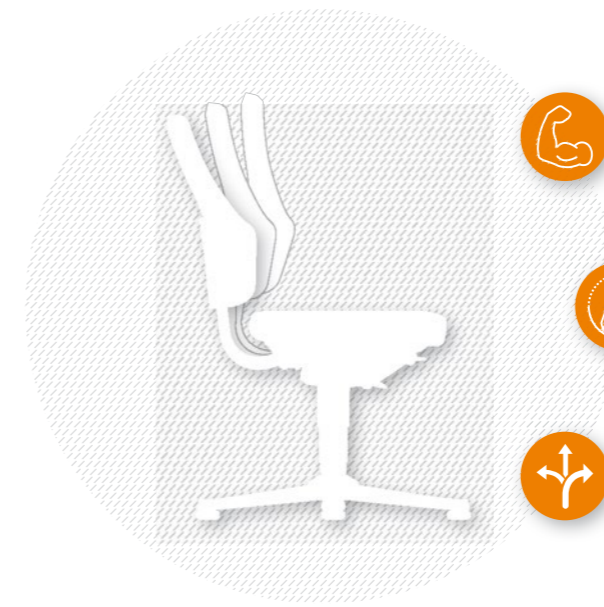

Setting 1 locks the backrest in place, providing optimal support for work that requires a lot of force or effort.



Setting 2 allows for dynamic sitting with a medium range of motion for precision mechanical activities, e.g. activities in which the user is working with their eye close to the workpiece.



Setting 3 offers the full range of motion where ample scope for manoeuvring and reaching is required.

+32 (0)9 232 06 78

info@awp.be

Destelbergen



Nexxit



Production

+32 (0)9 232 06 78

info@awp.be

Destelbergen



Nexxit



Design and materials

Not only is the Nexxit uncomplicated, but its synchronous mechanism with automatic weight adjustment adapts readily to the user's individual needs and performs the essential basic adjustments automatically. Its high-quality materials make the Nexxit exceedingly durable, allowing it to withstand the kinds of conditions typically encountered in industrial environments. For instance, the connecting element between the seating surface and backrest is made from robust steel, as is the sturdy base. The practical, functional handles not only add a characteristic splash of colour – they also make it easy to transport the chair from one place to another.

Ergonomic package (for precise details, see pages 16–17)



Accessories (for precise details, see page 149)

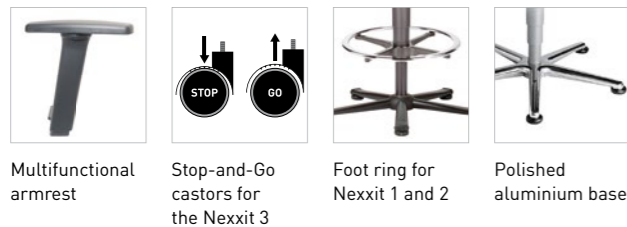

Upholstery cover materials

Cover material	Magic synthetic leather	Integral foam (PU)	Duotec fabric	Supertec
Order No.	MG01	2000	6801	SP01

Handle colours

Colours	Blue	Grey	Orange	Green	No handles
Order No.	3277	3278	3279	3280	3001



Nexxit 1 with glides

Seat height adjustment range: 450 to 600 mm.

Design	Order No.
Magic synthetic leather	9030-MG01
Integral foam (PU)	9030-2000
Duotec fabric	9030-6801



Nexxit 2 with castors

Seat height adjustment range: 450 to 600 mm.

Design	Order No.
Magic synthetic leather	9033-MG01
Integral foam (PU)	9033-2000
Duotec fabric	9033-6801



Nexxit 3 with glides and foot ring

Seat height adjustment range: 570 to 820 mm.

Design	Order No.
Magic synthetic leather	9031-MG01
Integral foam (PU)	9031-2000
Duotec fabric	9031-6801
	9031-SP01

All-In-One Highline / Trend

The all-inclusive seating solution

The Bimos All-In-One closes the gap between office chair and workplace chair. This versatile new seating solution offers all the ergonomic features you would expect in a good office chair. The concept of all-inclusive ergonomics ensures that All-in-One suits every single person and every single workplace situation, without having to make any compromise at all.

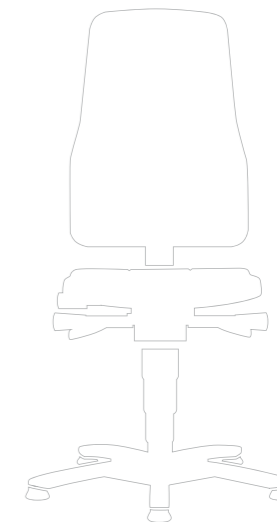

Production

Thanks to its solid construction and tough materials, All-In-One fulfils the demands of a great many workplaces in industry, healthcare, research and development.

The All-In-One has been deliberately designed as a versatile all-rounder rather than a specialist. So it is perfect for use in places wherever people want to sit comfortably in demanding working environments. All-in-One is a chair with two heads: it is available in two design variants – Highline and Trend – to fit in with various different visual concepts.



A chair that can do everything

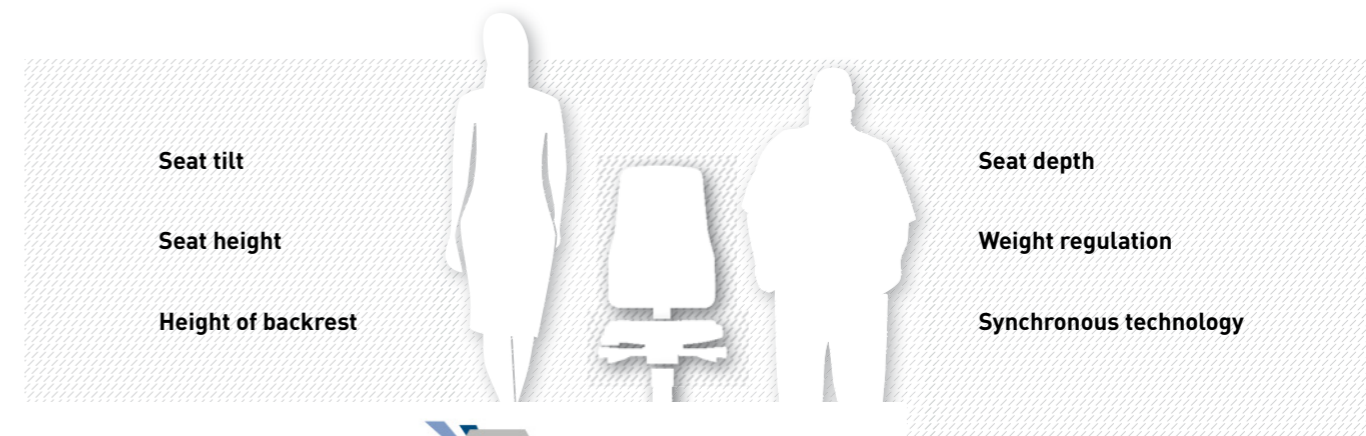
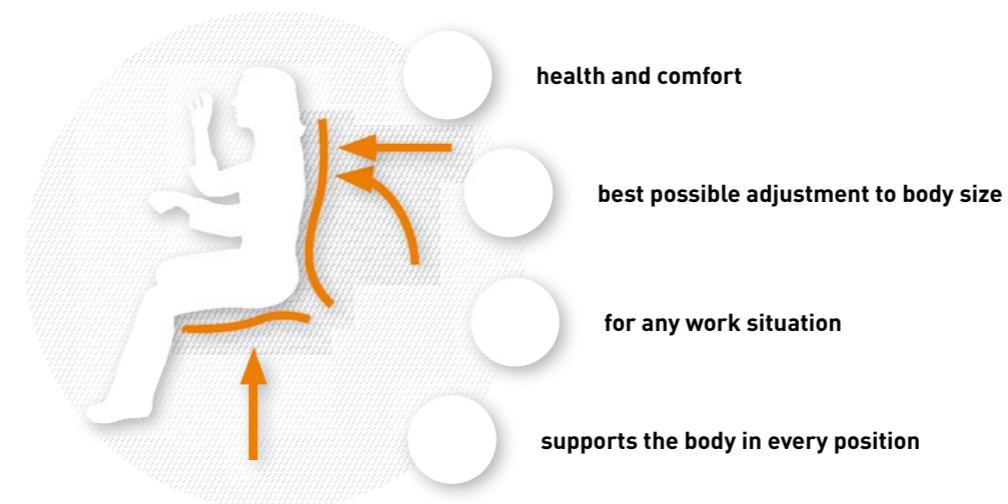

+32 (0)9 232 06 78

info@awp.be

Destelbergen



All-In-One Highline



Design and materials

The All-In-One Highline is the design concept that has an especially high back. The All-In-One Highline has a stable tubular steel base with flat lines. All the steel parts are painted black. The plastic parts are black too, and extremely tough. The high version of the All-In-One Highline features a chromed foot ring that is height-adjustable, and can be used as foot support and as a mounting aid. The All-in-One Highline can be fitted either with castors with load-sensitive brakes for hard floors, or with abrasion-resistant glides. On request, the high version can also be supplied with Stop & Go castors.

Mechanisms and functions (for precise details, see pages 16 – 17)



Accessories (for precise details, see page 149)



Armrests are height-, depth- and width-adjustable and can be swivelled

Foot ring

Stop & Go castors

Finish and colour options for seat and backrest

Finish	Black	Blue	Grey	Red
Duotec fabric				
Order no.	6801	6802	6811	6803
Skai synthetic leather				
Order no.	2571	6902	6911	6903
Integral foam				
Order no.	2000			



All-In-One Highline 1 with glides

Seat height adjustment range: 450 to 600 mm.

Design	Order no.
Duotec fabric	9640-Colour no.
Skai synthetic leather	9640-Colour no.



All-In-One Highline 2 with castors

Seat height adjustment range: 450 to 600 mm.

Design	Order no.
Duotec fabric	9643-Colour no.
Skai synthetic leather	9643-Colour no.



All-In-One Highline 3 with glides and foot ring

Seat height adjustment range: 570 to 830 mm.

Design	Order no.
Duotec fabric	9641-Colour no.
Skai synthetic leather	9641-Colour no.
	9641-2000

All-In-One Trend



Design and materials

The All-In-One Trend is the All-In-One swivel workchair with a backrest of medium height. Its base can be supplied in black plastic or in a black painted tubular steel version. All the other steel parts are also painted black. And the tough plastic parts are finished in black. The high version of the All-In-One Trend features a chromed foot ring that is height-adjustable, and can be used as foot support and as a mounting aid. The All-in-One Trend can be fitted either with castors with load-sensitive brakes for hard floors, or with abrasion-resistant glides. On request, the high version can also be supplied with Stop & Go castors.

Mechanisms and functions (for precise details, see pages 16 – 17)



Accessories (for precise details, see page 149)



Armrests are height, depth and width-adjustable and can be swivelled

Foot ring

Steel base

Stop & Go castors

Finish and colour options for seat and backrest

Finish	Black	Blue	Grey	Red
Duotec fabric				
Order no.	6801	6802	6811	6803
Skai synthetic leather				
Order no.	2571	6902	6911	6903
Integral foam				
Order no.	2000			



All-In-One Trend 1 with glides

Seat height adjustment range: 450 to 600 mm.

Design	Order no.
Duotec fabric	9630-Colour no.
Skai synthetic leather	9630-Colour no.



All-In-One Trend 2 with castors

Seat height adjustment range: 450 to 600 mm.

Design	Order no.
Duotec fabric	9633-Colour no.
Skai synthetic leather	9633-Colour no.



All-In-One Trend 3 with glides and foot ring

Seat height adjustment range: 570 to 830 mm.

Design	Order no.
Duotec fabric	9631-Colour no.
Skai synthetic leather	9631-Colour no.
	9631-2000

Isitec

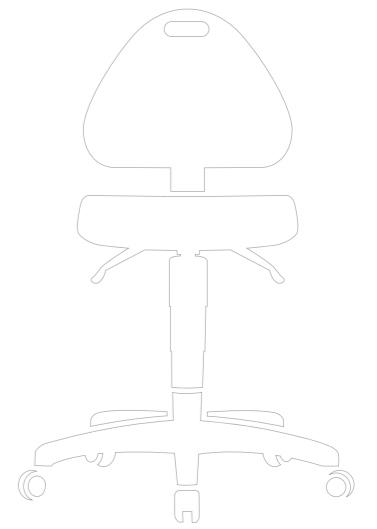

Production

The practical solution for everyday use

There are no airs and graces with Isitec whether faced with swarf, oil or shavings, Isitec will show you what a good industrial chair is capable of. The hard-wearing SoftTouch integral foam provides amazing softness and is a pleasure to sit on. Furthermore, Isitec is easy to clean, and is resistant to disinfectants.

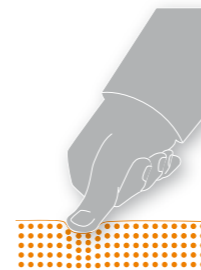

SoftTouch integral foam

SoftTouch integral foam, which is still fresh from the drawing board, provides the ultimate in softness, and is washable and resistant to external influences.

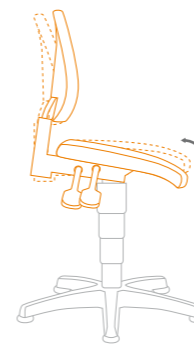

Easily adjustable

Isitec has all the essential qualities of a good workplace chair. All the adjustment functions allow for quick and easy operation via levers while the user is sitting down. The fact that the functions are labelled makes finding the right lever child's play. The continuously variable tilt adjustment function, which can be used to tilt the seat forwards by up to 8° ensures a minimum seat angle of 90° even when leaning forward into the work.

+32 (0)9 232 06 78

info@awp.be

Destelbergen



Isitec



Design and materials

Isitec features a sturdy, five-legged base frame with flat lines made from plastic. All Isitec models are supplied with a black frame. The chrome-plated foot ring has a particularly wide tread and is height-adjustable. Isitec can be supplied with special castors featuring load-sensitive brakes for hard floors (Isitec 2) or with abrasion-resistant glides (Isitec 1 and Isitec 3) as an option.

Mechanisms and functions (for precise details, see pages 16 – 17)

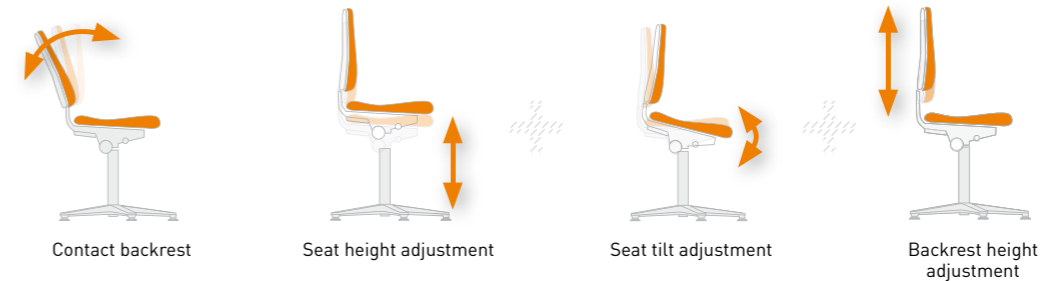

Options



Steel 5 star base

Accessories (for precise details, see page 149)



Ring-shaped armrest



Multifunction armrest



Foot ring

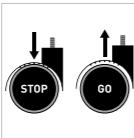

Stop & Go castors

Upholstery finish and colour options

Finish **Black**

Integral foam



Order no.

2000



Isitec 1 with glides

Seat height adjustment range: 430 to 600 mm.

Design

Order no.



Isitec 2 with castors

Seat height adjustment range: 430 to 600 mm.

Design

Order no.



Isitec 3 with glides and foot ring

Seat height adjustment range: 580 to 850 mm.

Design

Order no.

k

9613-2000

Unitec



The low-cost solution for solid performance

Unitec is our low-cost entry model for healthy sitting in a production context. The contact backrest, which is supplied as standard, provides support when working sitting down.

The generously proportioned seat and backrest provide additional support. There is a choice of various coverings to ensure that Unitec will fit in visually with practically any working environment. Consequently, Unitec is a good solid chair for almost any application.

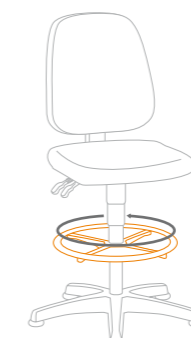

Foot ring

The chrome-plated foot ring provides a firm foothold thanks to its wide tread and can be quickly and easily adjusted in terms of its height.

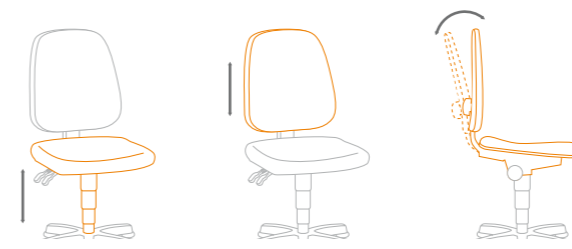

Standard functions for first-time buyers

- Seat height adjustment
- Backrest height adjustment
- Contact backrest

+32 (0)9 232 06 78

info@awp.be

Destelbergen



Unitec

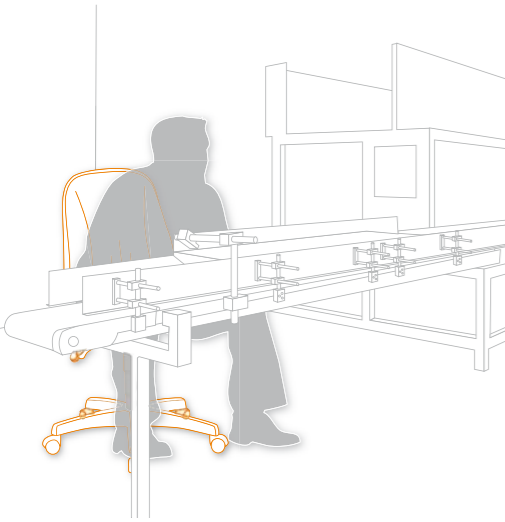

Design and materials

Unitec features a sturdy, five-legged base frame with flat lines made from plastic. All Unitec models are supplied with a black base frame. The chair can be supplied with special castors featuring load-sensitive brakes for hard floors (Unitec 2) or with abrasion-resistant glides (Unitec 1 and Unitec 3) as an option. The Unitec seat and backrest are very generously proportioned in the case of the fabric and synthetic leather versions.

Mechanisms and functions (for precise details, see pages 16 – 17)



Accessories (for precise details, see page 149)



Multifunction armrest (not available with wood version)
 Ring-shaped armrest
 Foot ring
 Stop & Go castors

Upholstery finish and colour options

Finish	Black	Blue	Natural
Laminated beech			
Order no.			3000
Fabric Citadel			
Order no.	CI01	CI02	
Synthetic leather			
Order no.	0551	0562	
Integral foam			
Order no.	2000		



Unitec 1 with glides

Seat height adjustment range: 440 to 620 mm.

Design	Order no.
Laminated beech	9650-3000
Fabric	9650-Colour no.
Synthetic leather	9650-Colour no.



Unitec 2 with castors

Seat height adjustment range: 440 to 620 mm.

Design	Order no.
Laminated beech	9653-3000
Fabric	9653-Colour no.
Synthetic leather	9653-Colour no.



Unitec 3 with glides and step

Seat height adjustment range: 580 to 850 mm.

Design	Order no.
Laminated beech	9651-3000
Fabric	9651-Colour no.
Synthetic leather	9651-Colour no.
	9651-2000

Stools

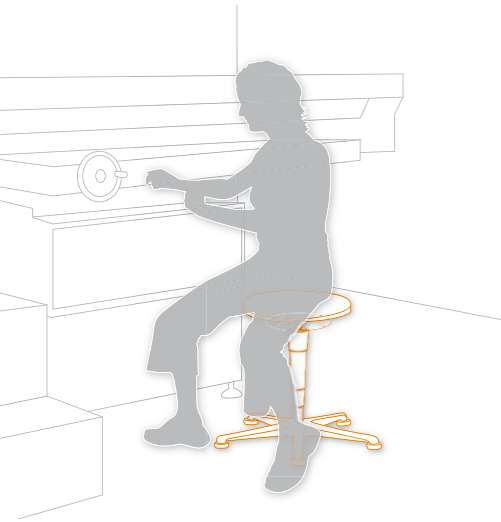

Industrious assistants

With their extra-large 40cm diameter seats, these hard-wearing stools provide optimum support in industrial and workshop applications. The sturdy steel 5 star base and upholstery edge protector that runs all the way round guarantee a long lifespan. The practical pneumatic spring system with easy ring control allows for comfortable seat height adjustment.

Functions (for precise details, see pages 16 – 17)

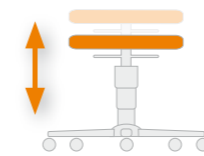

Seat height adjustment based on pneumatic spring system with easy ring control

Options



Polished aluminium
5 star base

Finish and colour options for seat

Finish	Black	Blue	Grey	Red	Natural
Duotec fabric					
Order no.	6801	6802	6811	6803	
Skai synthetic leather					
Order no.	2571	6902	6911	6903	
Integral foam					
Order no.	2000				
Laminated beech					
Order no.					



Stool 1 with glides

Seat height adjustment range: 460 to 630 mm.

Design	Order no.
Laminated beech	9467-3000
Duotec fabric	9467-Colour no.
Skai synthetic leather	9467-Colour no.



Stool 2 with castors

Seat height adjustment range: 460 to 630 mm.

Design	Order no.
Laminated beech	9468-3000
Duotec fabric	9468-Colour no.
Skai synthetic leather	9468-Colour no.



Stool 3 with glides and foot ring

Seat height adjustment range: 570 to 850 mm.

Design	Order no.
Laminated beech	9469-3000
Duotec fabric	9469-Colour no.
Skai synthetic leather	9469-Colour no.
k	9469-2000

Footrests

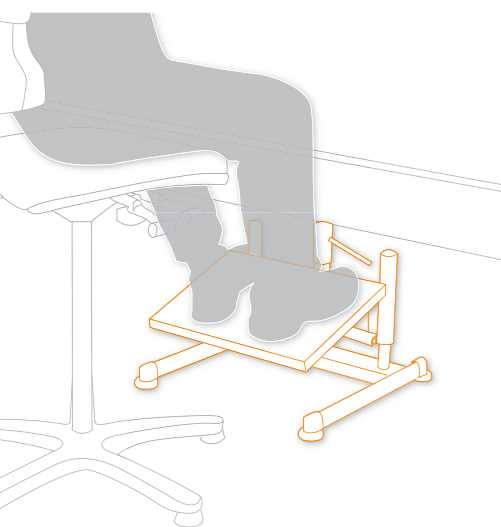

Support in your everyday work

In the case of elevated seating positions, footrests can provide the necessary support for your legs. They can be used to ensure exactly the right angle between your thigh and upper body. That is why the EEC directive governing the minimum health and safety requirements for the workplace specifies the following: "When seated, the employee's feet must be in contact with the floor or a footrest". Bimos industrial footrests are really easy to adjust for the individual concerned, enable the user to adopt the correct posture and thereby ensure good thigh circulation. The non-slip rubber tread provides a firm grip even when the work is physically demanding.

Model 9455 functions

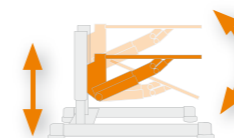

Pedal buttons enable convenient footrest adjustment while seated

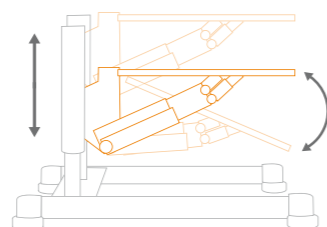

Perfect adaptability

All Bimos footrests feature continuously variable height and tilt angle adjustment. This means that the footrests can be perfectly adapted to any workplace situation. In the case of Model 9455, this is achieved by means of a pneumatic spring, making your footrest as convenient and easy to adjust as the familiar modern workplace chair.



Industrial footrest with pneumatic spring

Non-slip rubber tread.
Height adjustment range: 100 to 340 mm.
Tilt adjustment range: 8° to 25°.
Tread dimensions: 440 x 340 mm.

Design

Order no.



Industrial footrest with clamp lever

Non-slip rubber tread.
Height adjustment range: 65 to 410 mm.
Tilt adjustment range: 8° to 25°.
Tread dimensions: 440 x 340 mm.

Design

Order no.

9450

Sintec 160



The workchair for people up to 160 kg

We have made it our mission to provide the right workplace chair for absolutely everybody. And that applies to also to very heavy people. The Sintec 160 is the ideal solution for these people. Sintec 160 gives heavy people all the same positive seating features that are available in the standard version of Sintec. All the components are specially designed for particularly heavy loads. Its broad-based construction does not constrain Sintec 160 at all, and gives heavy people plenty of room to move around. Sintec 160 has a polished aluminium base. The width of the optional ring armrests is adjustable. Sintec 160 has the same replaceable upholstery system as Sintec.

Mechanisms and functions (for precise details, see pages 16 – 17)



Accessories (for precise details, see page 149)



Ring-shaped armrest

Upholstery finish and colour options

Finish	Black	Blue	Grey	Red
Genius fabric				
Order no.	GE01	GE02	GE11	
Skai synthetic leather				
Order no.	2571	6902	6911	6903
Integral foam				
Order no.	2000			

- extra thick upholstery
- extra large stable base Ø 740 mm
- robust and safe construction
- outstandingly comfortable sitting
- generous space between armrests = 570 mm

Armrest optional



Sintec 160 including glides and castors

Seat height adjustment range: 490 to 640 mm.
(with glides 450 to 600 mm)

Design	Order no.
Genius fabric	9816-Colour no.
Skai synthetic leather	9816-Colour no.
	9816-2000

ESD area

**“In the ESD workplace
it comes down
to relieving tension.”**

 +32 (0)9 232 06 78

 info@awp.be

 Destelbergen



ESD area

Reliable electrostatic discharge protection for electronic workstations

ESD (Electro Static Discharge) refers to the electrostatic discharge of charged objects or people. Electrostatic discharge can result in damage to microelectronics components. This is because of the minute scale involved which means that the energy from a static discharge has the same impact on a semiconductor as a lightning strike would on a tree. ESD chairs play a crucial role when it comes to ensuring reliable ESD protective measures for electronic workstations.

ESD protection is regulated by European standard EN 61340, which is designed to help users select appropriate protective measures. It stipulates the following in respect of workplace chairs: "The resistance to the point of contact with the floor of any parts of the seat that could come into contact with the user's body during standard use must be $<10^9 \Omega$." (Extract from standard EN 61340-5-1)

Discharge resistance	Acc. to EN 61340-5-1	Bimos ESD chairs
Workplace chair	$<10^9 \Omega$	$10^6 \Omega$
Surface resistance	Acc. to EN 61340-5-1	Bimos ESD chairs
Workplace chair	-	$10^6 \Omega$

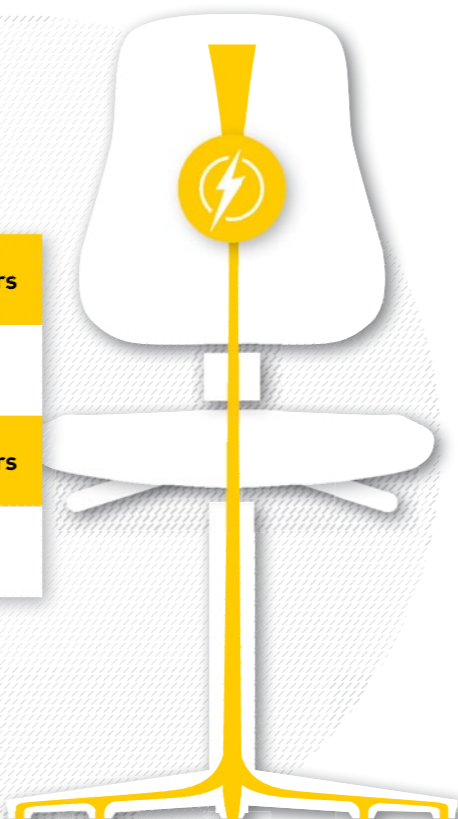

All-round safety: the unique Bimos ESD protection features

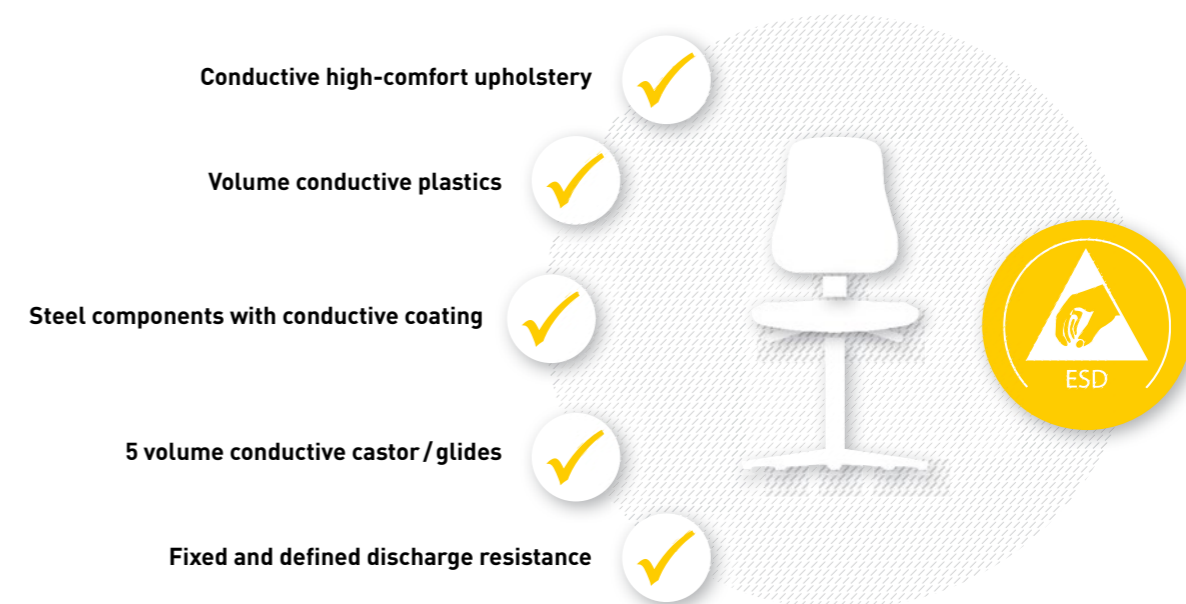

Consistently exceeding the standard

Bimos ESD chairs meet the requirements of standard EN 61340-5-1 as far as their use in EPAs (ESD Protected Areas) is concerned. However, the demands that actually apply in practice are often more stringent even than this. This is because the increasing miniaturisation of electronics components is making them more susceptible to the problem of electrostatic discharge. The most effective way of dealing with this issue is either to prevent charges from occurring in the first place or to ensure that any undesirable charges are safely discharged.

Thanks to the optimum choice of materials and connection technology used, Bimos chairs reliably prevent the build-up of electrostatic charges. In addition, the chairs are designed to direct any charges that the user may be carrying safely down to the conductive base as soon as he or she sits down. Thus, Bimos ESD chairs offer a fully integrated system of protection.

ESD Neon

ESD

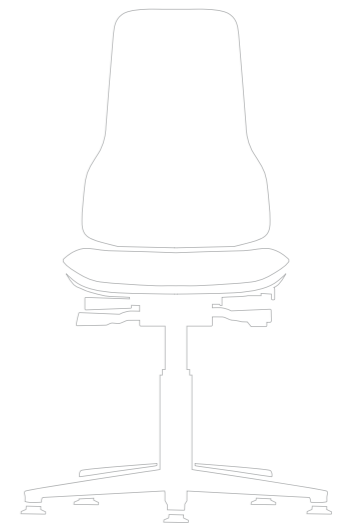

New generation workchairs

Neon is probably the best workplace chair for ESD areas. Like all Bimos ESD chairs, it far exceeds the requirements of the ESD standard EN 61340-5-1. In addition to its outstanding key technical features, the ESD Neon has one characteristic that until now has not been found in the ESD working environment: a focus on the human being. As the most ergonomic and most

comfortable ESD chair available, Neon forms a bridge between uncompromising technical demands and enjoyment in sitting. The workplace is an indicator of the value a company places on its employees. A chair that focuses on the needs of people helps to orientate and motivate, it raises the quality and productivity of work. ESD workplaces are always to be found in high-tech companies. This contemporary aspect is also reflected in Neon's design. For the first time with the ESD Neon, a chair is at last available that is really in tune with the work that is carried out on it. ESD Neon is the new generation workplace chair for the new generation of work.



reddot design award
winner 2013



The characteristics of the Bimos ESD protection system



+32 (0)9 232 06 78

info@awp.be

Destelbergen



ESD Neon

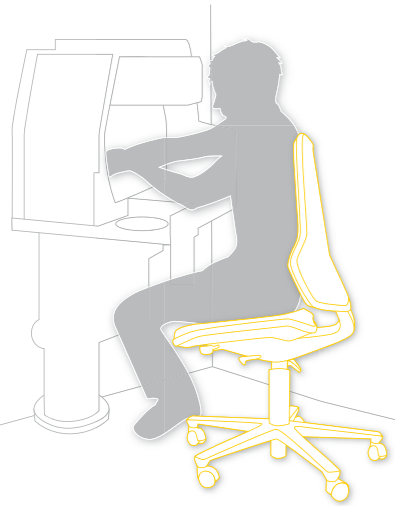

Design and materials

All the plastic and metal parts in ESD Neon are black. The reason for this is because they are conductive, as is every component in the Neon. Plastic too is coated with carbon particles to make it conductive. The most striking feature of ESD Neon is its flex strip. It is made of soft plastic and protects the chair and its environment. There is a choice of three colours for the flex strip. The chair itself consists of solid steel with an aluminium base. Neon is available with a choice of castors with load-sensitive brakes for hard floors, or with abrasion-resistant glides. In addition, for the high version optional Stop & Go castors are available. All glides and castors are volume conductive.

Mechanisms (for precise details, see pages 16 – 17)

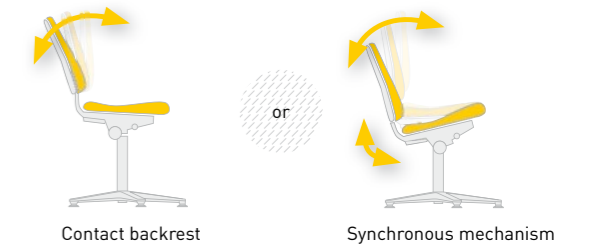

Ergonomics package (for precise details, see pages 16 – 17)

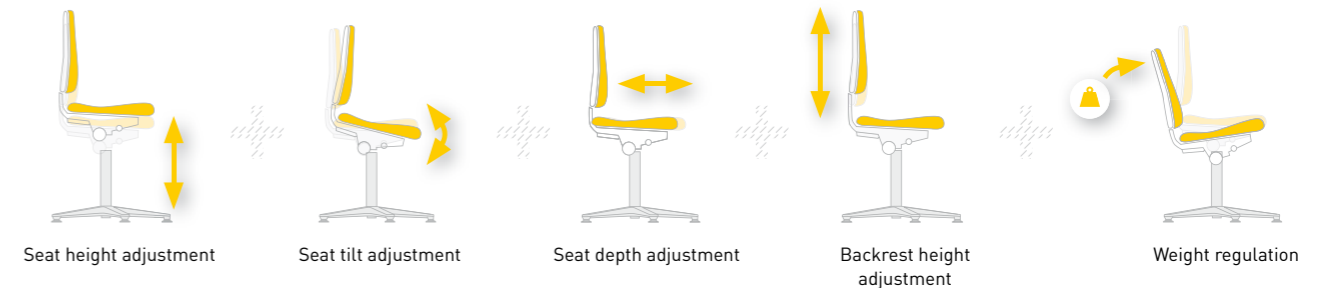

Options



Polished aluminium
5 star base

Accessories (for precise details, see page 149)



Multifunction
ESD armrest

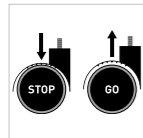

ESD Stop & Go
castors

Flex strip colour

	Orange	Green	Grey	Blue
Flex strip				
Order no.	3279	3280	3278	



ESD Neon 1 with glides

Seat height adjustment range: 450 to 620 mm.

Design

Permanent contact inc. ergonomics package

Order no.

9560E-Flex
strip colour



ESD Neon 2 with castors

Seat height adjustment range: 450 to 620 mm.

Design

Permanent contact inc. ergonomics package

Order no.

9563E-Flex
strip colour



ESD Neon 3 w. mounting aid and glides

Seat height adjustment range: 590 to 870 mm.

Design

Permanent contact inc. ergonomics package

Order no.

9561E-Flex
strip colour

ology inc. ergonomics package

9571E-Flex
strip colour

+32 (0)9 232 06 78

info@awp.be

Destelbergen









ESD Neon

Design and materials

The ESD Neon always comprises two basic elements: The chair itself and the upholstery set. This innovative 1+1 system allows the ESD Neon's upholstery to be tailored to the working environment in which it is to be used with just one click (please note: The chair cannot be used without the upholstery element). In spite of the tough technical demands that an environment subject to ESD places on the

material properties, the ESD Neon is available with a choice of four different upholstery variants: Hard-wearing, comfortable Supertec upholstery, integral upholstery, which is also able to withstand extreme mechanical stresses, easy-care imitation leather, which is soft and can be wiped clean, and durable, breathable fabric upholstery.

Upholstery finish and colour options

Finish	Black	Blue	Grey
Duotec ESD fabric			
Order no.	9801	9802	9811
Magic synthetic leather			
Order no.	MG01		
Integral foam			
Order no.	2000		
Supertec ESD			
Order no.	CP01		



ESD Neon fabric upholstery

breathable, comfortable, soft, hard-wearing

Design	Order no.
Duotec ESD fabric	9588E-Colour no.



ESD Neon synthetic leather upholstery

washable, easy-care, soft and comfortable

Design	Order no.
Magic synthetic leather	9588E-MG01



ESD Neon integral foam upholstery

extremely robust, durable, washable, able to withstand mechanical damage, resistant to mild acids and alkalis

Design	Order no.



ESD Neon Supertec upholstery

Comfortable, soft, breathable, incredibly hard-wearing, cut-resistant, non-slip and easy to clean

Design	Order No.
	9588E-CP01

ESD Sintec

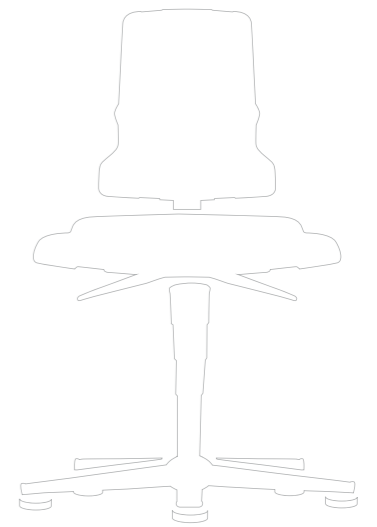

ESD

The tried and tested solution for custom seating

ESD Sintec is characterised by its excellent ESD protection properties for maximum reliability: It is manufactured using volume conductive materials and features conductive surfaces. Its superb ergonomic design and individual functions

make it the ideal chair for any workplace scenario. ESD Sintec combines perfect support for your workplace tasks with a high level of comfort. The backrest is tapered towards the top, thereby providing more space for moving your arms around. ESD Sintec's replaceable upholstery elements provide maximum flexibility. It is the combination of all these factors that makes ESD Sintec our best selling ESD chair.



The characteristics of the Bimos ESD protection system

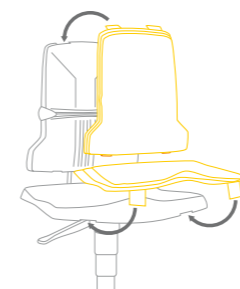
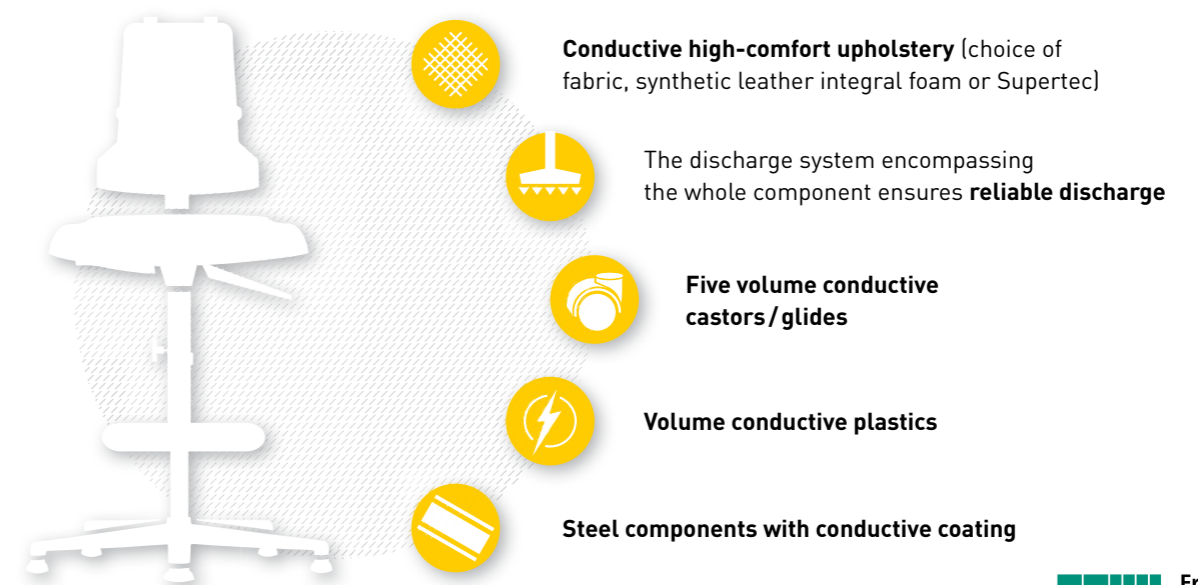

Easily replaceable seat and backrest upholstery

Various conductive seat and backrest upholstery options are available for ESD Sintec, enabling chairs to be perfectly adapted for any working environment. Changing the upholstery couldn't be easier thanks to the quick and convenient hook-on concept.

+32 (0)9 232 06 78

info@awp.be

Destelbergen



ESD Sintec



Design and materials

ESD Sintec is equipped with seat and backrest shells made from volume conductive plastic. The conductive quick-change upholstery means that you can tailor this ESD chair to create the look you want. The chair features a sturdy five-legged base frame with flat lines, which is made from sectional steel tubing. This offers great stability as well as highly reliable electrostatic discharge. All ESD Sintec models are supplied with a black frame.

Mechanisms and functions (for precise details, see pages 16 – 17)

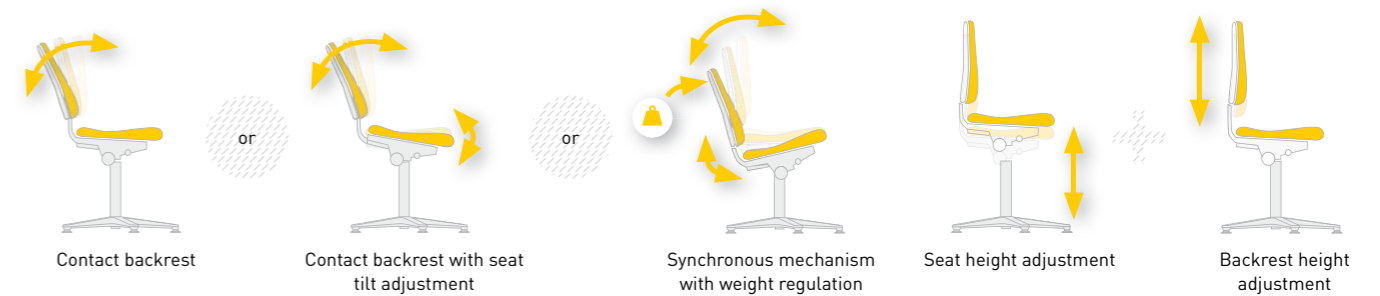

Options



Polished aluminium 5 star base

Seat depth adjustment



Ring-shaped armrest

ESD multifunction armrest

Foot ring

Carry handle

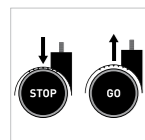

ESD Stop & Go castors



ESD Sintec 1 with glides

Seat height adjustment range: 430 to 580 mm.

Design	Order no.
Contact backrest	9800E-1100
Contact backrest with tilting seat	9810E-1100



ESD Sintec 2 with castors

Seat height adjustment range: 430 to 580 mm.

Design	Order no.
Contact backrest	9803E-1100
Contact backrest with tilting seat	9813E-1100



ESD Sintec 3 with glides and step

Seat height adjustment range: 580 to 850 mm.

Design	Order no.
Contact backrest	9801E-1100
Contact backrest with tilting seat	9811E-1100
anism with weight regulation	9821E-1100

+32 (0)9 232 06 78

info@awp.be

Destelbergen



ESD Sintec

Design and materials

All ESD Sintec workplace chairs can be furnished with fabric, imitation leather or integral foam (PU) upholstery – or alternatively, with breathable, hard-wearing Supertec upholstery. The upholstery can be swapped over by simply hooking the new one in place. This innovative yet strikingly simple principle allows the workplace chair to be adapted for different workplace situations. All ESD Sintec interchangeable upholstery is both exceptionally comfortable to sit on and boasts excellent ESD properties.

ESD Sintec replaceable upholstery

- Conductive
- Quick and easy to attach thanks to the hook-on system
- Can be changed at any time
- Improves the workplace's unique appeal and its flexibility
- Increases seat height by 20 mm

Functions



Upholstery with lumbar pad: Provides exceptional support for your lumbar region.

Upholstery finish and colour options

Finish	Black	Blue	Grey	Red
Duotec ESD fabric				
Order no.	9801	9802	9811	9803
Skai ESD synthetic leather				
Order no.	2571			
ESD integral foam				
Order no.	2000			
ESD Supertec				
Order no.	CP01			



ESD Sintec integral foam upholstery

Easy-care, washable and robust covering, resistant to mild acids and alkalis and capable of withstanding mechanical influences. Structured surface for optimum climatic comfort.

Design

Order no.



ESD Sintec fabric upholstery

Soft, breathable upholstery consisting of hard-wearing cover fabric.

ESD Sintec Supertec upholstery

Comfortable, soft, breathable, incredibly hard-wearing, cut-resistant, non-slip and easy to clean

ESD Sintec synthetic leather upholstery

Non-slip and non-tear padding made from faux leather.

Design

Order no.

Duotec ESD fabric

9875E-Colour no.

ESD Supertec

9875E-CP01



ESD Sintec fabric upholst. with lumb. pad

Soft, breathable upholstery consisting of hard-wearing cover fabric.

ESD Sintec Supertec upholst. with lumb. pad

Comfortable, soft, breathable, incredibly hard-wearing, cut-resistant, non-slip and easy to clean

ESD Sintec synth. leath. upholst. with lumb. pad

Non-slip and non-tear padding made from faux leather.

Design

Order no.

Duotec ESD fabric

9876E-Colour no.

ESD Supertec

9876E-CP01

leather, black

9876E-2571

ESD Nexxit

Your perfect partner when working in ESD areas

Its synchronous mechanism with automatic weight adjustment ensures that the ESD version of the Nexxit provides ergonomic support and is easy and intuitive to use, even in workplaces that require reliable protection against electrostatic discharge.

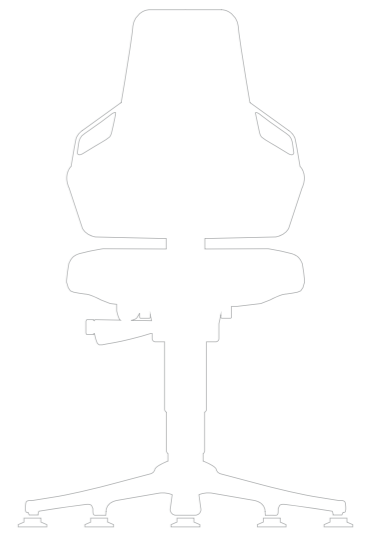

The backrest has three different settings, which allow you to choose the range of motion that is best suited to the task at hand. This makes the Nexxit the perfect partner for all users and all types of task – even in ESD areas.



3-level pre-selection

The right working range for every task. In order to meet the different work requirements, the range of motion of the Nexxit's backrest can be adjusted to one of three different settings.



Bimos ESD-protection features

-  **Conductive comfort upholstery** (choose from fabric, imitation leather, integral foam (PU) or Supertec)
-  Whole-product dissipation achieved by interconnecting all the components ensures that **static electricity is reliably discharged**
-  **Five volume-conductive castors or glides**
-  **Volume-conductive plastics and handles**
-  **Steel parts with a conductive coating**

+32 (0)9 232 06 78

info@awp.be

Destelbergen



ESD Nexxit

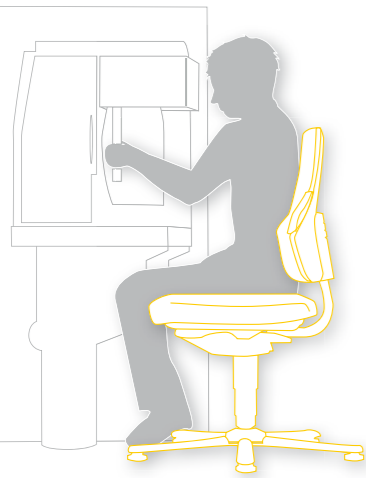

Design and materials

The ESD Nexxit automatically establishes the perfect sitting conditions, whilst also meeting the extraordinarily tough demands placed on products to be used in workplaces in which static electricity must be dissipated. Upholstery, steel and plastic parts, castors and glides designed for use in ESD areas coupled with whole-product dissipation, achieved by interconnecting all the components, guarantee reliable protection against electrostatic charge. The Nexxit's practical, functional ESD handles are conductive and are available in black.

Ergonomic package (for a detailed description, see p. 16-17)



Accessories (for a detailed description, see p. 149)

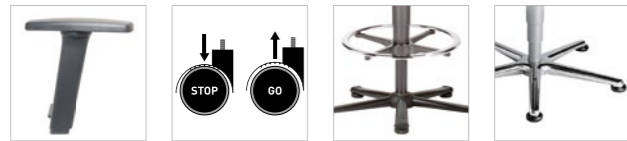

Multifunctional ESD armrests | Stop-and-Go ESD castors for the Nexxit 3 | Foot ring for Nexxit 1 and 2 | Polished aluminium base

Upholstery cover materials

Cover material	Magic synthetic leather	Integral foam (PU)	Duotec fabric	Supertec
Order No.	MG01	2000	9801	CP01

Handle colours

Colours	Black	No handles
Order No.	3218	3001



ESD Nexxit 1 with glides

Seat height adjustment range: 450 to 600 mm.

Design	Order No.
ESD Magic synthetic leather	9030E-MG01
ESD integral foam (PU)	9030E-2000
ESD Duotec fabric	9030E-9801



ESD Nexxit 2 with castors

Seat height adjustment range: 450 to 600 mm.

Design	Order No.
ESD Magic synthetic leather	9033E-MG01
ESD integral foam (PU)	9033E-2000
ESD Duotec fabric	9033E-9801



ESD Nexxit 3 with glides and foot ring

Seat height adjustment range: 570 to 820 mm.

Design	Order No.
ESD Magic synthetic leather	9031E-MG01
ESD integral foam (PU)	9031E-2000
ESD Duotec fabric	9031E-9801
	9031E-CP01

ESD Basic

The tried-and-tested all-rounder for use in ESD areas

ESD Basic is the low-cost ESD model from Bimos which provides excellent value for money: With its ergonomic design, high standard of user comfort and reliable ESD protection

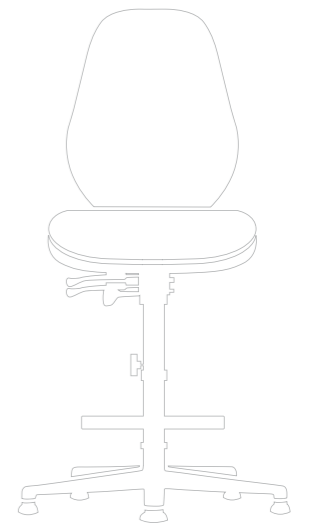

system that ensures a discharge resistance in accordance with EN 61340-5-1, it has all the essential attributes of a high-performance workplace chair that has been designed specifically for the electronics industry.



The characteristics of the Bimos ESD protection system

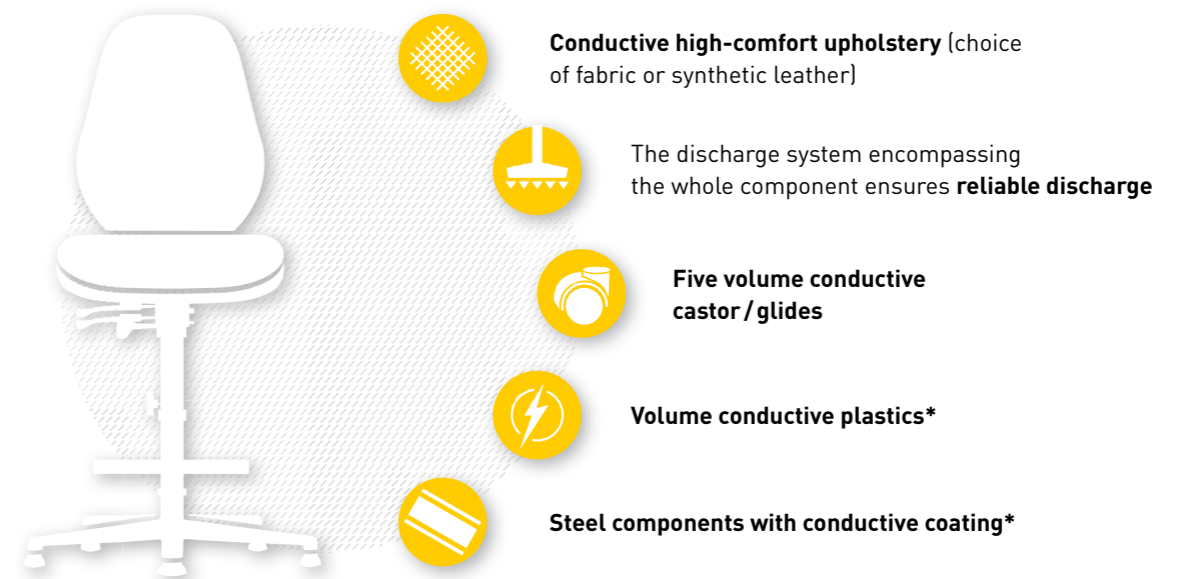

* These features only apply in the case of the ESD plus option.

Available in two different frame colours



+32 (0)9 232 06 78

info@awp.be

Destelbergen



ESD Basic

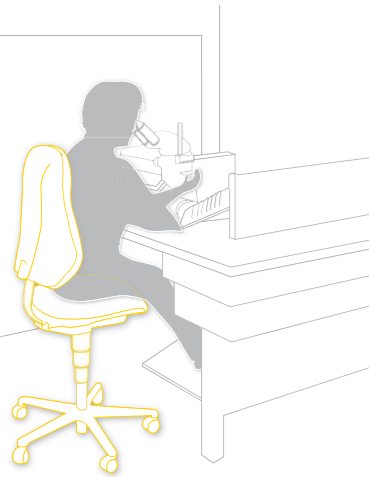

Design and materials

ESD Basic has conductive covers. It features a sturdy five-legged base frame with flat lines, which is made from epoxy-resin coated sectional steel tubing and provides good stability. The frame is available in either black or light grey.

Mechanisms and functions (for precise details, see pages 16 – 17)

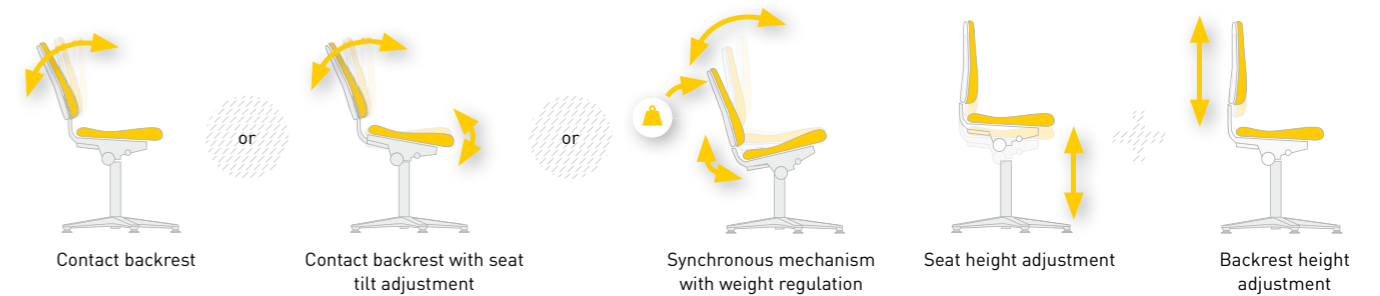

Options



Polished aluminium 5 star base

Light grey frame

ESD plus option

Accessories (for precise details, see page 149)



Ring-shaped armrest, black

Ring-shaped armrest, light grey

ESD multi-function armrest

Foot ring

Upholstery finish and colour options

Finish Black Blue Grey Red

Duotec ESD fabric

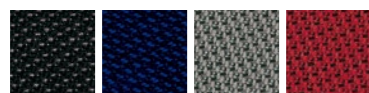

Order no.

9801

9802

9811

9803

Skai ESD synthetic leather



Order no.

2571



ESD Basic 1 with glides

Seat height adjustment range*: 470 to 610 mm.

Design	Height of backrest	Order no.
Contact backrest	430 mm	9150E-Colour no.
Contact backrest with tilting seat	530 mm	9154E-Colour no.



ESD Basic 2 with castors

Seat height adjustment range*: 470 to 610 mm.

Design	Height of backrest	Order no.
Contact backrest	430 mm	9151E-Colour no.
Contact backrest with tilting seat	530 mm	9155E-Colour no.



ESD Basic 3 with glides and step

Seat height adjustment range: 620 to 870 mm (630 to 890 mm*/660 to 910 mm**).

Design	Height of backrest	Order no.
Contact backrest	430 mm	9152E-Colour no.
Contact backrest with tilting seat*	530 mm	9156E-Colour no.
Contact backrest with synchronous mechanism with weight regulation	530 mm	9159E-Colour no.

+32 (0)9 232 06 78

info@awp.be

Destelbergen



ESD Unitec



The low-cost solution for solid performance

If you are looking for a budget-priced, basic model for use in ESD areas, ESD Unitec is a straightforward yet solid option. It offers all the standard functions and can be easily adjusted by the user. ESD Unitec is ideal for workplace situations that involve standing up as well as sitting down. Unitec has a

generously proportioned seat and a high backrest. Comprehensive discharge capability is not a requirement for many areas. Therefore, ESD Unitec does not feature the conductive plastic components and steel components with conductive coating found on our other ESD models. Nevertheless, there is absolutely no compromise in terms of how the upholstery manages to direct electrostatic charges down to the conductive base.



The characteristics of the Bimos standard ESD protection system



Conductive high-comfort upholstery (choice of fabric or synthetic leather)



Five volume conductive castors / glides



Whole-product dissipation achieved by interconnecting all the components ensures that **static electricity is reliably discharged**



Volume-conductive plastic back shell



Standard functions for first-time buyers

- Seat height adjustment
- Backrest height adjustment
- Contact backrest

+32 (0)9 232 06 78

info@awp.be

Destelbergen



ESD Unitec

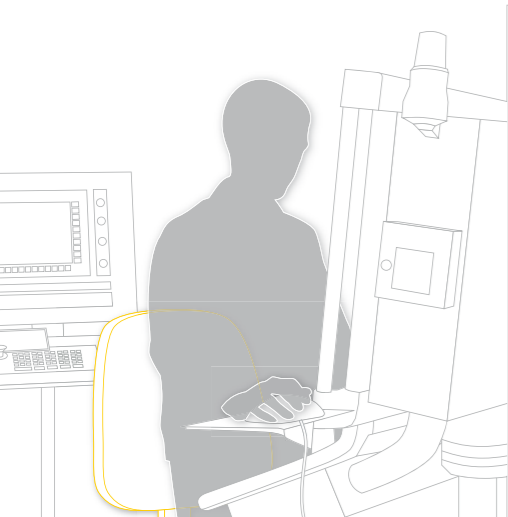

Design and materials

All the ESD Unitec upholstery options have appropriate antistatic properties. ESD Unitec features a sturdy five-legged base frame with flat lines made from sectional steel tubing. The colour of the frame is black.

Mechanisms and functions (for precise details, see pages 16 – 17)



Accessories (for precise details, see page 149)



Ring-shaped armrest Multi-function armrest ESD Foot ring for Unitec Stop & Go castors



ESD Unitec 1 with glides

Seat height adjustment range: 440 to 590 mm.

Design	Order no.
Duotec ESD fabric	9650E-Colour no.



ESD Unitec 2 with castors

Seat height adjustment range: 440 to 590 mm.

Design	Order no.
Duotec ESD fabric	9653E-Colour no.



ESD Unitec 3 with glides and foot ring

Seat height adjustment range: 580 to 850 mm.

Design	Order no.
Duotec ESD fabric	9651E-Colour no.
leather, black	9651E-2571

Finish and colour options for seat and backrest

Finish	Black	Blue	Grey	Red
Duotec ESD fabric				
Order no.	9801	9802	9811	9803
Skai ESD synthetic leather				
Order no.	2571			

ESD Stools, ESD Footrests



ESD



Industrious assistants

Some of the tasks associated with ESD areas call for elevated seating positions or require workers to stand for long periods or to alternate between standing up and sitting down. As a result, their bodies are often subjected to a great deal of physical stress. Bimos has the answer to these requirements: stools and footrests suitable for ESD areas that support the human body and relieve physical stress.

Stool functions

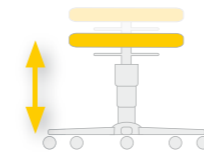

Seat height adjustment based on pneumatic spring system with easy ring control

Footrest functions

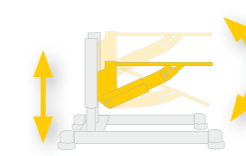

Pedal buttons enable convenient footrest adjustment while seated

Stool options



Polished aluminium
5 star base

Foot ring

Finish and colour options for seat (stools)

Finish	Black	Blue	Grey	Red
Duotec ESD fabric				
Order no.	9801	9802	9811	9803
Skai ESD synthetic leather				
Order no.	2571			



ESD stool

With conductive fabric or synthetic leather upholstery. Conductive castors or glides.

Design	Seat height	Order no.
with glides	460 - 630 mm	9467E-Colour no.
with castors	460 - 630 mm	9468E-Colour no.

ESD Footrests

Height adjustment range: 100 to 340 mm.
Tilt adjustment range: 8° to 25°.
Conductive rubber tread.

Design	Order no.
Conductive glides	9455E-217

Laboratory

**“Safety is a matter
of cleanliness –
even in chairs.”**

 +32 (0)9 232 06 78

 info@awp.be

 Destelbergen



Laboratory

Sophisticated seating solutions for your laboratory

Laboratory work imposes unique seating requirements, which are unlike those of any other working environment. As well as the need for maximum hygiene and easy cleaning, laboratory chairs also have to meet a number of other requirements associated with routine laboratory tasks:

They have to allow for flexibility in terms of the work and must not take up too much space. Nevertheless, expectations remain high in respect of ergonomics and comfort, as laboratory tasks call for fine motor skills, and high levels of precision and concentration. The flexible configuration options take the strain out of demanding tasks that involve leaning forwards such as microscope or pipette work. The materials used are washable, can be disinfected and some even feature an antibacterial coating. During production, the utmost care is taken to ensure that there are no seams or gaps that could encourage germs or bacteria to grow. Yet at the same time, aesthetic appearance must not be compromised. The design and the colour variants fit perfectly into every laboratory. So Bimos laboratory chairs – particularly our unique flagship Labster – are the solution of choice, whenever seating is needed in the laboratory.



The ideal attributes for any laboratory

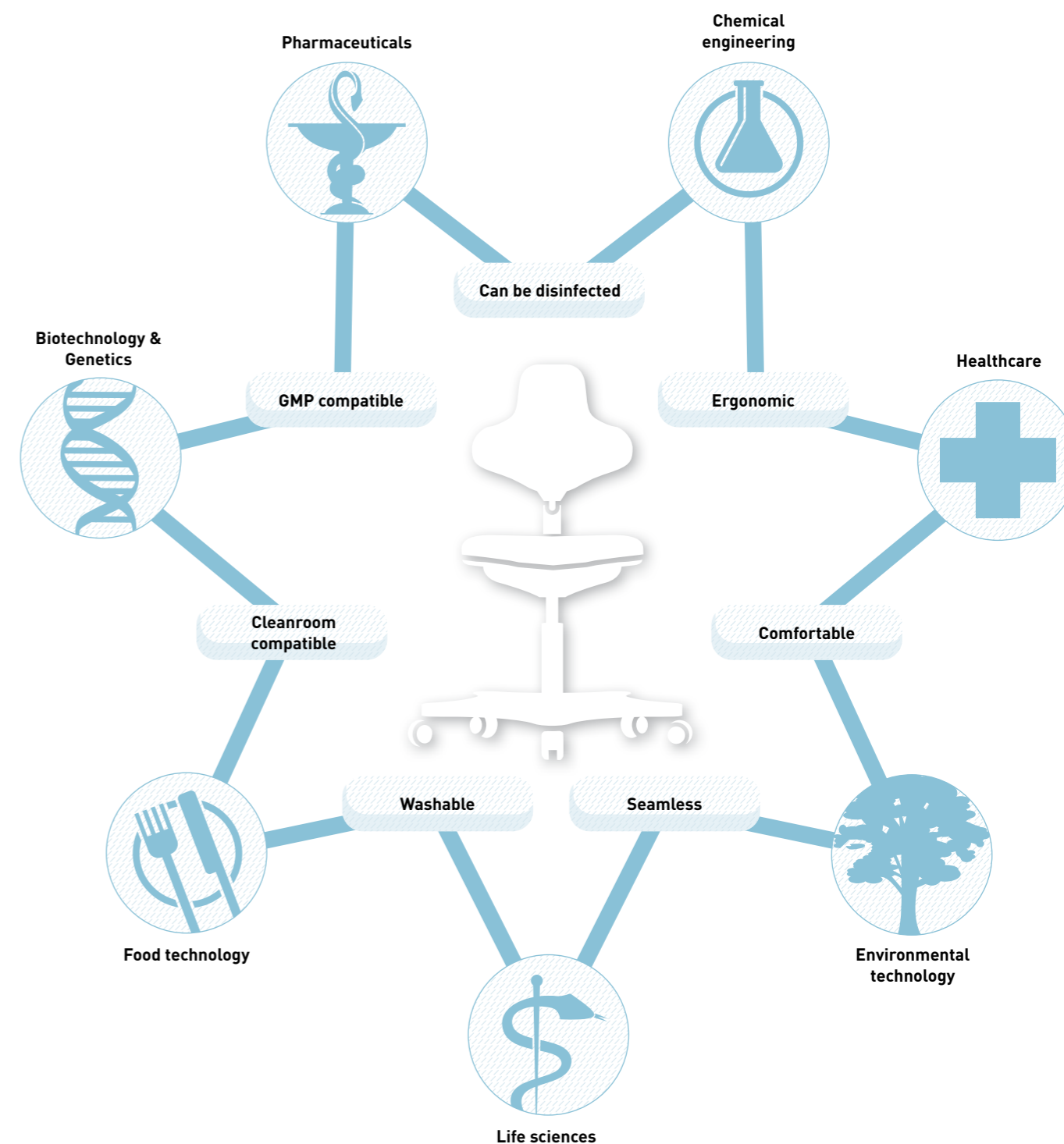

Labster



The world's first real laboratory chair

Labster is the world's first real laboratory chair. Unlike the usual laboratory adaptations of office or workshop chairs, Labster has been specially designed for the requirements of a laboratory. Labster has no sharp edges, thanks to its unique, seamless design concept, where even the mechanism is hidden under the soft, washable cover. There are no nooks and crannies where

microorganisms can lurk. All the surfaces can be cleaned quickly and thoroughly. In terms of ergonomics, Labster leaves nothing to be desired. For instance, the newly developed auto-motion technology ensures that the angle between the back and the thighs is always correct, no matter what type of work is being performed. This is not so surprising when you consider that Labster was designed on the basis of results of the Fraunhofer laboratory user study **Lab|2020**. So Labster sets new standards – it is even suitable for use in cleanroom conditions.

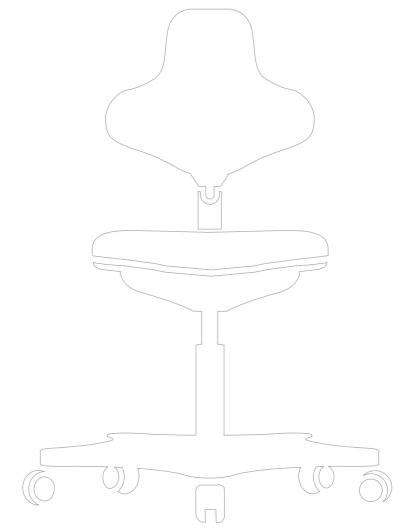

The factors that make Labster the world's first pure laboratory chair



Fraunhofer
TESTED
DEVICE
bmos
Stuhl & Stuhlteile Labster
Report No. IS 0708-415



Ideal for labs in terms of ergonomics, function and comfort

- High level of comfort thanks to Skai synthetic leather and soft upholstery
- Superb ergonomics thanks to anatomically designed and task-oriented seat and back
- Height-adjustable backrest provides optimum support for the lumbar region
- Extremely user-friendly

Dynamic support thanks to auto-motion technology

- The special auto-motion technology is particularly suited to the leaning position that is typical of laboratory tasks.
- The seat and backrest respond dynamically to the movements of the upper body and thereby ensure the correct seat angle.

Hygiene and cleanliness

- All materials are resistant to disinfectants
- No gaps or seams
- Easy to disinfect
- Completely washable
- Mechanism is tucked away under a soft cover with integrated control panel

Adapts perfectly to everyday laboratory tasks

- Compact design
- Space-saving star base
- Attractive colour and shape concepts to complement the laboratory
- Complete product line for any workplace scenario

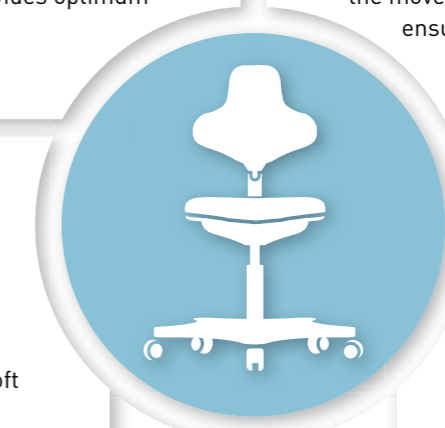

Meets the highest laboratory standards

- Design complies with GMP guidelines
- Meets the requirements of S1, S2 and S3 (safety class) biotechnology labs
- Air cleanliness class 3 in accordance with

+32 (0)9 232 06 78

info@awp.be

Destelbergen



Labster

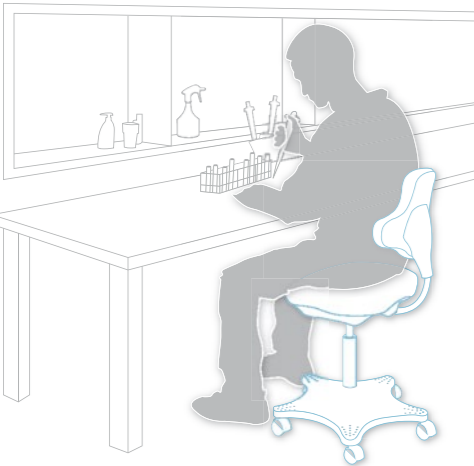

Design and materials

The ergonomically shaped comfort upholstery of Labster chairs is available either with the very soft Skai synthetic leather or with the very sturdy integral foam. Both surfaces are easy-care and resistant to disinfectants. Whereas you can choose between black and grey for the integral foam models, the synthetic leather is also available in blue, red, mint and white. The frame for all models is platinum grey.

Mechanisms and functions (for precise details, see pages 16 – 17)

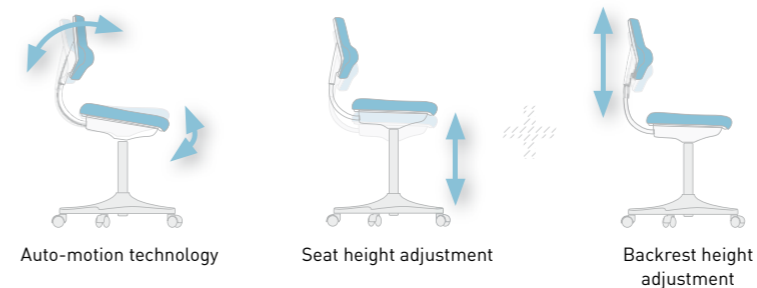

Stool function

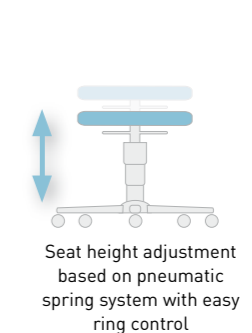

Options



Seat height of 450 to 650 mm with Labster 2

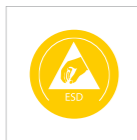

ESD features

Accessories (for precise details, see page 149)



Foot ring for Labster 2



Polished aluminium base

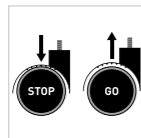

Stop & Go castors

Upholstery finish and colour options

Finish	Black	Blue	Grey	Red	Mint	White
Skai synthetic leather						
Order no.	2571	6902	6911	6903	6914	6907
Integral foam						
Order no.	2000		2002			



Labster 2 with castors

Seat height adjustment range: 400 to 510 mm.
Option: 450 to 650 mm.

Design	Order no.
Skai synthetic leather	9103-Colour no.
Integral foam	9103-Colour no.
Skai synthetic leather ESD with aluminium base	9103E-2571



Labster 3 with glides and foot ring

Seat height adjustment range: 550 to 800 mm.

Design	Order no.
Skai synthetic leather	9101-Colour no.
Integral foam	9101-Colour no.
Skai synthetic leather ESD with aluminium base	9101E-2571



Labster stool with castors

Seat height adjustment range: 450 to 650 mm.

Design	Order no.
Skai synthetic leather	9107-Colour no.
Integral foam	9107-Colour no.
Skai synthetic leather ESD with aluminium base	9107E-2571
with aluminium base	9107E-2000

+32 (0)9 232 06 78

info@awp.be

Destelbergen



Neon laboratory

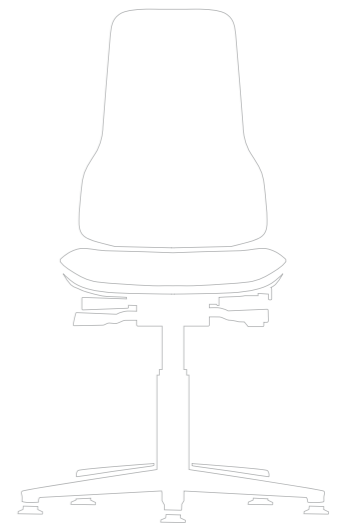

Laboratory

Comfort in your laboratory

Neon, the new generation workplace chair, cuts a fine figure in the laboratory too. Neon supports the forward-leaning sitting position that is often necessary in work in the laboratory. Neon is very elegant; its modern design matches the high-tech laboratory environment perfectly. Of course the laboratory version of Neon has all the characteristics you would

expect of a good laboratory chair. It is seamless, easy to clean, washable, and resistant to disinfectants. So Neon is always the ideal solution for the laboratory, when a really comfortable chair is needed. In addition to its outstanding ergonomic features, Neon is above all extremely comfortable. Its thick but deceptively slim-line upholstery ensures that sitting down even for a long test series is still comfortable. Its very sophisticated mechanisms support the body in its every movement. Yet Neon is quite simple. Operation is self-explanatory. The best ergonomic features are only really effective when the user understands them and wishes to put them to use.



reddot design award
winner 2013



+32 (0)9 232 06 78

info@awp.be

Destelbergen



Neon laboratory

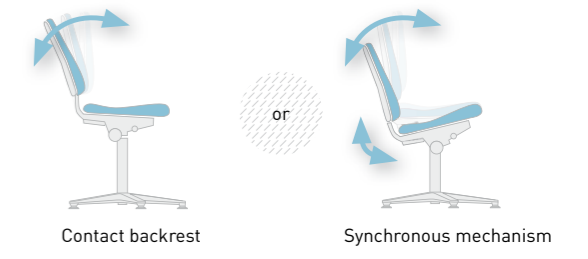

Mechanisms (for precise details, see pages 16 – 17)

Design and materials

Neon is made of solid steel with an aluminium base. In the standard version, all the metal parts are black. On request, the base is also available in polished aluminium. In the laboratory version, the tough plastic parts are basalt grey. Neon is available with a choice of castors with load-sensitive brakes for hard floors or with abrasion-resistant glides. In addition, for the high version, there are optional Stop & Go castors available. The most striking feature of Neon is its flex strip. It is made of soft plastic and serves to protect the chair and its environment. There is a choice of three modern colours for the flex strip.

Ergonomics package

(for precise details, see pages 16 – 17)

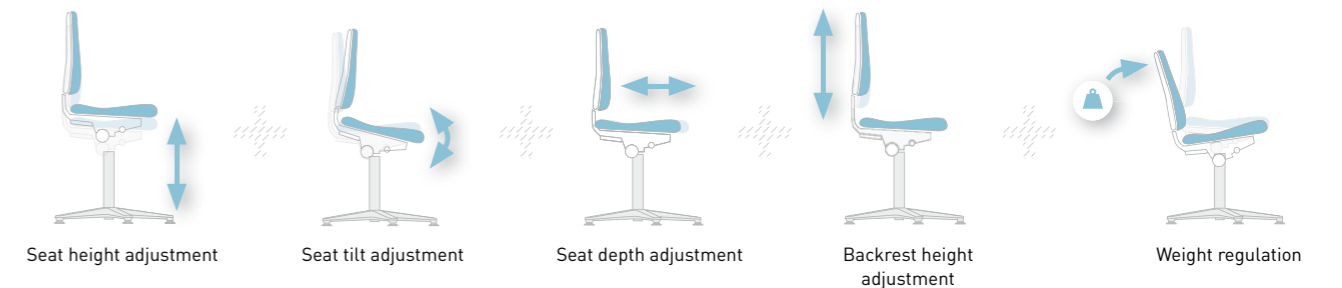

Options



Polished aluminium
5 star base

Accessories

(for precise details, see page 149)



Multifunction armrest

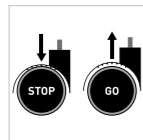

Stop & Go castors



Neon 1 with glides

Seat height adjustment range: 450 to 620 mm.

Design

Permanent contact inc. ergonomics package

Order no.

9560-Flex strip colour



Neon 2 with castors

Seat height adjustment range: 450 to 620 mm.

Design

Permanent contact inc. ergonomics package

Order no.

9563-Flex strip colour



Neon 3 with mounting aid and glides

Seat height adjustment range: 590 to 870 mm.

Design

Permanent contact inc. ergonomics package

ology inc. ergonomics package

Order no.

9561-Flex strip colour

9571-Flex strip colour

Flex strip colour

	orange	green	grey	blue
Flex strip				
Order no.	3279	3280	3278	

+32 (0)9 232 06 78

info@awp.be

Destelbergen









Neon laboratory

Design and materials

Neon's innovative 1+1 system allows you to change the upholstery quickly and easily with a single click. With the 1+1 system, you order chair and upholstery elements separately (please note that you can only sit on the chair with an upholstery element). For use in laboratory areas, you can choose between two materials: an extremely

tough and pleasant-feeling structured integral foam, or soft and comfortable Magic synthetic leather. Both upholstery options are easy to look after, washable, and resistant to disinfectants. The 1+1 system makes Neon not just very comfortable, but also an extremely durable laboratory chair.

Upholstery finish and colour options

Finish	Black	Blue	Grey	White
Magic synthetic leather				
Order no.	MG01	MG02	MG11	6907 (Skai)
Integral foam				
Order no.	2000	2001	2002	

Upholstery easy to change



Neon synthetic leather upholstery

washable, easy care, soft and comfortable, resistant to disinfectants

Design

Order no.



Neon integral foam upholstery

extremely robust, durable, washable, resistant to mechanical damage, mild acids and alkalis

Design

Order no.

9588-Colour no.

Labsit

Simply clever

Labsit impresses with its intelligence and simplicity. It has been proven to have all of the features required for a laboratory workstation and at the same time is lightweight, can be used universally and provides outstanding value for money. Its intelligent flex function provides comfort and ergonomic seating in the laboratory with a minimum of settings. Labsit can be used as a specialist laboratory seat or allrounder and also impresses with its excellent design.



Ideal for use in laboratories

Numerous independent expert reports confirm that Labsit is ideally suited for use in laboratories. Labsit's hygienic design makes it perfect for multiple sectors, from pharmaceutical, biotech, chemicals, health care and clean room to medical technology.

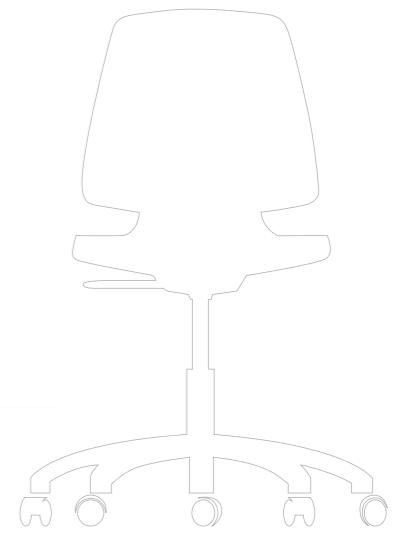

GMP CONFORMS WITH GMP
Meets the requirements of the GMP regulations

MINIMUM JOINTS
Hygienic design for simple cleaning and disinfecting

ANTI-BACTERIAL
Faux leather padding, highly effective against germs (sanitised)

EASY TO DISINFECT AND RESISTANT TO CHEMICALS
Resistant to all common disinfectants and chemicals in accordance with ISO 2812 (Fraunhofer)

SUITABLE FOR CLEAN ROOMS
For use in Class 3 clean rooms in accordance with ISO 14644-1 (Fraunhofer)

S1-3 CAN BE USED IN BIOTECHNOLOGY LABORATORIES
In accordance with safety classifications S1, S2 and S3 of the Ordinance on Biological Agents (Biostoffverordnung)

DOES NOT CONTAIN ANY HAZARDOUS MATERIALS
No toxic agents and emissions (TÜV Rheinland)

GS CERTIFIED
Top safety (TÜV Rheinland)

+32 (0)9 232 06 78

info@awp.be

Destelbergen



Labsit

Best design for successful work



+32 (0)9 232 06 78

info@awp.be

Destelbergen



Labsit

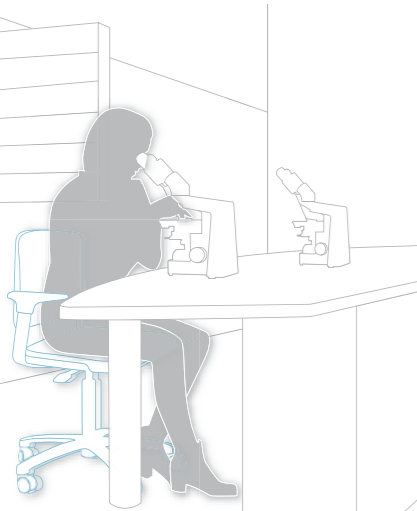

Models and materials

In the laboratory, the perfect cleaning process starts with the material. Labsit's back rest is made from faux leather with 3D flex function. Depending on requirements, Labsit can be supplied with integral foam or faux leather padding for laboratories and material or Supertec padding for other uses. The characteristic seat shell comes in five attractive colours. The back rest is available in black only. The cross-shaped base is available in black plastic or polished aluminium. All of the plastic and PU parts of the stool are black. The 5-star base is also available in black plastic or polished aluminium. The optional Lab-Clip makes it easy to attach individual labels to the chair. The ESD-compliant Labsit model comprises a cross-shaped base made from polished aluminium, a black seat shell and four padding material options.

Stool functions



Seat height adjuster with gas spring with ring trigger

Functions



3D flex function back rest

Flex function front edge of seat

Seat height adjuster



Labsit stool with castors

Seat height adjustable from 450 mm to 650 mm.

Design	Order no.
Integral foam black	9127-2000
Integral foam ESD black	9127E-2000

Options

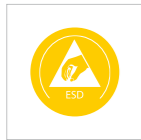

ESD (Seat shell= Black)



Polished aluminium 5-star base (ESD standard)

Accessories (for precise details, see page 149)



Multi-function armrest 9129



Labsit 2 with foot ring



Lab-Clip 9128

Seat padding and shell

	Magic synthetic leather	Integral foam	Fabric Lucia	Supertec		
Seat padding						
Order no.	MG01/ ESD MG01	2000/ ESD 2000	5800/ ESD fabric Duotec 9801	SP01/ ESD CP01		
Seat shell						
Order no.	3277	3285	3403	3279	3280	3218
	Blue	Anthracite	White	Orange		



Labsit 2 with castors

Seat height adjustable from 450 mm to 650 mm.

Design	Order no.
Magic synthetic leather black	9123-MG01-colour seat shell
Integral foam black	9123-2000-colour seat shell
Fabric Lucia black	9123-5800-colour seat shell
Supertec black	9123-SP01-colour seat shell
Magic synthetic leather ESD black	9123E-MG01-3218
Integral foam ESD black	9123E-2000-3218
Fabric Duotec ESD black	9123E-9801-3218



Labsit 3 with glides and foot ring

Seat height adjustable from 520 mm to 770 mm.

Design	Order no.
Magic synthetic leather black	9121-MG01-colour seat shell
Integral foam black	9121-2000-colour seat shell
Fabric Lucia black	9121-5800-colour seat shell
Supertec black	9121-SP01-colour seat shell
Magic synthetic leather ESD black	9121E-MG01-3218
Integral foam ESD black	9121E-2000-3218
Fabric Duotec ESD black	9121E-9801-3218



Labsit 4 with Stop & Go castors and foot ring

Seat height adjustable from 560 mm to 810 mm.

Design	Order no.
Magic synthetic leather black	9125-MG01-colour seat shell
Integral foam black	9125-2000-colour seat shell
Fabric Lucia black	9125-5800-colour seat shell
Supertec black	9125-SP01-colour seat shell
Magic synthetic leather ESD black	9125E-MG01-3218
Integral foam ESD black	9125E-2000-3218
Fabric Duotec ESD black	9125E-9801-3218
varz	9125E-CP01-3218

Labor Nexxit

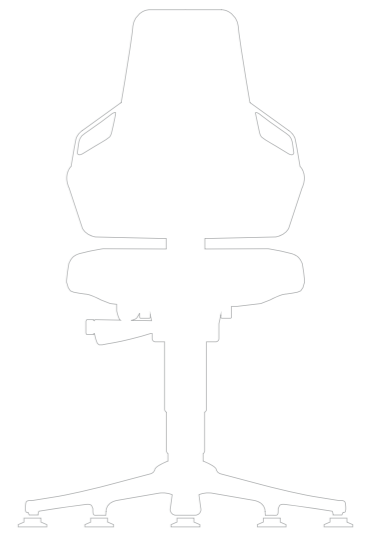

Your perfect partner when working in the laboratory

The Nexxit is optimised for use in the laboratory, as well as being user friendly and offering ergonomic support. Its synchronous mechanism with automatic weight adjustment adapts readily to the user's weight and performs the essential

basic adjustments, thereby automatically ensuring that the user is sitting correctly. In order to meet the various user requirements as well as the vast array of different work requirements for a laboratory, the range of motion of the Nexxit Laboratory's backrest can be adjusted to one of three different settings.



<p>Magic synthetic leather</p> <ul style="list-style-type: none"> • Washable and easy care • Soft and comfortable • Resistant to disinfectants • Antibacterial • PVC-free 	<p>Integral foam (PU)</p> <ul style="list-style-type: none"> • Extremely robust, durable • Washable • Withstands mechanical influences • Resistant to flying sparks • Resistant to weak acids and alkalis 
---	---

3-level pre-selection

The right working range for every task. In order to meet the different work requirements, the range of motion of the Nexxit's backrest can be adjusted to one of three different settings:

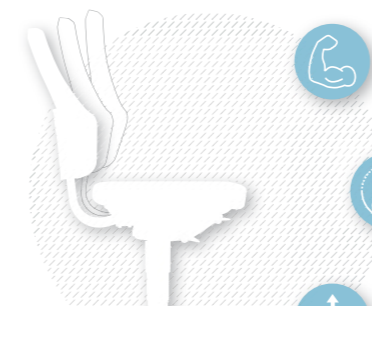

Setting 1 locks the backrest in place, providing optimal support for work that requires a lot of force or effort.

Setting 2 allows for dynamic sitting with a medium range of motion for precision mechanical activities, e.g. activities in which the user is working with their eye close to the workpiece.

Setting 3 offers the full range of motion where ample

+32 (0)9 232 06 78

info@awp.be

Destelbergen



Labor Nexxit



Design and materials

The Nexxit offers excellent support for any user and any task in the laboratory thanks to its impressive ergonomic design, and its superlative sitting comfort and extreme durability and resistance make it a standout product. The materials used are easy to clean, hard-wearing and robust. This makes the Nexxit Laboratory the perfect long-term partner for your work – especially in laboratories in which chairs are subject to intensive use and stresses. The Nexxit's practical, functional handles are available in different colours, adding a striking design feature to liven up any laboratory.

Ergonomic package (for a detailed description, see p. 16-17)

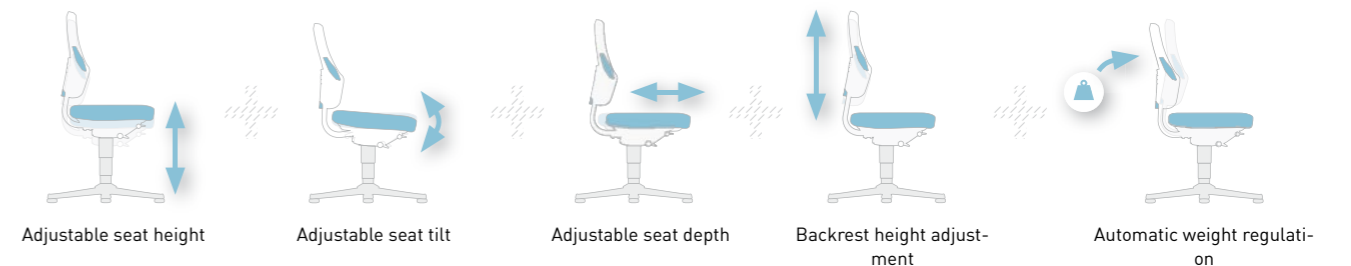

Accessories (for a detailed description, see p. 149)

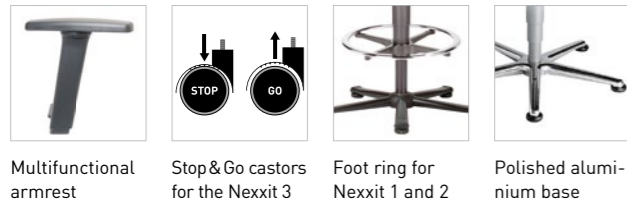

Upholstery cover materials

Cover material	Magic synthetic leather	Integral foam (PU)
Order No.	MG01	2000

Handle colours

Colours	Blue	Grey	Orange	Green	No handles
Order No.	3277	3278	3279	3280	3001



Nexxit 1 with glides

Seat height adjustment range: 450 to 600 mm.

Design	Order No.
Magic synthetic leather	9030-MG01



Nexxit 2 with castors

Seat height adjustment range: 450 to 600 mm.

Design	Order No.
Magic synthetic leather	9033-MG01



Nexxit 3 with glides and foot ring

Seat height adjustment range: 570 to 820 mm.

Design	Order No.
Magic synthetic leather	9031-MG01
	9031-2000

Basic Laboratory

The tried-and-tested all-rounder for use in laboratories

Basic Laboratory is the low-cost laboratory model from Bimos. However, even this basic version features all the essential attributes. Consequently, Basic Laboratory is a good entry-level model for laboratories with straightforward requirements.



Upholstery with Skai synthetic leather covering – A bacteria-free zone

- Antibacterial
- Antifungal
- Antimicrobial



Choice of three different mechanisms

- Contact backrest
- Contact backrest with seat tilt adjustment
- Synchronous mechanism with weight regulation



Available in two different frame colours

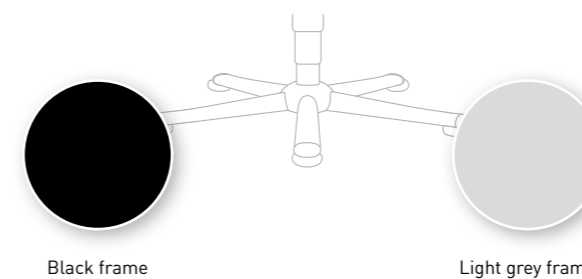

+32 (0)9 232 06 78

info@awp.be

Destelbergen



Basic Laboratory



Design and materials

Basic Laboratory can be supplied with Skai synthetic leather or with fabric upholstery. Not only is Skai easy to clean, but it also has antibacterial, antifungal and antimicrobial properties. Basic Laboratory features a sturdy steel 5 star base. The frame is available in either black or light grey.

Mechanisms and functions (for precise details, see pages 16 – 17)

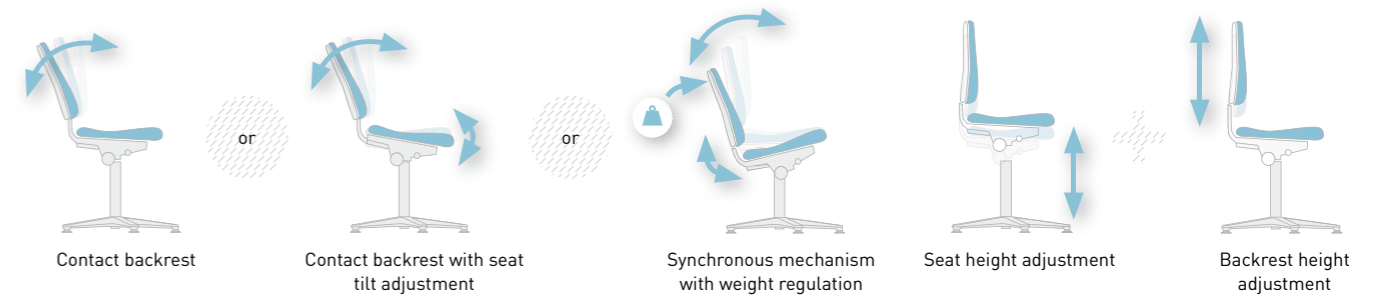

Accessories (for precise details, see page 149)



Ring-shaped armrest, black
Ring-shaped armrest, light grey
Multifunction armrest



Foot ring
Stop & Go castors

Options



Light grey frame



Polished aluminium 5 star base



Basic Laboratory 1 with glides

Seat height adjustment range*: 470 to 610 mm.

Design	Height of backrest	Order no.
Contact backrest	430 mm	9130-Colour no.
Contact backrest with tilting seat	530 mm	9132-Colour no.



Basic Laboratory 2 with castors

Seat height adjustment range*: 470 to 610 mm.

Design	Height of backrest	Order no.
Contact backrest	430 mm	9133-Colour no.
Contact backrest with tilting seat	530 mm	9134-Colour no.



Basic Laboratory 3 with glides and step

Seat height adjustment range: 620 to 870 mm (630 to 890 mm* / 660 to 910 mm**).

Design	Height of backrest	Order no.
Contact backrest	430 mm	9131-Colour no.
Contact backrest with tilting seat*	530 mm	9137-Colour no.
Contact backrest with tilting seat**	530 mm	9136-Colour no.

Upholstery finish and colour options

Finish	Black	Blue	Grey	Red
Skai synthetic leather				
Order no.	2571	6902	6911	6903
Duotec fabric				
Order no.	6801	6802	6811	

Cleanroom

**“Zero-emission chair
affords pure
sitting pleasure.”**

 +32 (0)9 232 06 78

 info@awp.be

 Destelbergen



Cleanroom

Indispensable – Certified top-of-the-range seating for use in cleanrooms

In order to create “clean” or “sterile” rooms, measures have to be implemented to prevent products and processes from becoming contaminated. This is a key requirement of the microelectronics sector, the pharmaceuticals industry, microsystem production, optics, medical engineering and healthcare. That is why Bimos has worked together with industry and research specialists to develop its innovative range of cleanroom chairs for use in extreme conditions.

We put our claims regarding the quality of these chairs to the test on a daily basis by subjecting them to a comprehensive series of tests that prove the low level of particle emissions and the reliability of the electrostatic discharge measures used. This quality is also borne out by empirical evidence arising from day-to-day use.

Bimos cleanroom chairs boast astounding properties and meet the requirements of air cleanliness classification 3 in accordance with DIN EN ISO 14644-1, cleanroom classification 1 as defined by US Federal Standard 209E and the specifications of the EU GMP guidelines.

Bimos	Air cleanliness classification to:			Particle size and permissible number of particles per cubic metre of air acc. to DIN EN ISO 14644-1				
	DIN EN ISO 14644-1	EU GMP guidelines	US-Fed St. 209E	≥ 0,1 µm	≥ 0,2 µm	≥ 0,3 µm	≥ 0,5 µm	≥ 1,0 µm
	1	–	–	10	2	–	–	–
2	–	–	100	24	10	4	–	–
3	–	1	1000	237	102	35	8	–
4	–	10	10.000	2.370	1.020	352	83	–
5	A/B	100	100.000	23.700	10.200	3.520	832	–
6	–	1000	1.000.000	237.000	102.000	35.200	8320	–
7	C	10.000	–	–	–	352.000	83.200	–
8	D	100.000	–	–	–	3.520.000	832.000	–

There are various definitions of cleanrooms, depending on the precise nature of the application and sector concerned. The table above provides an overview of various standards and how these relate to the Bimos classifications.

It is the sophisticated design coupled with the perfect implementation of that design that make Bimos cleanroom chairs top of their game.

Bimos ensures the following in respect of all its cleanroom chairs:

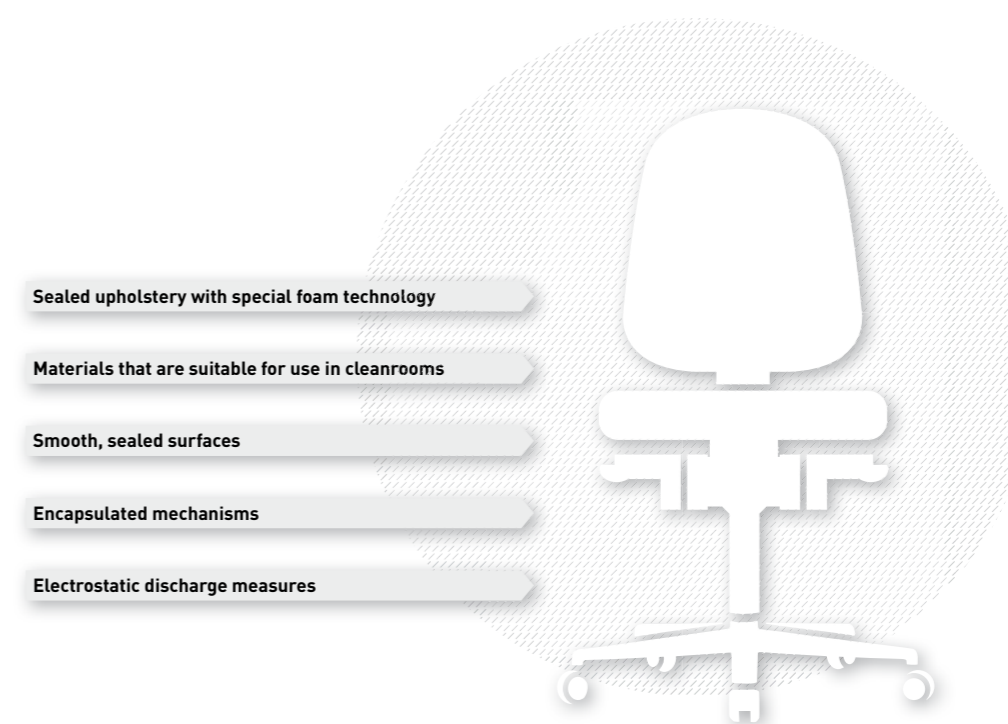

Cleanroom Plus

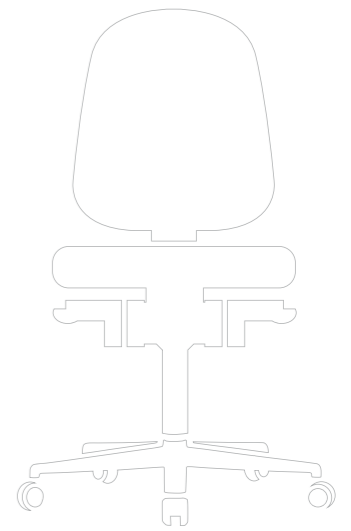

Cleanroom

The high-comfort solution for solid cleanroom performance

Our Cleanroom Plus chairs are the flagship of our cleanroom seating solutions. They offer excellent cleanroom properties and are equipped with a perfect electrostatic discharge system. Furthermore, these chairs cannot fail to impress with their superb ergonomic design and luxurious level of comfort. Consequently, Cleanroom Plus not only meets the technical requirements but also measures up to the expectations of those who work in cleanrooms every day.



Fraunhofer confirms the chairs' suitability for cleanrooms

The Fraunhofer IPA seal of approval certifies that Cleanroom Plus chairs are suitable for use in cleanrooms in compliance with the following standards:

- Air cleanliness classification 3 pursuant to DIN EN ISO 14644-1
- Air cleanliness classification 1 pursuant to US Fed. St. 209 E
- Provisions of the EU GMP guidelines
- Electrostatic discharge measures pursuant to EN 61340-5-1



Cleanroom properties



The smooth, sealed surfaces of the seat and backrest shells prevent swirl even when there is a constant flow of air through the filter system and stop the build-up of particles on the chair.

The synthetic leather, upholstery and upholstery support are permanently bonded using special foam technology to ensure that no particles can be emitted.

The sealed design of the seat and backrest cover means that all the moving parts of the chair's mechanical system are enclosed so that particles cannot escape.

All Bimos cleanroom chairs feature electrostatic discharge measures in accordance with EN 61340-5-1 and offer reliable antistatic protection.

The chairs are supplied with a brilliantly polished and abrasion-resistant aluminium 5 star base. The seat support and backrest cover are both made from sheet steel, making them sturdy and durable.

+32 (0)9 232 06 78

info@awp.be

Destelbergen



Cleanroom Plus



Design and materials

On Cleanroom Plus, the seat and backrest shells are made from sheet steel and provide optimum protection against particle emissions. The metal components have a conductive coating and the plastic components are volume conductive. These components are all light grey. The synthetic leather cover, which is also conductive, has non-slip properties and ensures a firm grip even when the user is wearing smooth cleanroom clothing.

Mechanisms and functions (for precise details, see pages 16 – 17)

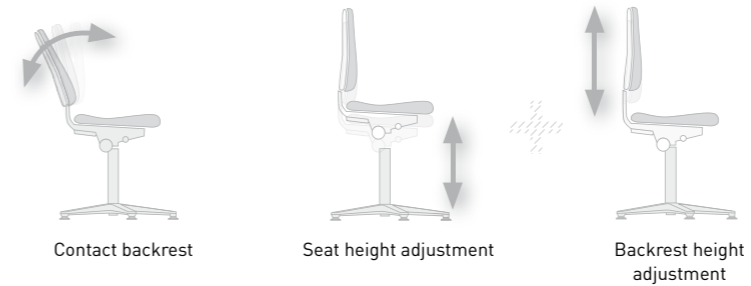

Options



Mushroom glides (Cleanroom Plus 2) Steel disc glides (Cleanroom Plus 3) Seat height adjustment range: 480 to 640 mm

Accessories (for precise details, see page 149)



Ring-shaped armrest Foot ring

Upholstery finish and colour options

Finish Black

Skai ESD synthetic leather

Order no. 2571



Cleanroom Plus 2
Height of backrest: 380 mm

Seat height adjustment range: 440 to 565 mm.
Option: 480 – 640 mm.

Design

Order no.



Cleanroom Plus 2
Height of backrest: 500 mm

Seat height adjustment range: 440 to 565 mm.
Option: 480 – 640 mm.

Design

Order no.



Cleanroom Plus 3
Height of backrest: 380 mm

Seat height adjustment range: 630 to 890 mm.

Design

Order no.

9183-2571

Cleanroom Basic

The tried-and-tested all-rounder for use in cleanrooms

An ergonomic design, superb cleanroom properties and reliable ESD measures are a lot to ask from a workplace chair. Yet Cleanroom Basic meets all these criteria and offers a high level of quality in the process. The fact that the chairs have to pass a comprehensive series of tests before they are awarded a test certificate and prove themselves in extreme working environments means that our claims of quality are not just empty words.

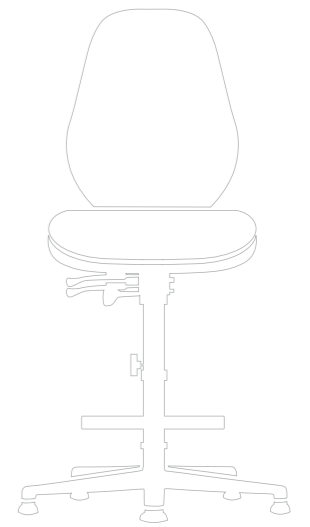

Fraunhofer confirms the chairs' suitability for cleanrooms

The Fraunhofer IPA seal of approval certifies that Cleanroom Basic chairs are suitable for use in cleanrooms in compliance with the following standards:

- Air cleanliness classification 3 pursuant to DIN EN ISO 14644-1
- Air cleanliness classification 1 pursuant to US Fed. St. 209 E
- Provisions of the EU GMP guidelines
- Electrostatic discharge measures pursuant to EN 61340-5-1



Fraunhofer
TESTED
DEVICE
Bimos 9140 aus Modellreihe Reinstaum Basic
Report No. IN 9912-165



Cleanroom properties



The smooth, sealed surfaces of the seat and backrest shells prevent swirl even when there is a constant flow of air through the filter system and stop the build-up of particles on the chair.

The synthetic leather, upholstery and upholstery support are permanently bonded using special foam technology to ensure that no particles can be emitted.

All Bimos cleanroom chairs feature electrostatic discharge measures in accordance with EN 61340-5-1 and offer reliable antistatic protection.

The chairs are supplied with a brilliantly polished and abrasion-resistant aluminium 5 star base. The seat support and backrest cover are made of plastic.

Cleanroom Basic

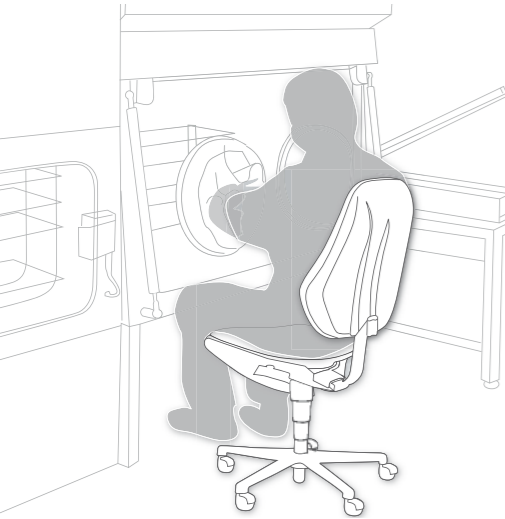

Design and materials

The base frame, which is made from die-cast aluminium, is brilliantly polished and is supplied with conductive castors/glides for hard floors. The non-tear synthetic leather cover, which is also conductive, has non-slip properties and ensures a firm grip even when the user is wearing smooth cleanroom clothing.

Mechanisms and functions (for precise details, see pages 16 – 17)

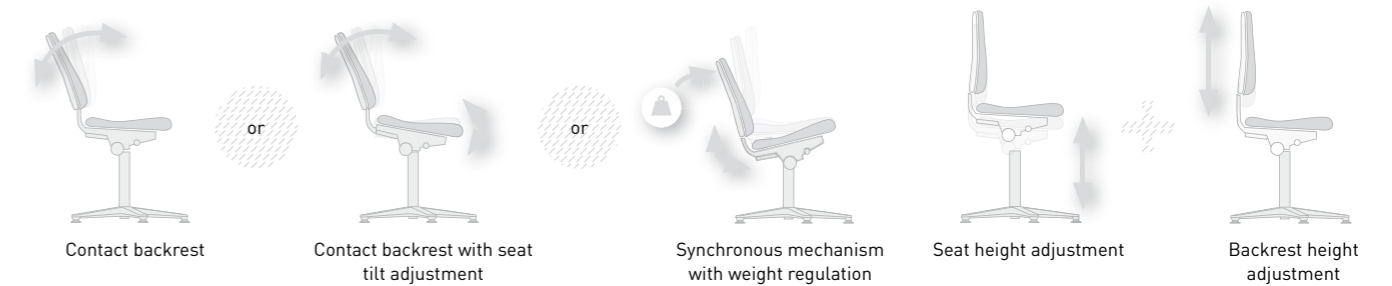

Options



Mushroom glides (Cleanroom Plus 2)

Accessories (for precise details, see page 149)



Ring-shaped armrest



Multifunction armrest



Foot ring

Upholstery finish and colour options

Finish **Black**

Skai ESD synthetic leather



Order no. **2571**



Cleanroom Basic 2 with castors

Seat height adjustment range*: 470 to 610 mm.

Design	Height of backrest	Order no.
Contact backrest	430 mm	9140-2571
Contact backrest with tilting seat	530 mm	9142-2571



Cleanroom Basic 3 with glides and step

Seat height adjustment range: 620 to 870 mm (630 to 890 mm*/660 to 910 mm**).

Design	Height of backrest	Order no.
Contact backrest	430 mm	9141-2571
Contact backrest with tilting seat*	530 mm	9143-2571
Synchronous mechanism with weight regulation**	530 mm	9146-2571

Cleanroom Stools



Fraunhofer
TESTED[®]
DEVICE
Interstuhl Höcker 9468R
Report No. IW 0312-300



Guarantee
10
Years



Industrious assistants

Stools provide an ad hoc seating solution for anywhere within the cleanroom. They can also be used instead of chairs when there is a lack of space. The comprehensive range of stools completes the Bimos cleanroom collection with these indispensable assistants. The base frames, which are made from die-cast aluminium, are brilliantly polished and are supplied with conductive castors/glides for hard floors. The synthetic leather cover also has conductive and non-slip properties.

Fraunhofer confirms the chairs' suitability for cleanrooms

The Fraunhofer IPA seal of approval certifies that Cleanroom Stools are suitable for use in cleanrooms in compliance with the following standards:

- Air cleanliness classification 4 pursuant to DIN EN ISO 14644-1
- Air cleanliness classification 10 pursuant to US Fed. St. 209 E
- Provisions of the EU GMP guidelines
- Electrostatic discharge measures pursuant to EN 61340-5-1

Functions (for precise details, see pages 16–17)

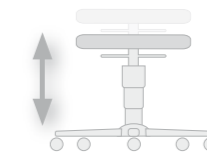

Seat height adjustment based on pneumatic spring system with easy ring control



Finish and colour options for seat (stool/ergonomic stool)

Finish **Black**

Skai ESD synthetic leather



Order no. **2571**

Cleanroom Ergo Stool 1 with glides

Seat height adjustment range: 460 to 630 mm.

Design

Order no.

Cleanroom Stool 2 with castors

Seat height adjustment range: 460 to 630 mm.

Design

Order no.

Cleanroom Stool 3 with glides and foot ring

Seat height adjustment range: 570 to 850 mm.

Design

Order no.

leather, black

9469R-2571

+32 (0)9 232 06 78

info@awp.be

Destelbergen



Standing work

“Relief from stress and strain when you have to stand all day – that’s a real gift.”



 +32 (0)9 232 06 78

 info@awp.be

 Destelbergen



Standing work

Relief from stress and strain for people who cannot sit down to work.

Almost every other member of the working population has to stand up to work for long periods of time. But standing up for prolonged periods subjects the human body to significant stress, and is responsible for a number of complaints relating to the heart and the circulatory and musculoskeletal systems.

There are some classic scenarios for standing work – when people have to change location often, or have to move around a lot, or have to communicate eye-to-eye with other people. A good standing rest needs to support a person doing these jobs, without getting in the way of the work itself. A standing rest must be space-saving, easy to transport from one place to another, and provide plenty of room for moving around and reaching things. At the same time, it must – the same as any seating solution – adapt to different body sizes, and support a person’s posture, without forcing them into a particular position.

Our solutions for standing work give you the perfect support for any activity that cannot be undertaken while sitting down. Our standing rests range from simple supports for short-term stress-relief up to flexible standing rests that allow you to stand for prolonged periods without any signs of fatigue.

You find standing work everywhere:

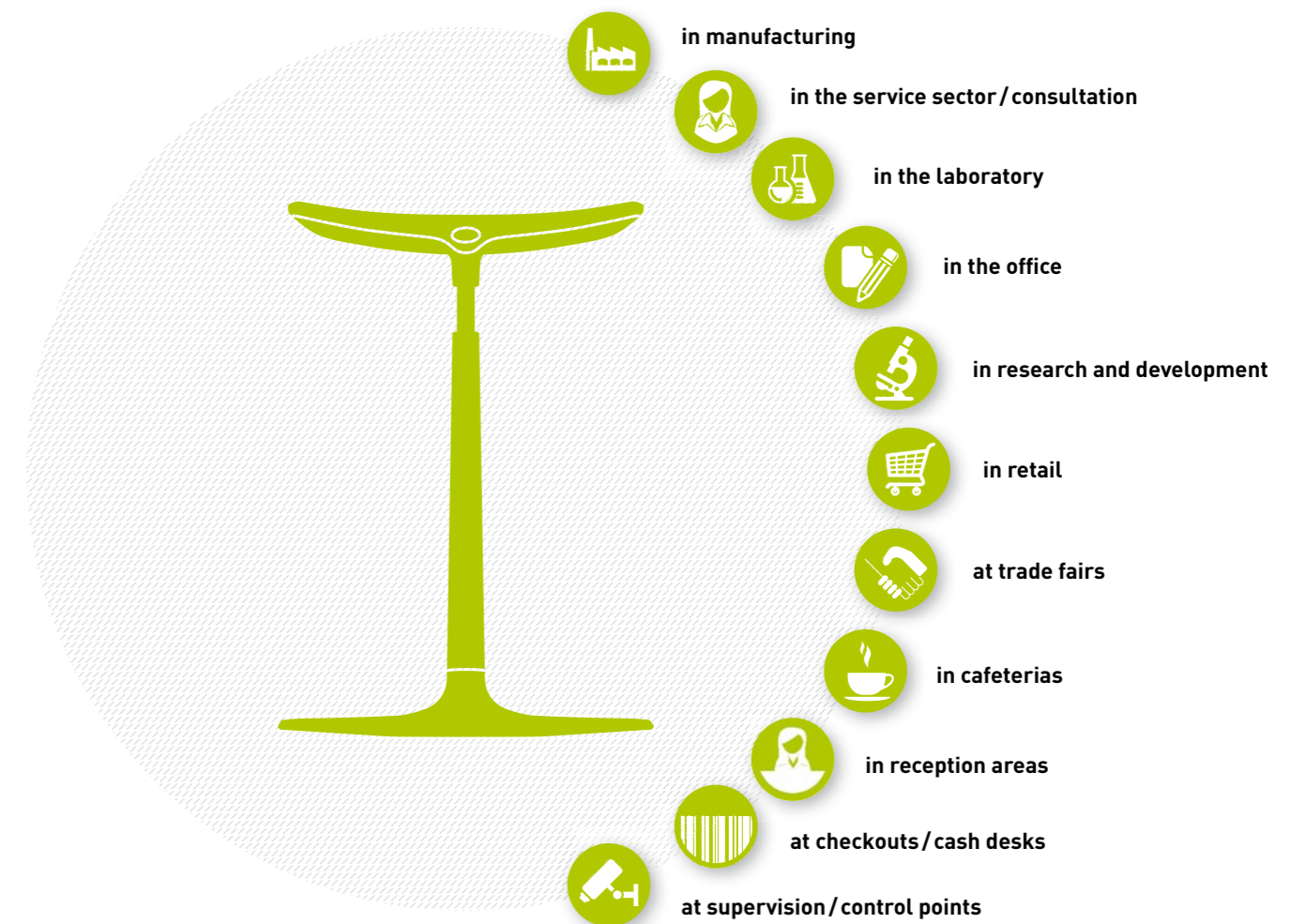

Fin / ESD Fin

The revolution in standing work

Fin is a fascinating new solution for practically every kind of standing work. It provides a completely new kind of sitting experience. Fin is incomparable, like no other standing rest on the market. It combines all the requirements demanded by work in industry, research, retail and office into an award-winning design. So Fin redefines standing work in a completely new way.

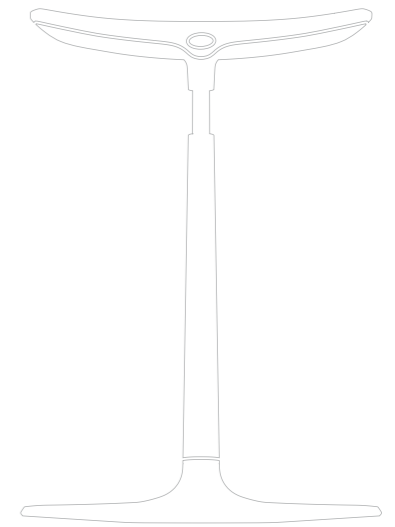

Standing work

Fin ...

- ... relieves stress, and is wonderfully comfortable,
- ... is completely intuitive to use and operate,
- ... is robust and easy to clean,
- ... is secure, and feels safe,
- ... is space-saving, light and easy to move around.

Fin was designed by one of the best design studios in Germany – Phoenix Design – and has received a Red Dot Award from the Design Centre in Nordrhein-Westfalen. So Fin also sets new aesthetic standards.

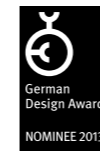

- **Practical: integral comfort handles**
- **Comfortable: extra-wide comfort seat**
- **Hardwearing: Soft Touch PU foam**
- **Dynamic: seat can be swivelled by 20°**

Simple: stepless height adjustment

Ergonomic: column tilts forward by 4° for optimum working posture and support

Resilient: comfortable gas spring

Safe: stable base

Flexible: changeable plastic and felt glides, depending on the kind of flooring

+32 (0)9 232 06 78

info@awp.be

Destelbergen



Fin / ESD Fin



Design and materials

Fin is made of aluminium and has a seat made of Soft Touch PU foam. In the standard version, the frame has a blasted aluminium surface. The base can also be supplied in anthracite on request. In the standard version, there are four seat colours available. In addition, there is also a conductive ESD version in black. The ESD version of Fin has a discharge resistance of $10^6 \Omega$, so fulfilling the requirements of ESD standard EN 61340-5-1.

Functions (for precise details, see pages 16 – 17)



Options



Aluminium base coated, anthracite

Finish and colours for seat model 9144

Finish	Black	Blue	Grey
Integral foam			
Order no.	2000	2001	2002

Finish and colours for seat model 9144E

Finish	Black
Integral foam ESD	
Order no.	2000



Fin

Seat height adjustment range: 620 to 850 mm.

Design	Order no.

ESD Fin

Seat height adjustment range: 620 to 850 mm

Design	Order no.
black	9144E-2000

Labster standing rest



Standing work

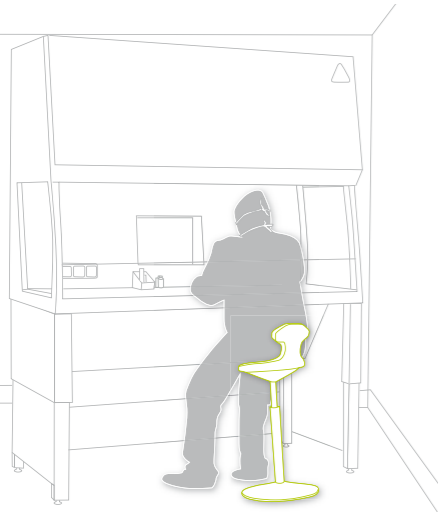

The standing rest for laboratory and more

Just like the Labster itself, the Labster standing rest was designed especially for use in the laboratory. A significant proportion of work in a lab is carried out standing and at various different stations. Work in a laboratory always requires high concentration and fine motor skills. The Labster standing rest is perfect for use in the laboratory: it is space-saving, designed without seams, has an enclosed mechanism, is easy to clean, and resistant to solvents and disinfectants. Its innovative rocker base makes for a dynamic standing-sitting experience, extending the radius of movement, and ensuring that the spine is always straight. So the Labster standing rest is perfect for taking away the strain of standing work in the laboratory, cleanroom, and workplaces with ESD requirements: and it conforms with air cleanliness class 3 in accordance with EN ISO 14644-1.

Functions (for precise details, see pages 16–17)

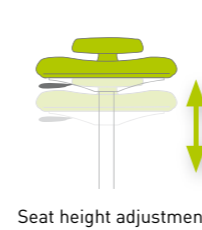

Seat height adjustment



Rocker base. Entire top section can be tilted by up to 7°

Options



Polished aluminium
5 star base

Finish and colour options for seat model 9106

Finish	Black	Grey
Integral foam		
Order no.	2000	2002

Finish and colour options for seat model 9106E

Finish	Black
Integral foam ESD	
Order no.	2000



Labster Laboratory, Cleanroom

Seat height adjustment range: 650 to 850 mm.

Design Order no.



Labster Laboratory, ESD, Cleanroom

Seat height adjustment range: 650 to 850 mm.

Design Order no.

black 9106E-2000

+32 (0)9 232 06 78

info@awp.be

Destelbergen



Industrial/ESD standing aid



Standing work

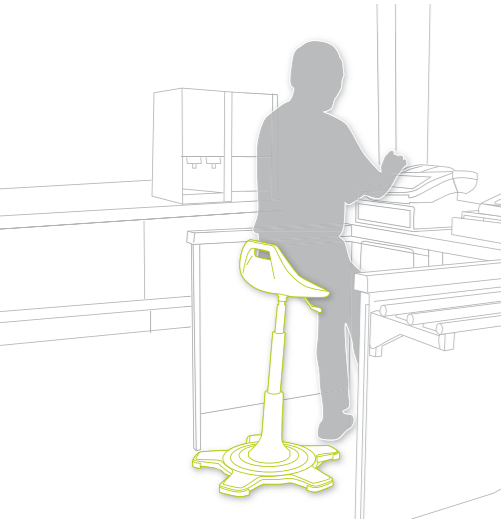

Support for your everyday work

Anyone who has to stand up for extended and monotonous periods of time needs support, since standing up motionless for a long time puts the body under a great deal of stress and strain. Our classic standing rests support the body and relieve the strain from the spinal column. The many different variations of base ensure that there is a version suitable for just about every use. Our industrial standing rests are extremely robust, and can stand up to even the toughest treatment. The industrial standing rest 2 is also available in an ESD version.

Functions (for precise details, see pages 16 – 17)

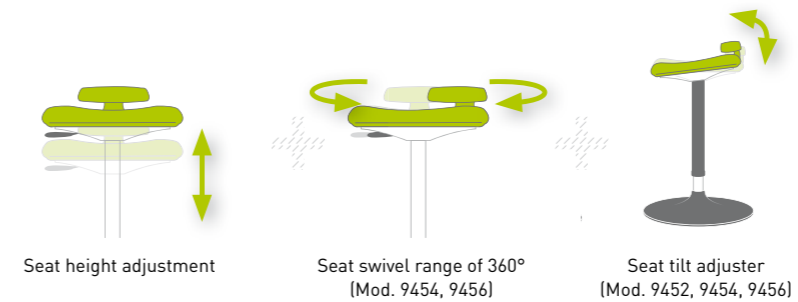

Seat cover materials and colours

Cover material	Black
Integral foam (PU)	
Order No.	2000



Standing aid for industrial application Stable and ultra-flat disc base

Seat height adjustment range: 650 to 850 mm.
Pneumatic spring. Seat can be tilted forwards by 10°. Seat swivel range of 360°. Seat made from integral foam and with integrated carry handle.

Design	Order no.
Integral foam, black	9454-2000



Standing aid for industrial application Collapsible

Seat height adjustment range: 650 to 850 mm.
Ratchet mechanism. Seat can be tilted forwards by 10°. Seat made from integral foam and with integrated carry handle.

Design	Order no.
Integral foam, black	9452-2000



Standing aid for industrial application Fold-away leg

Seat height adjustment range: 640 to 840 mm.
Pneumatic spring. Seat can be tilted forwards by 10°. Seat swivel range of 360°. Seat made from integral foam and with integrated carry handle.

Design	Order no.
Integral foam, black	9456-2000

 +32 (0)9 232 06 78

 info@awp.be

 Destelbergen



Flex / ESD Flex



The best support for sitting, standing and combined workplaces

Flex is a real all-rounder. It is the practical solution for workplaces where people have to sit as well as stand. To cope with this, Flex has a particularly wide range of heights that can be adjusted steplessly. Its ergonomic backrest and non-slip wave seat surface ensure that you feel completely safe and comfortable when you sit on the Flex. Comfort and resilience co-exist very happily in a Flex. Flex is at home in harsh working environments too. It is solidly built, and is extremely tough. Yet its upholstery is soft and boasts excellent ventilation, thanks to its wavy surface design. Flex is the practical solution when you need something light and uncomplicated.

Functions (for precise details, see pages 16–17)

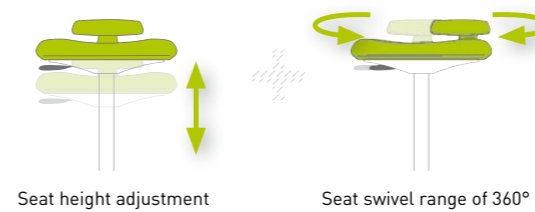

Finish and colour options for seat

Finish	Black
Integral foam	
Order no.	2000



Flex 1 with castors

Seat height adjustment range: 450 to 650 mm.

Design	Order no.
Integral foam, black	9408-2000



Flex 2 with glides

Seat height adjustment range: 510 to 780 mm.

Design	Order no.
Integral foam, black	9409-2000



Flex 3 with glides and foot ring

Seat height adjustment range: 510 to 780 mm.

Design	Order no.
Integral foam, black	9419-2000
ESD Integral foam, black with polished aluminium cross-conductive castors	9419E-2000

Everything you need to know about chairs

In line with our philosophy that our chairs should fit seamlessly into your working environment, we have provided you with some helpful information on the pages that follow.

The options guide will help you select the most appropriate accessories and designs for your situation. As a result, you should be able to tailor the chair in precise accordance with your needs.

The guide to finishes provides an overview of all the available finish options. This will enable you to determine which material is best suited to a particular environment.

You can also refer to our dimensions table for all the relevant dimensions information. In this way, you can be sure that the chair dimensions are appropriate for the amount of available space.

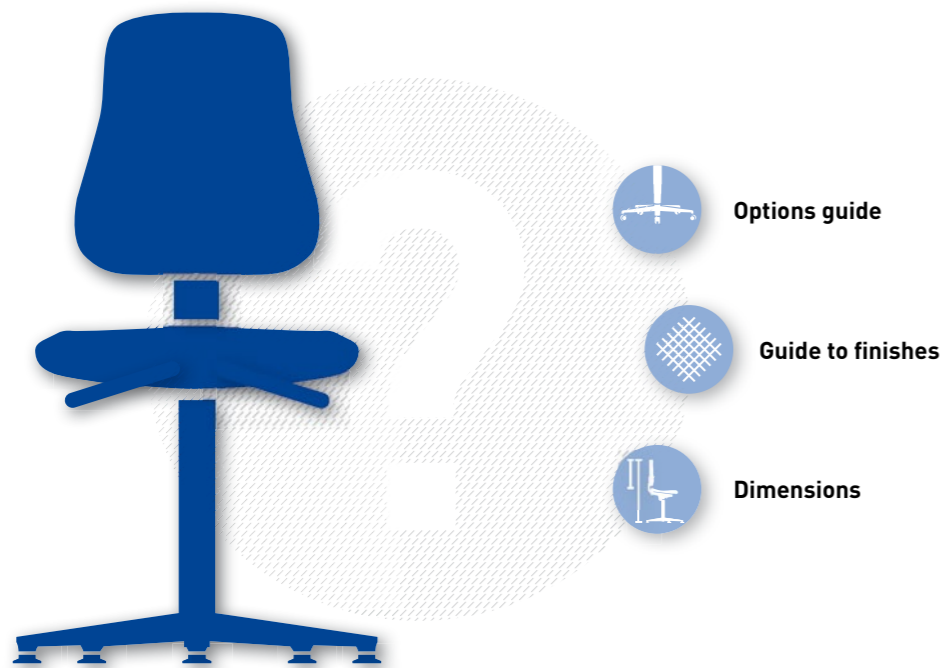

Options guide

Base frame

The base frame's shape and properties should be matched to the working environment in accordance with where it is going to be used. In the interests of ensuring maximum safety and convenience, Bimos offers a variety of base frames so that you can choose exactly the right one for your workplace situation.



Steel 5 star base
This 5 star base, which is made from high-strength sectional steel tubing, is particularly robust and durable. Its flat design pre-vents people from tripping over it. Ideally suited to: production and manufacturing environments.

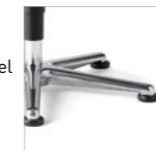

Aluminium 5 star base
5 star base made from polished aluminium. Highly suitable for use in laboratories or clean-rooms.



Disc base
This disc base has no corners or edges. This makes it impossible to trip over and very easy to clean. Therefore, it is particularly suited to working environments where large quantities of lint, dust or swarf are typical.

Armrests

If you have to remain seated for long periods, armrests will take the strain off your shoulders. Armrests can provide particularly effective support for detailed activities. However, they can also sometimes get in the way in situations where a high level of agility is required. That is why all our armrests are optional and do not pose any difficulties if you need to install them at a later date.



Ring-shaped armrests
The width of this ring-shaped armrest, which is made of plastic, can be adjusted by 20 mm.



Multifunction armrest
The height, width and depth of this armrest can all be adjusted to suit the individual user. The armrest pivots and can be locked into position.



Multifunction armrest ESD
The armrests made of conductive plastic can be adjusted in 4 dimensions.

Glide/astors



Glides
Our abrasion-resistant plastic glides have a large surface area and offer a superb level of stability. The flat design prevents you from tripping over them.



Castors
Dual-wheel safety castors with load-sensitive brakes have to be right for the floor. All Bimos chairs are supplied with soft castors for hard floors as standard. Hard castors for soft floors are also available as an option.



Stop & Go castors
So you want to stay put when you need to and the freedom to move unhindered when needs must? If so, then our Stop & Go castors offer the perfect solution. They can be retrofitted on all Bimos models.

Foot ring

According to German DIN standard 68877, any chair with a seat height of over 650 mm has to have a step. Whenever our chairs exceed this height, we install the best possible step. It may even make sense to include a step in the case of standard working heights. To cater for this requirement, we offer a foot ring that can be retrofitted.



Chrome-plated foot ring
This chrome-plated foot ring can be retrofitted by attaching it to the chair column. It is height-adjustable.



Labster foot ring
This plastic foot ring, which features an extra-large footrest area, has been specially designed for our specialist laboratory model, Labster, and cannot be used with any other model. The ring is height-adjustable.

Workshops for the disabled

Workshops for the disabled are subject to special safety requirements. That is why we offer special accessories for use in this kind of environment.



Full belt safety harness
This full belt safety harness holds the upper body upright so that the user cannot fall of their chair. The safety harness can be



Lap belt
This lap belt provides security for people who are particularly at risk, e.g. those who suffer from epileptic fits. The belt can be



Swivel lock
For some activities, a swivelling chair can be a bit of a nuisance (e.g. when you need to apply force). This product enables you to lock the chair in position using a lever. The swivel lock can be retrofitted.

Guide to finishes

The easy way to find the right finish for your working environment:

Wood

This washable material is particularly well suited to environments that contain aggressive substances. Wood is highly resistant, robust, durable and easy to clean. Although wooden chairs cost less, the hard surface does make them slightly less comfortable to sit on.

Laminated beech

Our laminated beech consists of multi-bonded wood. Its ergonomic design fits snugly against your spine. The surface is coated with a clear varnish.



Fabric upholstery

Our fabric upholstery is particularly recommended for use in clean working environments. This high-quality fabric upholstery is breathable and can both absorb and expel moisture. The extremely soft surface guarantees maximum comfort. The upholstery can be cleaned using commercially available upholstery cleaning products.

Duotec

Our Duotec cover fabric, which is 95% polyacrylic and 5% Lycra, is particularly soft, hard-wearing and breathable. A conductive ESD version of the Duotec fabric is also available. This version has additional metal fibres woven into it.

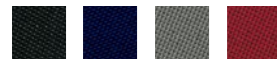

Genius

True to its name, this upholstery fabric really is a stroke of genius and is highly resistant. Thanks to its unique composition (50% polyamide, 33% new wool, 10% Visil and 7% rayon), Genius is 10 times more hard-wearing than conventional upholstery fabrics. This is backed up by its performance in the Martindale abrasion test (500,000 cycles).

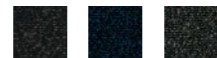

Magic

Magic is a great-feeling modern synthetic leather with a fine structure. By looking at it, it is difficult to tell the difference between genuine leather and Magic. This synthetic leather is extremely soft and comfortable. But in spite of that it is extremely hard-wearing. Magic is especially low-maintenance. It is washable, and resistant to oil and disinfectants. A black conductive ESD version (with carbon pigments) is also available for use in ESD areas.



Supertec

"Supertec" is an innovative cover material like no other upholstery surface. Supertec consists of a textile substrate covered with micro-studs. So Supertec combines the advantages of fabric and integral foam. Supertec is soft, comfortable and breathable. At the same time, it is very tough, cut resistant, non slip and easy to clean. Supertec is a world first among cover materials, and Bimos is the first manufacturer to use this material in workplace chairs.

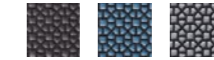

Integral foam

Integral foam is a good option for environments where the chair is likely to come into contact with aggressive substances such as oil, grease, swarf, mild acids and alkalis, moisture or flying sparks. The surface is highly resistant, extremely robust, washable and very easy to clean. Another plus point is the material's durability in that it can withstand pointed and sharp-edged objects. Thanks to its structured surface, integral foam has good climatic properties. A high level of comfort is guaranteed.

Integral foam – often known as PU or polyurethane foam – is extremely tough and easy to clean. Like our SoftTouch PU foam, integral foam is extraordinarily soft. A black conductive ESD version is also available for use in ESD areas.



Synthetic leather upholstery

Our synthetic leather upholstery is washable, resistant to disinfectants and easy to care for and clean. This soft and comfortable upholstery has a really nice feel to it. Nevertheless, there is still a risk of damage should it come into contact with extremely sharp-edged objects.

Skai

This synthetic leather upholstery is ultra hard-wearing. It is washable and the fact that it is resistant to disinfectants makes it extremely easy to care for. In terms of its look and feel, Skai is virtually indistinguishable from real leather. A black conductive ESD version of the Skai synthetic leather upholstery (with carbon pigments) is also available for use in ESD areas. Skai is particularly suitable for use in production, ESD, laboratory and cleanroom environments.

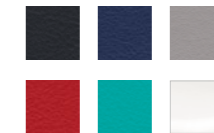

Production



ESD area



+32 (0)9 232 06 78



info@awp.be



Destelbergen



Dimensions

Neon	Seat width	Seat depth	BR height	Seat height	Ø 5 star base	Weight
9560	470 mm	420 – 480 mm	570 mm	450 – 620 mm	700 mm	18,0 kg
9561	470 mm	420 – 480 mm	570 mm	590 – 870 mm	700 mm	21,0 kg
9563	470 mm	420 – 480 mm	570 mm	450 – 620 mm	700 mm	18,0 kg
9570	470 mm	420 – 480 mm	570 mm	450 – 620 mm	700 mm	18,0 kg
9571	470 mm	420 – 480 mm	570 mm	590 – 870 mm	700 mm	21,0 kg
9573	470 mm	420 – 480 mm	570 mm	450 – 620 mm	700 mm	18,0 kg
Sintec	Seat width	Seat depth	BR height	Seat height	Ø 5 star base	Weight
9800	480 mm	430 mm	420 mm	430 – 580 mm	680 mm	11,5 kg
9801	480 mm	430 mm	420 mm	580 – 850 mm	680 mm	15,0 kg
9803	480 mm	430 mm	420 mm	430 – 580 mm	680 mm	12,0 kg
9810	480 mm	430 mm	420 mm	430 – 580 mm	680 mm	13,5 kg
9811	480 mm	430 mm	420 mm	580 – 850 mm	680 mm	17,0 kg
9813	480 mm	430 mm	420 mm	430 – 580 mm	680 mm	14,0 kg
9820	480 mm	430 mm	420 mm	430 – 580 mm	680 mm	13,5 kg
9821	480 mm	430 mm	420 mm	580 – 850 mm	680 mm	17,0 kg
9823	480 mm	430 mm	420 mm	430 – 580 mm	680 mm	14,0 kg
Nexxit	Seat width	Seat depth	BR height	Seat height	Ø 5 star base	Weight
9030	460 mm	400 – 460 mm	530 mm	450 – 600 mm	680 mm	15,0 kg
9033	460 mm	400 – 460 mm	530 mm	450 – 600 mm	680 mm	15,0 kg
9031	460 mm	400 – 460 mm	530 mm	570 – 820 mm	680 mm	18,0 kg
All-In-One Highline	Seat width	Seat depth	BR height	Seat height	Ø 5 star base	Weight
9640	450 mm	430 mm	600 mm	450 – 600 mm	680 mm	18,0 kg / PU 20,0 kg
9641	450 mm	430 mm	600 mm	570 – 830 mm	680 mm	21,0 kg / PU 23,0 kg
9643	450 mm	430 mm	600 mm	450 – 600 mm	680 mm	18,5 kg / PU 20,5 kg
All-In-One Trend	Seat width	Seat depth	BR height	Seat height	Ø 5 star base	Weight
9630	460 mm / PU 450 mm	450 mm / PU 430 mm	500 mm	450 – 600 mm	680 mm	17,0 kg / PU 19,0 kg
9631	460 mm / PU 450 mm	450 mm / PU 430 mm	500 mm	570 – 830 mm	680 mm	20,0 kg / PU 22,0 kg
9633	460 mm / PU 450 mm	450 mm / PU 430 mm	500 mm	450 – 600 mm	680 mm	17,5 kg / PU 19,5 kg
Isitec	Seat width	Seat depth	BR height	Seat height	Ø 5 star base	Weight
9603	440 mm	410 mm	340 mm	430 – 600 mm	640 mm	12,0 kg
9608	440 mm	410 mm	340 mm	430 – 600 mm	640 mm	12,0 kg
9613	440 mm	410 mm	340 mm	580 – 850 mm	680 mm	14,0 kg
Unitec	Seat width	Seat depth	BR height	Seat height	Ø 5 star base	Weight
9650 Wood	430 mm	400 mm	340 mm	440 – 620 mm	640 mm	10,5 kg
9650 Fabric, synth. leather	460 mm	470 mm	460 mm	440 – 620 mm	640 mm	12,0 kg
9650 PU	440 mm	410 mm	380 mm	440 – 620 mm	640 mm	11,5 kg
9651 Wood	430 mm	400 mm	340 mm	580 – 850 mm	680 mm	12,5 kg
9651 Fabric, synth. leather	460 mm	470 mm	460 mm	580 – 850 mm	680 mm	14,0 kg
9651 PU	440 mm	410 mm	380 mm	580 – 850 mm	680 mm	13,5 kg
9653 Wood	430 mm	400 mm	340 mm	440 – 620 mm	640 mm	10,5 kg
9653 Fabric, synth. leather	460 mm	470 mm	460 mm	440 – 620 mm	640 mm	12,0 kg
9653 PU	440 mm	410 mm	380 mm	440 – 620 mm	640 mm	11,5 kg
Stool	Seat width	Seat depth	BR height	Seat height	Ø 5 star base	Weight
9467 Wd., fab., synth. leath.	400 mm	400 mm	-	460 – 630 mm	640 mm	6,5 kg
9467 PU	350 mm	350 mm	-	460 – 630 mm	640 mm	6,5 kg
9468 Wd., fab., synth. leath.	400 mm	400 mm	-	460 – 630 mm	640 mm	7,0 kg
9468 PU	350 mm	350 mm	-	460 – 630 mm	640 mm	7,0 kg
9469 Wd., fab., synth. leath.	400 mm	400 mm	-	570 – 850 mm	690 mm	8,5 kg
9469 PU	350 mm	350 mm	-	570 – 850 mm	690 mm	8,5 kg
Footrests	Tread width	Tread depth	Frame width	Frame depth		Weight
9450	440 mm	340 mm	530 mm	520 mm	-	8,0 kg
9455	440 mm	340 mm	530 mm	520 mm	-	11,0 kg
Sintec 160	Seat width	Seat depth	BR height	Seat height	Ø 5 star base	Weight
9816	480 mm					

Production ESD area Laboratory Cleanroom Standing work

ESD Neon	Seat width	Seat depth	BR height	Seat height	Ø 5 star base	Weight
9560E	470 mm	420 – 480 mm	570 mm	450 – 620 mm	700 mm	18,0 kg
9561E	470 mm	420 – 480 mm	570 mm	590 – 870 mm	700 mm	21,0 kg
9563E	470 mm	420 – 480 mm	570 mm	450 – 620 mm	700 mm	18,0 kg
9570E	470 mm	420 – 480 mm	570 mm	450 – 620 mm	700 mm	18,0 kg
9571E	470 mm	420 – 480 mm	570 mm	590 – 870 mm	700 mm	21,0 kg
9573E	470 mm	420 – 480 mm	570 mm	450 – 620 mm	700 mm	18,0 kg
ESD Sintec	Seat width	Seat depth	BR height	Seat height	Ø 5 star base	Weight
9800E	480 mm	430 mm	420 mm	430 – 580 mm	680 mm	11,5 kg
9801E	480 mm	430 mm	420 mm	580 – 850 mm	680 mm	15,0 kg
9803E	480 mm	430 mm	420 mm	430 – 580 mm	680 mm	12,0 kg
9810E	480 mm	430 mm	420 mm	430 – 580 mm	680 mm	13,5 kg
9811E	480 mm	430 mm	420 mm	580 – 850 mm	680 mm	14,0 kg
9813E	480 mm	430 mm	420 mm	430 – 580 mm	680 mm	17,0 kg
9820E	480 mm	430 mm	420 mm	430 – 580 mm	680 mm	13,5 kg
9821E	480 mm	430 mm	420 mm	580 – 850 mm	680 mm	17,0 kg
9823E	480 mm	430 mm	420 mm	430 – 580 mm	680 mm	14,0 kg
ESD Nexxit	Seat width	Seat depth	BR height	Seat height	Ø 5 star base	Weight
9030E	460 mm	400 – 460 mm	530 mm	450 – 600 mm	680 mm	15,0 kg
9033E	460 mm	400 – 460 mm	530 mm	450 – 600 mm	680 mm	15,0 kg
9031E	460 mm	400 – 460 mm	530 mm	570 – 820 mm	680 mm	18,0 kg
ESD Basic	Seat width	Seat depth	BR height	Seat height	Ø 5 star base	Weight
9150E	460 mm	440 mm	430 mm	470 – 610 mm	680 mm	14,0 kg
9151E	460 mm	440 mm	430 mm	470 – 610 mm	680 mm	14,5 kg
9152E	460 mm	440 mm	430 mm	620 – 870 mm	680 mm	17,5 kg
9154E	460 mm	440 mm	530 mm	470 – 610 mm	680 mm	16,5 kg
9155E	460 mm	440 mm	530 mm	470 – 610 mm	680 mm	17,0 kg
9156E	460 mm	440 mm	530 mm	620 – 870 mm	680 mm	20,0 kg
9157E	460 mm	440 mm	530 mm	490 – 630 mm	680 mm	16,5 kg
9158E	460 mm	440 mm	530 mm	490 – 630 mm	680 mm	17,0 kg
9159E	460 mm	440 mm	530 mm	640 – 890 mm	680 mm	20,0 kg
ESD Unitec	Seat width	Seat depth	BR height	Seat height	Ø 5 star base	Weight
9650E	460 mm	470 mm	460 mm	440 – 590 mm	680 mm	13,0 kg
9651E	460 mm	470 mm	460 mm	580 – 850 mm	680 mm	15,0 kg
9653E	460 mm	470 mm	460 mm	440 – 590 mm	680 mm	13,0 kg
ESD Stool	Seat width	Seat depth	BR height	Seat height	Ø 5 star base	Weight
9467E	400 mm	400 mm	-	460 – 630 mm	680 mm	7,5 kg
9468E	400 mm	400 mm	-	460 – 630 mm	680 mm	8,0 kg
9469E	400 mm	400 mm	-	570 – 850 mm	680 mm	10,5 kg
ESD Footrest	Tread width	Tread depth	Frame width	Frame depth		Weight
9455E	440 mm	340 mm	530 mm	520 mm	-	11,0 kg
Labster	Seat width	Seat depth	BR height	Seat height	Ø 5 star base	Weight
9103	430 mm	410 mm	300 mm	400 – 510 mm (450 – 650 mm)	570 mm	10,0 kg
9101	430 mm	410 mm	300 mm	550 – 800 mm	570 mm	12,0 kg
9107	380 mm	380 mm	-	450 – 650 mm	490 mm	6,0 kg
9106	360 mm	300 mm	-	650 – 850 mm	490 mm	7,0 kg
Neon Laboratory	Seat width	Seat depth	BR height	Seat height	Ø 5 star base	Weight
9560	470 mm	420 – 480 mm	570 mm	450 – 620 mm	700 mm	18,0 kg
9561	470 mm	420 – 480 mm	570 mm	590 – 870 mm	700 mm	21,0 kg
9563	470 mm	420 – 480 mm	570 mm	450 – 620 mm	700 mm	18,0 kg
9570	470 mm	420 – 480 mm	570 mm	450 – 620 mm	700 mm	18,0 kg
9571	470 mm	420 – 480 mm	570 mm	590 – 870 mm	700 mm	21,0 kg
9573	470 mm	420 – 480 mm	570 mm	450 – 620 mm	700 mm	18,0 kg

Production ESD area Laboratory Cleanroom Standing work

Labsit	Seat width	Seat depth	BR height	Seat height	Ø 5 star base	Weight
9123/9123 E	460 mm	420 mm	420 mm	450 – 650 mm	640 mm	7,5 kg
9121/9121 E	460 mm	420 mm	420 mm	520 – 770 mm	640 mm	10,0 kg
9125/9125 E	460 mm	420 mm	420 mm	560 – 810 mm	640 mm	10,0 kg
9127/9127 E	400 mm	400 mm	–	450 – 650 mm	640 mm	7,0 kg
Nexxit Laboratory	Seat width	Seat depth	BR height	Seat height	Ø 5 star base	Weight
9030	460 mm	400 – 460 mm	530 mm	450 – 600 mm	680 mm	15,0 kg
9033	460 mm	400 – 460 mm	530 mm	450 – 600 mm	680 mm	15,0 kg
9031	460 mm	400 – 460 mm	530 mm	570 – 820 mm	680 mm	18,0 kg
Basic Laboratory	Seat width	Seat depth	BR height	Seat height	Ø 5 star base	Weight
9130	460 mm	440 mm	430 mm	470 – 610 mm	680 mm	14,0 kg
9131	460 mm	440 mm	430 mm	620 – 870 mm	680 mm	17,5 kg
9132	460 mm	440 mm	530 mm	470 – 610 mm	680 mm	16,5 kg
9133	460 mm	440 mm	430 mm	470 – 610 mm	680 mm	14,5 kg
9134	460 mm	440 mm	530 mm	470 – 610 mm	680 mm	17,0 kg
9135	460 mm	440 mm	530 mm	490 – 630 mm	680 mm	16,5 kg
9136	460 mm	440 mm	530 mm	640 – 890 mm	680 mm	20,0 kg
9137	460 mm	440 mm	530 mm	620 – 870 mm	680 mm	20,0 kg
9138	460 mm	440 mm	530 mm	490 – 630 mm	680 mm	17,0 kg
Cleanroom Plus	Seat width	Seat depth	BR height	Seat height	Ø 5 star base	Weight
9161	480 mm	470 mm	500 mm	440 – 565 mm	650 mm	14,5 kg
9181	480 mm	470 mm	380 mm	440 – 565 mm	650 mm	14,0 kg
9183	480 mm	470 mm	380 mm	630 – 890 mm	650 mm	17,0 kg
Cleanroom Basic	Seat width	Seat depth	BR height	Seat height	Ø 5 star base	Weight
9140	460 mm	440 mm	430 mm	470 – 610 mm	650 mm	14,5 kg
9141	460 mm	440 mm	430 mm	620 – 870 mm	650 mm	17,5 kg
9142	460 mm	440 mm	530 mm	470 – 610 mm	650 mm	17,0 kg
9143	460 mm	440 mm	530 mm	620 – 870 mm	650 mm	20,0 kg
9145	460 mm	440 mm	530 mm	490 – 630 mm	650 mm	17,0 kg
9146	460 mm	440 mm	530 mm	640 – 890 mm	650 mm	20,0 kg
Cleanroom stools	Seat width	Seat depth	BR height	Seat height	Ø 5 star base	Weight
9467R	400 mm	400 mm	–	460 – 630 mm	650 mm	6,5 kg
9468R	400 mm	400 mm	–	460 – 630 mm	650 mm	7,0 kg
9469R	400 mm	400 mm	–	570 – 850 mm	650 mm	8,5 kg
Fin	Seat width	Seat depth	BR height	Seat height	Ø 5 star base	Weight
9144	490 mm	145 mm	–	620 – 850 mm	525 x 355 mm	9,0 kg
ESD Fin	Seat width	Seat depth	BR height	Seat height	Ø 5 star base	Weight
9144E	490 mm	145 mm	–	620 – 850 mm	525 x 355 mm	9,0 kg
Labster standing rest	Seat width	Seat depth	BR height	Seat height	Ø 5 star base	Weight
9106	360 mm	380 mm	–	650 – 850 mm	490 mm	7,0 kg
9106E	360 mm	380 mm	–	650 – 850 mm	490 mm	7,0 kg
Standing rest	Seat width	Seat depth	BR height	Seat height	Ø 5 star base	Weight
9452	370 mm	240 mm	–	650 – 850 mm	420 x 460 mm	9,0 kg
9454	370 mm	240 mm	–	650 – 850 mm	470 mm	10,0 kg
9456	370 mm	240 mm	–	640 – 840 mm	460 x 440 mm	9,0 kg
ESD standing rest	Seat width	Seat depth	BR height	Seat height	Ø 5 star base	Weight
9454E	370 mm	240 mm	–	650 – 850 mm	470 mm	10,0 kg
Flex / ESD Flex	Seat width	Seat depth	BR height	Seat height	Ø 5 star base	Weight
9408/9408 E	360 mm	380 mm	–	450 – 650 mm	640 mm	10,0 kg
9409/9409 E	360 mm	380 mm	–	510 – 780 mm	640 mm	11,0 kg
9419/9419 E	360 mm	380 mm	–	510 – 780 mm	640 mm	13,0 kg

Thank you for reading our catalogue. We hope that you have been able to find the right seating solution for your personal needs and workplace requirements. Perhaps you still have some questions. If so, please contact your local retailer or the Bimos team, who will be happy to help.

We look forward to receiving your order.

Welcome at Bimos.

Bimos – a brand of
 Interstuhl Büromöbel GmbH & Co. KG
 Brühlstraße 21
 72449 Meßstetten-Tieringen, Germany
 Phone +49 7436 871-111
 Fax +49 7436 871-359
 info@bimos.de
 bimos.com

Your Bimos partner:



Subject to technical changes. Colour deviations possible due to printing methods.
 The paper used in the manufacture of this brochure was made from wood from responsibly managed, sustainable forests. 04/18 2W00_PR005_IAEN

